

STAINLESS STEEL FITTINGS

Racores Inoxidable
Edelstahl-Verbindungen
Raccords en Acier Inox

AISI 316L



¿ESTÁS PREPARADO
PARA DISFRUTAR DE NUESTRA NUEVA WEB?
+ RÁPIDA Y FUNCIONAL

ARE YOU READY?
NEW WEBSITE LAUNCHING COMING SOON!
BETTER & FASTER



CRIMP FITTINGS FOR HOSES

Conexiones para flexibles
Armaturen für Schlauchleitungen
Embouts à sertir pour flexibles

1

TRALE® RIGID PIPE/ PIPE FITTINGS DIN 2353/ FLARE FITTINGS JIC 37°

Tubo rígidoTRALE® / Racores DIN 2353 / Racores JIC 37°
RohrTRALE® / Verschraubungen für Rohr DIN 2353/ JIC - Verbindungen
Tube rigideTRALE® SCH / Embouts SCH / Brides SAE/ Colliers

2

SCH TRALE® RIGID PIPE/ SCH FITTINGS / SAE FLANGES / CLAMPS

Tubo rígidoTRALE® SCH / Racores SCH / Bidas SAE / Abrazaderas
Rohr SCHTRALE® / SCH Armaturen/ SAE-Flansche/ Schellen
Tube rigideTRALE® SCH / Embouts SCH / Brides SAE/ Colliers

3

ADAPTORS

Adaptadores
Adapter
Adapteurs

4

WELDING FITTINGS

Racores soldables
Schweißverschraubungen
Raccords à souder

5

INDUSTRIAL FITTINGS

Racores industriales
Für den industriellen Einsatz
Raccords industriels

6

ACCESSORIES

Accesorios
Zubehör
Accessoires

7

HYDRAULIC COMPONENTS AISI 316

Componentes hidráulicos AISI 316
Hydraulische Komponenten
Composants Hydrauliques AISI 316

8

FLOW MEASURING

Metrología
Messtechnik
Test du circuit hydraulique

9

TWIN FERRULE FITTINGS TRALE® LOK

Racor doble anilloTRALE® Lok
Verschraubungen für Doppelklemmring TRALE® Lok
Raccord double bagueTRALE® Lok

10

STANDARD SERIES 23

Conexiones Standard
Standardserie
Embouts série standard

FITTINGS BW SERIES R12/4SP/4SH NO SKIVE 42

Conexiones Serie BW R12/4SP/4SH No Pelar
Armaturen Serie BW R12/4SP/4SH ohne Schälung
Embouts R12/4SP/4SH Série BW Sans dénuder

INTERLOCK SERIES 46

Conexiones Interlock
Armaturen Interlock
Embouts Interlock

ONE PIECE FITTINGS 43 SERIES R1AT/ R2AT/1SN/2SN/R16/2SC/R17 51

Conexiones una sola pieza Serie 43 R1AT/
R2AT/1SN/2SN/R16/2SC/R17
Einteilige Armaturen Serie 43 R1AT/
R2AT/1SN/2SN/R16/2SC/R17
Embouts pré-sertis R1AT/R2AT/1SN/2SN/
R16/2SC/R17 Série 43

ONE PIECE FITTINGS BWS SERIES 3SP/4SP/R12/4SH NO SKIVE 57

Conexiones una sola pieza Serie BWS 3SP/4SP/R12/4SH
No Pelar
Einteilige Armaturen Serie BWS 3SP/4SP/R12/4SH
ohne Schälung
Embouts pré-sertis Série BWS 3SP/4SP/R12/4SH
Sans dénuder

ONE PIECE FITTINGS R7/R8 & ELASTOMER BRAID OF STEEL WIRE 63

Conexiones una sola pieza R7/ R8/ Elastómero
malla metálica
Einteilige Armaturen R7/ R8 und Elastomer/
Metallumfl.
Embouts pré-sertis R7/R8 et Elastomère tresse
métallique

ONE PIECE FITTINGS FOR SMOOTH PTFE/ R14 68

Conexiones una sola pieza PTFE Liso / R14
Einteilige Armaturen PTFE-Glattschlauch/ R14
Embouts pré-sertis pour PTFE lisse/ R14

ONE PIECE FITTINGS FOR CONVOLUTED PTFE 73

Conexiones una sola pieza PTFE Corrugado
Einteilige Armaturen PTFE-Wellschlauch
Embouts pré-sertis pour PTFE convoluté

ONE PIECE FITTINGS BW SERIES R12/4SP/4SH NO SKIVE 78

Conexiones una sola pieza Serie BW R12/4SP/4SH No Pelar
Einteilige Armaturen Serie BW R12/4SP/4SH ohne
Schälung
Embouts pré-sertis R12/4SP/4SH Série BW Sans
dénuder

ONE PIECE FITTINGS BW+ SERIES R13/R15 NO SKIVE

Conexiones una pieza Serie BW+ R13/R15 No Pelar
Armaturen Serie BW+ R13/R15 ohne Schälung
Embouts R13/R15 Série BW+ Sans denuder

FERRULES FOR ONE PIECE FITTINGS 87

Casquillos para conexiones una sola pieza
Pressfassungen für einteilige Armaturen
Jupes pour embouts pré-sertis

REUSABLE SERIES 89

Conexiones Reusables
Schraubarmaturen
Embouts série récupérable

PUSH-ON FITTINGS 92

Conexiones Push-On
Aufsteck-Armaturen
Embouts Push-On

HIGH PRESSURE 700 BAR FITTINGS 93

Conexiones Alta Presión (700 bar)
Armaturen Hochdruck (700bar)
Embouts haute pression 700 bar

01

CRIMPING FITTINGS FOR HOSES

Conexiones para Flexibles
Pressfassungen für Schlauchleitungen
Embouts à sertir pour flexibles



STANDARD SERIES

Serie Standard



TrAle®

TrAle® GOLD

GREENLINE

SAE 100 R6	EN 854 2TE	EN 854 3TE	EN 857 1SC SUPERSERVICE 1SC 155°	EN 853 1SN SAE 100 R1AT 15NK	EN 853 2SN SAE 100 R2AT 2SNK	EN 857 2SC SUPERSERVICE 2SC 155°
81014		ZPF22120...	ZSC2112...	ZSC2112/ZPF22120	ZPF22120...	

EN 853 2ST SAE100 R2A	EN 856 4SP SAE 100 R9R	EN 856 R12 SAE 100	3SP	EN 856 4SP SAE 100 R9R	EN 856 4SH	EN856 R12 SAE 100	EN 856 R13 SAE 100	SAE 100 R15
ZPF12240...			NO PELAR NO SKIVE		ZPF2224...			3/4"-1"

SAE 100 R7 EN 855	SAE 100 R8 EN 855	Metallic 1 braid	Metallic 2 braid	Ecology 250
81014...		81014...	ZPF1224	Z2120...

Smooth PTFE R14 1 braid	Convuluted PTFE Standard	PTFLEX	Smooth PTFE R14 1 braid	Smooth PTFE 2 braid	Standard Convuluted PTFE	Fiberglass Convuluted PTFE	Antistatic Convuluted PTFE
88040... NEW	88041... NEW	81041...	81040...	81045...	81041...		

TrAle®

TrAle® GOLD

GREENLINE

BW SERIES NO SKIVE

Serie BW no pelar

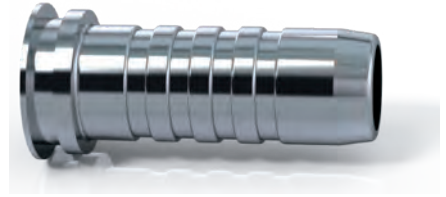

EN 856
4SP
SAE 100



EN 856
4SH



EN 856
R12
SAE 100



EN 856
R13
SAE 100



SAE 100
R15



ZAC68010



ZAC68010



ZAC68010



ZAC69010



ZAC69010

1" 1/4-1" 1/2-2"

INTERLOCK SERIES

Serie Interlock



EN 856
4SH



EN 856
R13
SAE 100



SAE 100
R15

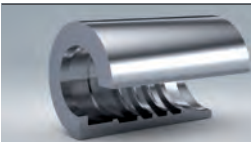

ZA61010...

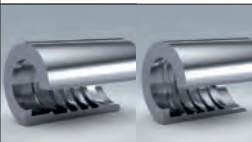

ZA61010...
Z61010...

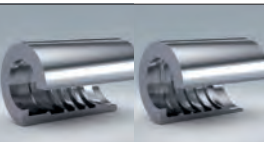

ZA61010...
Z61010...

ONE PIECE SERIES

Serie Compacta
Einteilige Armaturen
Série Pré-sertis

- One piece fittings 1SC / 1SN / 2SC / R6 / 2TE
Conexiones compactas 1SC / 1SN / 2SC / R6 / 2TE
Einteilige Armaturen 1SC / 1SN / 2SC / R6 / 2TE
Embouts pré-sertis 1SC / 1SN / 2SC / R6 / 2TE

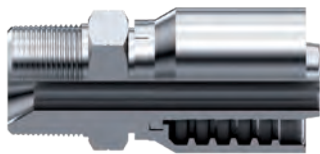

EN 857 1SC	EN 853 1 SN SAE 100 R1AT	EN 857 2SC	EN 854 SAE 100 R6	EN 854 2TE
---------------	-----------------------------------	---------------	-------------------------	---------------

- One piece fittings 43 Series R1AT / R2AT / 1SN / 2SN / R16 / 2SC / 3TE / R17
Conexiones compactas Serie 43 R1AT / R2AT / 1SN / 2SN / R16 / 2SC / 3TE / R17
Einteilige Armaturen Serie 43 R1AT / R2AT / 1SN / 2SN / R16 / 2SC / 3TE / R17
Embouts pré-sertis R1AT / R2AT / 1SN / 2SN / R16 / 2SC / 3TE Série 43/R17

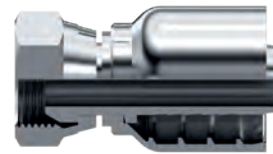

EN 853 1SN SAE 100R1AT	EN 853 2 SN SAE 100 R2AT	EN 857 2SC SAE 100 R16	SUPERSERVICE 155° 2SC	3TE
------------------------------	-----------------------------------	---------------------------------	-----------------------------	-----

- One piece fittings Standar BWS Series NON SKIVE 3SP / 4SP / 4SH / R12
Conexiones compactas Serie BWS NO PELAR 3SP / 4SP / 4SH / R12
Einteilige Armaturen Serie BWS OHNE SCHÄLUNG 3SP / 4SP / 4SH / R12
Embouts pré-sertis BWS SANS DÉNUDÉ 3SP / 4SP / 4SH / R12

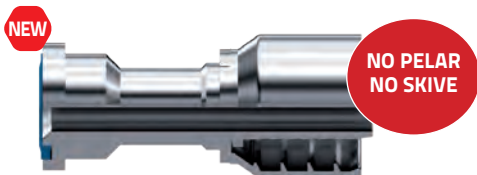

3SP	EN 856 4SP SAE 100 R9R	EN 856 4SH	EN856 R12 SAE 100	EN 856 R13 SAE 100	SAE 100 R15
-----	---------------------------------	---------------	-------------------------	--------------------------	----------------

- One piece fittings BW+ Series NON SKIVE R13 / R15
Conexiones compactas Serie BW+ NO PELAR R13 / R15
Einteilige Armaturen Serie BW+ OHNE SCHÄLUNG R13 / R15
Embouts pré-sertis BW+ SANS DÉNUDÉ R13 / R15



EN 856 SAE 100 R13	SAE 100 R15
--------------------------	----------------

- Piece fittings R7 / R8 & braid of steel wire
Conexiones compactas R7 / R8 y elastómero malla metálica
Einteilige Armaturen R7/ R8 und Elastomer/Metallumfl.
Embouts pré-sertis R7 / R8 et tresse métallique



SAE 100 R7	SAE 100 R8	Metallic braid elastomer
---------------	---------------	--------------------------------

- One piece fittings for smooth PTFE R14
Conexiones compactas PTFE liso R14
Einteilige Armaturen PTFE-Glattschlauch R14
Embouts pré-sertis pour PTFE lisse R14



Smooth PTFE 1 braid

- One piece fittings for convoluted PTFE
Conexiones compactas PTFE corrugado
Einteilige Armaturen PTFE-Wellschlauch
Embouts pré-sertis pour PTFE convolute



Convoluted
PTFE

- One piece fittings BW Series R12 / 4SP / 4SH
Conexiones compactas Serie BW R12 / 4SP / 4SH
Einteilige Armaturen Serie BW R12/4SP/4SH
Embouts pré-sertis R12 / 4SP / 4SH Série BW

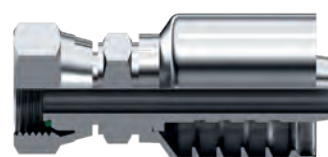

EN 856 R12	EN 856 4SP	4 SH
---------------	---------------	------

STANDARD SERIES

Conexiones Standard
Standardserie
Embouts série standard

Crimping ferrules ▪ Casquillos para prensar ▪ Pressfassungen ▪ Jupes à sertir

23



BSP Fittings ▪ Conexiones BSP ▪ Armaturen BSP ▪ Embouts BSP

26



NPT-NPSM Fittings ▪ Conexiones NPT-NPSM ▪ Armaturen NPT-NPSM ▪ Embouts NPT-NPSM

30



JIC 37° Fittings ▪ Conexiones JIC 37° ▪ Armaturen DKJ ▪ Embouts JIC 37°

31



Metric fittings ▪ Conexiones Métricas DIN 2353 ▪ Armaturen DKO ▪ Embouts Métriques

33



Standpipes ▪ Espigas lisas ▪ Stutzen glatt ▪ Embouts lisses

36



Other Fittings ▪ Conexiones Varias ▪ Verschiedene Armaturen ▪ Autres

37



Banjos ▪ Orientables ▪ Ringaugen ▪ Embouts Banjo

38



STANDARD SERIES

Conexiones Standard
Standardserie
Embouts série standard

PIPE
FITTINGS

Hydrowashing machine couplings ▪ Terminales hidrolavadoras ▪ Armaturen für Waschgeräte ▪ Embouts pour hydronettoyage

38



83050

KZTHAP

PIPE
FITTINGS II

SAE Flanges/Code 61 & 62 ▪ Bidas SAE ▪ SAE-Flansche ▪ Brides SAE

39



84182

84183

84184

84282

84283

84284

ADAPTORS

SAE Flanges for hoses ▪ Bidas para flexibles ▪ Flansche für Schlauch ▪ Brides SAE pour flexibles

40



ZBBP

ZBBE

ZTB

ZBCE

JBR

ORING

WELDING
FITTINGS

ORFS Fittings ▪ Conexiones ORFS ▪ ORFS-Armaturen ▪ Embouts ORFS

41



84901

84912

84907

84908

INDUSTRIAL
FITTINGS

O`Ring Boss Fittings ▪ Conexiones O`Ring Boss ▪ O`Ring Boss-Armaturen ▪ Embouts O`Ring Boss

41



84712

ACCESSORIES

CONTROL
COMPONENTS

FLOW
MEASURING

TRALE LOK

FITTINGS BW SERIES R12/4SP/4SH NO SKIVE

Conexiones Serie BW R12/4SP/4SH No Pelar
 Armaturen Serie BW R12/4SP/4SH ohne Schälung
 Embouts R12/4SP/4SH Série BW Sans dénuder

Ferrules for fittings BW series ▪ Casquillos para conexiones serie BW ▪ Pressfassungen für Armaturen Serie BW ▪ Jupes pour embouts série BW

42



ZAC68010

ZAC69010

BSP fittings ▪ Conexiones BSP ▪ Armaturen BSP ▪ Embouts BSP

42



Z66117

Z66112

Z66410

Z66118

NPT/NPSM fittings ▪ Conexiones NPT/NPSM ▪ Armaturen NPT/NPSM ▪ Embouts NPT/NPSM

43



Z66461

Z66161

JIC 37° fittings ▪ Conexiones JIC 37° ▪ Armaturen JIC 37° ▪ Embouts JIC

43



Z66242

Z66138

Z66139

Z66141

ORFS fittings ▪ Conexiones ORFS ▪ Armaturen ORFS ▪ Embouts ORFS

44



Z66901

Z66907

Z66908

Z66912

Metric fittings ▪ Conexiones Métricas DIN 2353 ▪ Armaturen metr. DIN 2353 ▪ Embouts Métriques

44



Z66204

Z66205

Z66206

Z66203

SAE Flanges/ Code 61 & 62 ▪ Bidas SAE ▪ SAE-Flansche ▪ Brides SAE

45



Z66182

Z66183

Z66184

Z66282

Z66283

Z66284

INTERLOCK SERIES

Conexiones Interlock
Armaturen Interlock
Embouts Interlock

PIPE
FITTINGS

Interlock Crimping ferrules ▪ Casquillos Interlock ▪ Pressfassungen Interlock ▪ Jupes à sertir Interlock

46



Z61010

Z61010

PIPE
FITTINGS II

Interlock BSP & NPT fittings ▪ Conexiones BSP y NPT ▪ Armaturen Interlock BSP, NPT ▪ Embouts à sertir Interlock BSP et NPT

46



Z64100

Z64107

Z64112

Z64108

Z64161

Z64500

Z64507

Z64508

ADAPTORS

Interlock JIC 37° fittings ▪ Conexiones JIC 37° ▪ Armaturen Interlock JIC 37° ▪ Embouts à sertir Interlock JIC

48



Z64242

Z64142

Z64140

Z64138

Z64139

WELDING
FITTINGS

Interlock Metric fittings ▪ Conexiones Métricas DIN 2353 ▪ Armaturen Interlock metr. ▪ Embouts Métrique Interlock

49



Z64204

Z64205

Z64206

Z64203

INDUSTRIAL
FITTINGS

Interlock ORFS fittings ▪ Conexiones ORFS ▪ Armaturen Interlock ORFS ▪ Embouts à sertir Interlock ORFS

49



Z64901

Z64912

Z64907

Z64908

ACCESSORIES

Interlock SAE Flanges/ Code 61 & 62 ▪ Bridas SAE ▪ SAE-Flansche ▪ Brides SAE Interlock

50



Z64182

Z64183

Z64184

Z64282

Z64283

Z64284

CONTROL
COMPONENTS

FLOW
MEASURING

TRALE LOK

ONE PIECE FITTINGS 43 SERIES R1AT/R2AT/1SN/2SN/R16/2SC/R17

Conexiones una sola pieza Serie 43 R1AT/R2AT/1SN/2SN/R16/2SC/R17

Einteilige Armaturen Serie 43 R1AT/R2AT/1SN/2SN/R16/2SC/R17

Embouts pré-sertis R1AT/R2AT/1SN/2SN/R16/2SC/R17 Série 43

One piece JIC 37° fittings ▪ Conexiones una sola pieza JIC 37° ▪ Einteilige Armaturen JIC 37° ▪ Embouts pré-sertis JIC 37°

51



PIPE
FITTINGS

One piece ORFS fittings ▪ Conexiones una sola pieza ORFS ▪ Einteilige Armaturen ORFS ▪ Embouts pré-sertis ORFS

52



PIPE
FITTINGS II

One piece NPT-NPSM fittings ▪ Conexiones una sola pieza NPT-NPSM ▪ Einteilige Armaturen NPT-NPSM ▪ Embouts pré-sertis NPT-NPSM

53



ADAPTORS

One piece SAE Flanges fittings ▪ Conexiones una sola pieza Bidas SAE ▪ Einteilige Armaturen SAE-Flansche ▪ Embouts pré-sertis Bidas SAE

54



WELDING
FITTINGS

One piece Metric fittings ▪ Conexiones una sola pieza Métricas ▪ Einteilige Armaturen metr. ▪ Embouts pré-sertis Métriques

55



INDUSTRIAL
FITTINGS

One piece BSP fittings ▪ Conexiones una sola pieza BSP ▪ Einteilige Armaturen BSP ▪ Embouts pré-sertis BSP

56



ACCESSORIES

CONTROL
COMPONENTS

FLOW
MEASURING

TRALE LOK

ONE PIECE FITTINGS BWS SERIES 3SP/4SP/R12/4SH NO SKIVE

Conexiones una sola pieza Serie BWS 3SP/4SP/R12/4SH No Pelar
Einteilige Armaturen Serie BWS 3SP/4SP/R12/4SH ohne Schälung
Embouts pré-sertis Série BWS 3SP/4SP/R12/4SH Sans dénuder

One piece JIC 37° fittings ▪ Conexiones una sola pieza JIC 37° ▪ Einteilige Armaturen JIC 37° ▪ Embouts pré-sertis JIC 37°

57



One piece ORFS fittings ▪ Conexiones una sola pieza ORFS ▪ Einteilige Armaturen ORFS ▪ Embouts pré-sertis ORFS

58



One piece NPT-NPSM fittings ▪ Conexiones una sola pieza NPT-NPSM ▪ Einteilige Armaturen NPT-NPSM ▪ Embouts pré-sertis NPT-NPSM

59



One piece SAE Flanges fittings/ Code 61 & 62 ▪ Conexiones una sola pieza Bridas SAE ▪ Einteilige Armaturen SAE-Flansche ▪ Embouts pré-sertis Brides SAE

60



One piece Metric fittings ▪ Conexiones una sola pieza Métricas ▪ Einteilige Armaturen metr. ▪ Embouts pré-sertis Métriques

61



One piece BSP fittings ▪ Conexiones una sola pieza BSP ▪ Einteilige Armaturen BSP ▪ Embouts pré-sertis BSP

62



ONE PIECE FITTINGS R7/R8 & ELASTOMER BRAID OF STEEL WIRE

Conexiones una sola pieza R7/ R8/ Elastómero malla metálica
Einteilige Armaturen R7/ R8 und Elastomer/Metallumfl.
Embouts pré-sertis R7/R8 et Elastomère tresse métallique

37° JIC One piece fittings R7/R8 ▪ Conexiones una sola pieza R7/R8 JIC 37° ▪ Einteilige Armaturen R7/R8 JIC 37° ▪ Embouts pré-sertis R7/R8 JIC 37°

63



87142 87138 87139 87140 87242

ORFS One piece fittings R7/R8 ▪ Conexiones una sola pieza R7/R8 ORFS ▪ Einteilige Armaturen R7/R8 ORFS ▪ Embouts pré-sertis R7/R8 ORFS

64



87900 87907 87908 87912

NPT-NPSM One piece fittings R7/R8 ▪ Conexiones una sola pieza R7/R8 NPT-NPSM ▪ Einteilige Armaturen R7/R8 NPT-NPSM ▪ Embouts pré-sertis R7/R8 NPT-NPSM

65



87261 87262 87263 87161 87361

Metric One piece fittings R7/R8 ▪ Conexiones una sola pieza R7/R8 Métricas ▪ Einteilige Armaturen R7/R8 metr. ▪ Embouts pré-sertis R7/R8 Métriques

66



87804 87305 87306 87203

BSP One piece fittings R7/R8 ▪ Conexiones una sola pieza R7/R8 BSP ▪ Einteilige Armaturen R7/R8 BSP ▪ Embouts pré-sertis R7/R8 BSP

67



87100 87107 87108 87112 87400

ONE PIECE FITTINGS FOR SMOOTH PTFE / R14

Conexiones una sola pieza PTFE Liso / R14
Einteilige Armaturen PTFE-Glattschlauch / R14
Embouts pré-sertis pour PTFE lisse / R14

PIPE
FITTINGS

37° JIC One piece fittings smooth PTFE / R14 ▪ Conexiones una sola pieza PTFE liso / R14 JIC 37° ▪ Einteilige Armaturen PTFE-Glattschlauch / R14 JIC 37° ▪ Embouts pré-sertis PTFE lisse / R14 JIC 37°

68



86142 86138 86139 86140 86242

PIPE
FITTINGS II

ORFS One piece fittings smooth PTFE / R14 ▪ Conexiones una sola pieza PTFE liso / R14 ORFS ▪ Einteilige Armaturen PTFE-Glattschlauch / R14 ORFS ▪ Embouts pré-sertis PTFE lisse / R14 ORFS

69



86900 86907 86908 86912

ADAPTORS

NPT-NPSM One piece fittings smooth PTFE / R14 ▪ Conexiones una sola pieza PTFE liso / R14 NPT-NPSM ▪ Einteilige Armaturen PTFE-Glattschlauch / R14 NPT-NPSM ▪ Embouts pré-sertis PTFE lisse / R14 NPT-NPSM

70



86261 86262 86263 86161 86361

WELDING
FITTINGS

Metric One piece fittings smooth PTFE / R14 ▪ Conexiones una sola pieza PTFE liso / R14 Métricas ▪ Einteilige Armaturen PTFE-Glattschlauch / R14 metr. ▪ Embouts pré-sertis PTFE lisse / R14 Métriques

71



86804 86305 86306 86203

INDUSTRIAL
FITTINGS

BSP One piece fittings smooth PTFE / R14 ▪ Conexiones una sola pieza PTFE liso / R14 BSP ▪ Einteilige Armaturen PTFE-Glattschlauch / R14 BSP ▪ Embouts pré-sertis PTFE lisse / R14 BSP

72



86100 86107 86108 86112 86400

ACCESSORIES

CONTROL
COMPONENTS

FLOW
MEASURING

TRALE LOK

ONE PIECE FITTINGS FOR CONVOLUTED PTFE

Conexiones una sola pieza PTFE Corrugado
Einteilige Armaturen PTFE-Wellschlauch
Embouts pré-sertis pour PTFE convoluté

One piece fittings for convoluted PTFE JIC 37° ▪ Conexiones una sola pieza PTFE Corrugado JIC 37° ▪ Einteilige Armaturen PTFE-Wellschlauch JIC 37° ▪ Embouts pré-sertis pour PTFE convoluté JIC 37°

73



85142 85138 85139 85140 85242

PIPE
FITTINGS

One piece fittings for convoluted PTFE ORFS ▪ Conexiones una sola pieza PTFE Corrugado ORFS ▪ Einteilige Armaturen PTFE-Wellschlauch ORFS ▪ Embouts pré-sertis pour PTFE convoluté ORFS

74



85900 85907 85908 85912

PIPE
FITTINGS II

One piece fittings for convoluted PTFE NPT-NPSM ▪ Conexiones una sola pieza PTFE Corrugado NPT-NPSM ▪ Einteilige Armaturen PTFE-Wellschlauch NPT-NPSM ▪ Embouts pré-sertis pour PTFE convoluté NPT-NPSM

75



85261 85262 85263 85161 85361

ADAPTORS

One piece fittings for convoluted PTFE Metrical ▪ Conexiones una sola pieza PTFE Corrugado Métricas ▪ Einteilige Armaturen PTFE-Wellschlauch metr. ▪ Embouts pré-sertis pour PTFE convoluté Métriques

76



85804 85305 85306 85203

WELDING
FITTINGS

One piece fittings for convoluted PTFE BSP ▪ Conexiones una sola pieza PTFE Corrugado BSP ▪ Einteilige Armaturen PTFE-Wellschlauch BSP ▪ Embouts pré-sertis pour PTFE convoluté BSP

77



85100 85107 85108 85112 85400

INDUSTRIAL
FITTINGS

ACCESSORIES

CONTROL
COMPONENTS

FLOW
MEASURING

TRALE LOK

ONE PIECE FITTINGS BW SERIES R12/4SP/4SH NO SKIVE

Conexiones una sola pieza Serie BW R12/4SP/4SH No Pelar
Einteilige Armaturen Serie BW R12/4SP/4SH ohne Schälung
Embouts pré-sertis R12/4SP/4SH Série BW Sans dénuder

One piece JIC 37° fittings ▪ Conexiones una sola pieza JIC 37° ▪ Einteilige Armaturen JIC 37° ▪ Embouts pré-sertis JIC

78



One piece ORFS fittings ▪ Conexiones una sola pieza ORFS ▪ Einteilige Armaturen ORFS ▪ Embouts pré-sertis ORFS

79



One piece NPT/NPSM fittings ▪ Conexiones una sola pieza NPT/NPSM ▪ Einteilige Armaturen NPT/NPSM ▪ Embouts pré-sertis NPT/NPSM

79



One piece SAE Flanges/ Code 61 & 62 ▪ Conexiones una sola pieza Bidas SAE ▪ Einteilige Armaturen SAE-Flansche ▪ Brides SAE pré-serties

80



One piece Metric fittings ▪ Conexiones una sola pieza Métricas DIN 2353 ▪ Einteilige Armaturen metr. DIN 2353 ▪ Embouts pré-sertis Métriques

81



One piece BSP fittings ▪ Conexiones una sola pieza BSP ▪ Einteilige Armaturen BSP ▪ Embouts pré-sertis BSP

82



ONE PIECE FITTINGS BW+ SERIES R13/R15 NO SKIVE

Conexiones una pieza Serie BW+ R13/R15 No Pelar

Armaturen Serie BW+ R13/R15 ohne Schälung

Embouts R13/R15 Série BW+ Sans denuder

JIC 37° fittings ▪ Conexiones JIC 37° ▪ Armaturen JIC 37° ▪ Embouts JIC 37°



Z69242

Z69141

Z69138

Z69139

ORFS fittings ▪ Conexiones ORFS ▪ Armaturen ORFS ▪ Embouts ORFS



Z69901

Z69907

Z69908

Z69912

NPT/NPSM fittings ▪ Conexiones NPT/NPSM ▪ Armaturen NPT/NPSM ▪ Embouts NPT/NPSM



Z69361

Z69161

SAE Flanges ▪ Bidas SAE ▪ SAE-Flansche ▪ Brides SAE



Z69282

Z69283

Z69284

BSP fittings ▪ Conexiones BSP ▪ Armaturen BSP ▪ Embouts BSP



Z69112

Z69410

Z69117

Z69118

FERRULES FOR ONE PIECE FITTINGS

Casquillos para conexiones una sola pieza
Pressfassungen für einteilige Armaturen
Jupes pour embouts pré-sertis

Ferrules for one piece fittings ▪ Casquillos para Conexiones una sola pieza ▪ Pressfassungen für einteilige Armaturen ▪ Jupes pour embouts pré-sertis



ZPFC2212



ZPF2224



88012



88040



88041



ZSCC2112



ZAC68010



ZAC69010

REUSABLE SERIES

Conexiones Reusables
Schraubarmaturen
Embouts série récupérable

Crimping ferrules ▪ Casquillos reusables ▪ Wiederverwendbare Pressfassungen ▪ Jupes à sertir | 89



Z1G...R1T

Z1G...R2T

Reusable BSP ▪ Conexiones BSP ▪ Wiederverwendbare Armaturen BSP ▪ Récuperables BSP | 89



Z3G

Z90G

Z2G

Reusable JIC 37° ▪ Conexiones JIC 37° ▪ Wiederverwendbare Armaturen JIC 37 ▪ Récuperables JIC 37° | 90



Z3J

Z2J

Z3J90

Z3J45

Reusable NPT ▪ Conexiones NPT ▪ Wiederverwendbare Armaturen NPT ▪ Récuperables NPT | 90



Z2NPT

Reusable Metric ▪ Conexiones Métricas ▪ Wiederverwendbare Metrischen Armaturen ▪ Récuperables Métriques | 90



ZE

Reusable R5 ▪ Conexiones R5 ▪ Wiederverwendbare Armaturen R5 ▪ Récuperables R5 | 91



Z3J...R5

Z3J90...R5

Z3J45...R5

Z2P...R5

PUSH-ON FITTINGS

Conexiones Push-On
Aufsteck-Armaturen
Embouts Push-On

PIPE
FITTINGS

Push-on BSP fittings ▪ Conexiones Push-On BSP ▪ Aufsteck-Armaturen BSP ▪ Embouts Push-on BSP

92



89100

89112

PIPE
FITTINGS II

Push-on 37° JIC fittings ▪ Conexiones Push-On JIC 37° ▪ Aufsteck-Armaturen JIC 37° ▪ Embouts Push-on JIC 37°

92



89142

89140

ADAPTORS

Push-on NPT fittings ▪ Conexiones Push-On NPT ▪ Aufsteck-Armaturen NPT ▪ Embouts Push-on NPT

92



89161

WELDING
FITTINGS

Push-on Metric fittings ▪ Conexiones Push-On Métricas ▪ Aufsteck-Armaturen metr. DIN 2383 ▪ Embouts Push-on Métriques

92



89804

89203

INDUSTRIAL
FITTINGS

ACCESSORIES

CONTROL
COMPONENTS

FLOW
MEASURING

TRAILER LOK

HIGH PRESSURE 700 BAR FITTINGS

Conexiones Alta Presión (700 bar)

Armaturen Hochdruck (700bar)

Embouts haute pression 700 bar

Ferrules ▪ Casquillos para presnar ▪ Pressfassungen ▪ Jupes à sertir

93



Z71012

BSP Fittings ▪ Conexiones BSP ▪ Armaturen BSP ▪ Embouts BSP

93



Z74100

Z74112

NPSM - NPT Fittings ▪ Conexiones NPSM - NPT ▪ Armaturen NPSM - NPT ▪ Embouts NPSM - NPT

93



Z74261

Z74161

JIC 37° Fittings ▪ Conexiones JIC 37° ▪ Armaturen JIC 37° ▪ Embouts JIC 37°

93



Z74142

Z74140

Metric Fittings ▪ Conexiones Métricas ▪ Metr. Armaturen ▪ Embouts métriques

93



Z74804

Z74203

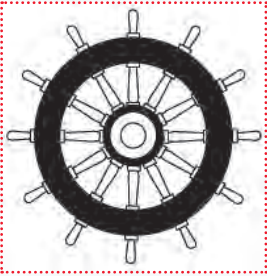

Mangueras/Hoses:

TrAle®

Mangueras/Hoses:

SEMPERIT



**CONEXIONES FABRICADAS POR
FITTINGS MANUFACTURED BY**

DICSA

ISO 9001

BUREAU VERITAS
Certification



INDUSTRY & FACILITIES

ACIE

AGENCIA DE CERTIFICACIÓN
EN INNOVACIÓN ESPAÑOLA

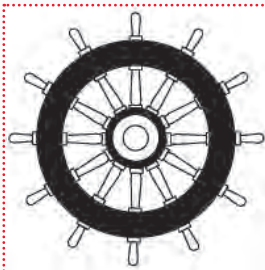

STANDARD SERIES

Conexiones Standard
Standardserie
Embouts série standard

Ferrules R1AT/R2AT/1SN/2SN/R16/2SC/3TE

Casquillos R1AT/R2AT/ 1SN/2SN/ R16/2SC/3TE

Pressfassungen R1AT/R2AT/1SN/2SN/
R16/2SC/3TE

Jupes R1AT/R2AT/1SN/2SN/R16/2SC/3TE



DN	Referencia Part n°	€
3/16"-R1AT	810200300	12,42
3/16"-R2AT	810300300	11,85
1/4"	ZPF221200400	8,44
5/16"	ZPF221200500	9,47
3/8"	ZPF221200600	10,67
1/2"	ZPF221200800	12,78
5/8"	ZPF221201000	15,71
3/4"	ZPF221201200	21,74
1"	ZPF221201600	34,07
1"1/4	ZPF221202000	61,25
1"1/2	ZPF221202400	74,82
2"	ZPF221203200	112,48
2"1/2	NEW ZPF221204000	171,59
3"	NEW ZPF221204800	282,17

Ferrules R1A-1ST

Casquillos R1A-1ST

Pressfassungen R1A-1ST

Jupes R1A-1ST



DN	Referencia Part n°	€
3/16"	820030300	10,37
1/4"	820030400	9,61
5/16"	820030500	10,02
3/8"	820030600	12,03
1/2"	820030800	13,85
5/8"	820031000	18,48
3/4"	820031200	23,63
1"	820031600	31,22
1"1/4	820032000	53,42
1"1/2	820032400	78,60
2"	820033200	113,22

Ferrules R4

Casquillos R4

Pressfassungen R4

Jupes R4



DN	Referencia Part n°	€
3/4"	ZPF221201200R4	27,56

For other sizes, please check out the crimping table on our website./ Para otras medidas, consultar tablas de prensado en nuestra web. / Für andere DN Größe, überprüfen Sie bitte die Pressmaßtabelle auf unserer Webseite. / Pour les autres dimensions, voir tableau de sertissage disponible sur notre site web.

Ferrules 1SC/1SN/2SC/R6/2TE/R17

Casquillos 1SC/1SN/2SC/R6/2TE/R17

Pressfassungen 1SC/1SN/2SC/R6/2TE/R17

Jupes 1SC/1SN/2SC/R6/2TE/R17



DN	Referencia Part n°	€
1/4"	ZSC21120400	9,77
5/16"	ZSC21120500	12,37
3/8"	ZSC21120600	11,87
1/2"	ZSC21120800	13,48
5/8"	ZSC21121000	18,39
3/4"	ZSC21121200	24,80
1"	ZSC21121600	38,89

Ferrules R2A-2ST/4SP-R9R / R12

Casquillos R2A-2ST/4SP-R9R / R12

Pressfassungen R2A-2ST/4SP-R9R / R12

Jupes R2A-2ST/4SP-R9R / R12



DN	Referencia Part n°	€
3/16" - R2A	820060300	9,53
1/4"	ZPF122400400	9,89
5/16"	ZPF122400500	10,55
3/8"	ZPF122400600	11,14
1/2"	ZPF122400800	13,11
5/8"	ZPF122401000	19,20
3/4"	ZPF122401200	20,91
1"	ZPF122401600	34,50
1"1/4	ZPF122402000	59,52
1"1/2	ZPF122402400	78,93
2"	ZPF122403200	118,35

Ferrules 3SP/4SP/R12/4SH non skive

Casquillos 3SP/4SP/R12/4SH no pelar

Pressfassungen 3SP/4SP/R12/4SH ohne Schälung

Jupes 3SP/4SP/R12/4SH sans dénudage



DN	Referencia Part n°	€
3/8"	ZPF222400600	10,84
1/2"	ZPF222400800	13,69
5/8"	ZPF222401000	25,13
3/4"	ZPF222401200	22,46
1"	ZPF222401600	35,03
1" 1/4	ZPF222402000	65,75
1" 1/2	NEW ZPF222402400	94,12
2"	NEW ZPF222403200	133,77

STANDARD SERIES

Conexiones Standard
Standardserie
Embouts série standard

Ferrules R7/R8 and metallic braid / R6

Casquillos R7/R8 y elastómero malla metálica / R6

Pressfassungen R7/R8 und Elastomer/Metallumfl. / R6

Jupes R7/R8 et tresse métallique / R6



DN	Referencia Part n°	€
1/8"	810140200	8,12
3/16"	810140300	8,09
1/4"	810140400	8,00
5/16"	810140500	8,35
3/8"	810140600	9,32
1/2"	810140800	11,51
5/8"	810141000	18,97
3/4"	810141200	16,41
1"	810141600	28,64

Ferrules for Ecology hose and Sewer Jetting hose

Casquillos para mangueras Ecology y limpieza de alcantarillas

Pressf. für Schlauchtyp ECOLOGY und Abflussreinigung

Jupes pour tuyau Ecology et tuyau Hydrocurage



DN	Referencia Part n°	€
3/4"	Z212001200	34,69
1"	Z212001600	51,62
1"1/4	Z212002000	71,84

Ferrules for smooth PTFE

Casquillos PTFE Liso

Pressfassungen für PTFE-Glattschläuche

Jupes PTFE lisse



DN	Referencia Part n°	€
1/8"	810400100	8,37
3/16"	810400300	7,91
1/4"	810400400	6,79
5/16"	810400500	8,63
3/8"	810400600	7,16
1/2"	810400800	9,22
5/8"	810401000	12,62
3/4"	810401200	14,14
1"	810401600	22,72

Ferrules for convoluted PTFE

Casquillos PTFE Corrugado

Pressfassungen für PTFE-Wellschläuche mit Umfl.

Jupes PTFE convoluté



DN	Referencia Part n°	€
1/4"	810410400	7,99
5/16"	810410500	9,10
3/8"	810410600	9,05
1/2"	810410800	9,98
5/8"	810411000	15,76
3/4"	810411201	17,82
1"	810411600	26,45
1"1/4	810412000	41,18
1"1/2	810412400	53,09
2"	810413200	88,78
2"1/2	810414000	118,16

Ferrules for double braid smooth PTFE

Casquillos PTFE Liso doble malla

Pressfassungen für PTFE-Glattschläuche Doppelgeflecht

Jupes PTFE lisse double tresse



DN	Referencia Part n°	€
1/4"	810450400	8,79
3/8"	810450600	12,90

For other sizes, please check out the crimping table on our website. / Para otros tamaños, consultar tabla de prensado en nuestra web. / Für andere DN Größe, überprüfen Sie bitte die Pressmaßtabelle auf unserer Webseite. / Pour les autres dimensions, voir tableau de sertissage disponible sur notre site web.

Ferrules for smooth PTFE, smooth profile



Casquillos PTFE Liso, perfil liso

Pressfassungen für PTFE-Glattschläuche, glattes Profil

Jupes PTFE lisse,profil lisse



DN	Referencia Part n°	€
1/4"	880400400	6,81
5/16"	880400500	8,59
3/8"	880400600	8,07
1/2"	880400800	9,02
5/8"	880401000	17,01

Ferrules for convoluted PTFE, smoth profile



Casquillos PTFE Corrugado, perfil liso

Pressfassungen für PTFE-Wellschläuche, glattes Profil

Jupes PTFE convoluté, profil lisse



DN	Referencia Part n°	€
1/4"	880410400	8,05
5/16"	880410500	7,28
3/8"	880410600	8,28
1/2"	880410800	10,94
5/8"	880411000	14,82
3/4"	880411200	17,41



TrΔle® GOLD + RACOR INOX
STAINLESS STEEL FITTING

COMBINACIÓN PERFECTA PARA OFFSHORE
A PERFECT MATCH FOR OFFSHORE



STANDARD SERIES

Conexiones Standard
Standardserie
Embouts série standard

BSP Swivel female 60° cone

Hembras giratorias rectas rosca BSP cono 60°

Dichtkopf mit BSP Ü-Mutter DKR

Femelle gaz cylindrique BSP 60°



DN	ROSCA THREAD	Referencia Part n°	€
3.2 mm	1/8" BSP	841000201	16,62
1/8"	1/8" BSP	841000202	15,98
3/16"	1/8" BSP	841000203	13,21
1/4"	1/8" BSP	841000204	13,73
3/16"	1/4" BSP	841000403	12,08
1/4"	1/4" BSP	841000404	10,18
5/16"	1/4" BSP	841000405	12,59
3/8"	1/4" BSP	841000406	15,24
1/4"	3/8" BSP	841000604	14,34
5/16"	3/8" BSP	841000605	13,84
3/8"	3/8" BSP	841000606	12,26
1/2"	3/8" BSP	841000608	14,88
3/8"	1/2" BSP	841000806	16,39
1/2"	1/2" BSP	841000808	15,11
5/8"	1/2" BSP	841000810	25,52
1/2"	5/8" BSP	841001008	26,76
5/8"	5/8" BSP	841001010	30,67
1/2"	3/4" BSP	841001208	27,92
5/8"	3/4" BSP	841001210	25,17
3/4"	3/4" BSP	841001212	24,54
3/4"	1" BSP	841001612	40,66
1"	1" BSP	841001616	39,23
1"	1"1/4 BSP	841002016	74,14
1"1/4"	1"1/4 BSP	841002020	76,32
1"1/4"	1"1/2 BSP	841002420	103,64
1"1/2"	1"1/2 BSP	841002424	90,99
1"1/2"	2" BSP	841003224	179,20
2"	2" BSP	841003232	165,72
2"	2"1/2 BSP	NEW 841004032	306,49
2"1/2"	2"1/2 BSP	NEW 841004040	323,85
3"	3" BSP	NEW 841004848	327,76

BSP Swivel female 60° cone with o-ring

Hembras giratorias rectas rosca BSP cono 60° con junta tórica

Dichtkopf mit BSP Ü-Mutter DKR mit O-Ring

Femelle gaz cylindrique BSP 60° avec o-ring



DN	ROSCA THREAD	Referencia Part n°	€
1/4"	1/4" BSP	841100404	14,62
3/8"	3/8" BSP	841100606	14,76
3/8"	1/2" BSP	841100806	23,70
1/2"	1/2" BSP	841100808	17,56
1/2"	3/4" BSP	841101208	32,73
5/8"	1/2" BSP	NEW 841100810	30,57
5/8"	3/4" BSP	841101210	32,83
3/4"	3/4" BSP	841101212	24,88
1"	1" BSP	841101616	46,08
1"1/4"	1"1/4 BSP	841102020	77,74
1"1/2"	1"1/2 BSP	841102424	106,33
2"	2" BSP	841103232	202,06

BSP Swivel female flat seat

Hembras giratorias rectas rosca BSP asiento plano

Dichtkopf mit BSP Ü-Mutter flachdichtend DKR-FLD

Femelle fond plat BSP



DN	ROSCA THREAD	Referencia Part n°	€
1/4"	1/4" BSP	842000404	11,98
1/4"	3/8" BSP	842000604	20,74
5/16"	3/8" BSP	842000605	19,62
3/8"	3/8" BSP	842000606	13,70
1/2"	3/8" BSP	842000608	21,89
1/4"	1/2" BSP	842000804	33,68
3/8"	1/2" BSP	842000806	20,71
1/2"	1/2" BSP	842000808	16,72
1/2"	3/4" BSP	842001208	31,31
5/8"	3/4" BSP	842001210	29,95
3/4"	3/4" BSP	842001212	25,21
5/8"	1" BSP	NEW 842001610	50,38
3/4"	1" BSP	842001612	42,60
1"	1" BSP	842001616	42,37
1"	1"1/4 BSP	842002016	78,97
1"1/4"	1"1/4 BSP	842002020	79,31
1"1/2"	1"1/2 BSP	842002424	97,80
2"	2" BSP	842003232	182,29

Double hexagonal BSP Swivel female cone 60°

Hembras giratorias recta rosca BSP cono 60° doble hexagonal

Dichtkopf mit BSP Ü-Mutter DKR doppelt 6 kt

Femelle BSP cone 60° double hexagonal



DN	ROSCA THREAD	Referencia Part n°	€
1/4"	1/4" BSP	844000404	21,74
5/16"	3/8" BSP	844000605	25,76
3/8"	3/8" BSP	844000606	22,37
1/2"	1/2" BSP	844000808	24,88
3/4"	3/4" BSP	844001212	40,53
1"	1" BSP	844001616	64,48
1"1/4"	1"1/4 BSP	844002020	86,77
1"1/2"	1"1/2 BSP	844002424	135,67
2"	2" BSP	844003232	236,01

STANDARD SERIES

Conexiones Standard
Standardserie
Embouts série standard

BSP Swivel female 60° cone (90° Elbow)

Hembras giratorias 90° rosca BSP cono 60°

Dichtkopf mit BSP Ü-Mutter 60° DKR 90°

Coude 90° femelle gaz cyl. BSP 60°



DN	ROSCA THREAD	Referencia Part n°	€
3/16"	1/8" BSP	841070203*	35,71
1/4"	1/8" BSP	841070204	28,01
3/16"	1/4" BSP	841070403	25,02
1/4"	1/4" BSP	841070404	19,69
5/16"	1/4" BSP	841070405*	40,42
1/4"	3/8" BSP	841070604	28,11
5/16"	3/8" BSP	841070605	28,66
3/8"	1/4" BSP	841070406	27,52
3/8"	3/8" BSP	841070606	22,69
1/4"	1/2" BSP	841070804	43,70
3/8"	1/2" BSP	841070806	37,33
1/2"	1/2" BSP	841070808	28,26
5/8"	5/8" BSP	841071010	50,56
1/2"	3/4" BSP	841071208	50,53
5/8"	3/4" BSP	841071210	55,29
3/4"	3/4" BSP	841071212	47,14
3/4"	1" BSP	841071612	70,11
1"	1" BSP	841071616	70,95
1"	1" 1/4 BSP	841072016	155,05
1" 1/4"	1" 1/4 BSP	841072020	141,58
1" 1/2"	1" 1/2 BSP	841072424	191,53
2"	2" BSP	841073232	361,81

*Welded piece / *Pieza soldada / *Geschweißte stück / *Pièce soudée

BSP Swivel female flat seat (90° Elbow)

Hembras giratorias 90° rosca BSP asiento plano

Dichtkopf mit BSP Ü-Mutter 90° Bogen flachdichtend DKR-FLD

Coude 90° femelle fond plat BSP



DN	ROSCA THREAD	Referencia Part n°	€
1/4"	1/4" BSP	842070404	26,85
5/16"	3/8" BSP	842070605	32,42
3/8"	3/8" BSP	842070606	29,83
1/2"	1/2" BSP	842070808	35,71
3/4"	3/4" BSP	842071212	51,38
3/4"	1" BSP	842071612	83,73
1"	1" BSP	842071616	80,13
1" 1/4"	1" 1/4 BSP	842072020	158,63
1" 1/2"	1" 1/2 BSP	842072424	204,83
2"	2" BSP	842073232	453,47

BSP Swivel female 60° cone (45° Elbow)

Hembras giratorias 45° rosca BSP cono 60°

Dichtkopf mit BSP Ü-Mutter 60° DKR kon. 45°

Coude 45° femelle gaz cyl. BSP 60°



DN	ROSCA THREAD	Referencia Part n°	€
3/16"	1/4" BSP	841080403	25,02
1/4"	1/4" BSP	841080404	19,69
1/4"	3/8" BSP	841080604	28,11
5/16"	3/8" BSP	841080605	28,66
3/8"	3/8" BSP	841080606	22,69
1/4"	1/2" BSP	841080804	43,70
3/8"	1/2" BSP	841080806	37,33
1/2"	1/2" BSP	841080808	28,26
5/8"	5/8" BSP	841081010	50,56
1/2"	3/4" BSP	841081208	50,53
5/8"	3/4" BSP	841081210	55,29
3/4"	3/4" BSP	841081212	47,14
3/4"	1" BSP	841081612	70,11
1"	1" BSP	841081616	70,95
1"	1" 1/4 BSP	841082016	155,05
1" 1/4"	1" 1/4 BSP	841082020	141,58
1" 1/2"	1" 1/2 BSP	841082424	191,53
2"	2" BSP	841083232	361,81

BSP Swivel female flat seat (45° Elbow)

Hembras giratorias 45° rosca BSP asiento plano

Dichtkopf mit BSP Ü-Mutter 45° flachdichtend DKR-FLD

Coude 45° femelle fond plat BSP



DN	ROSCA THREAD	Referencia Part n°	€
1/4"	1/4" BSP	842080404	26,85
5/16"	3/8" BSP	842080605	32,42
3/8"	3/8" BSP	842080606	29,83
3/8"	1/2" BSP	842080806	40,18
1/2"	1/2" BSP	842080808	35,71
3/4"	3/4" BSP	842081212	51,38
3/4"	1" BSP	842081612	83,73
1"	1" BSP	842081616	80,13
1" 1/4"	1" 1/4 BSP	842082020	158,63
1" 1/2"	1" 1/2 BSP	842082424	204,83
2"	2" BSP	842083232	453,47

BSP swivel female 60° (90° Compact Elbow)

Hembras giratorias 90° compactas rosca BSP cono 60°

Dichtkopf BSP 60° kon. DKR einteilig 90°

Coude femelle 90° compact BSP cone 60°



DN	ROSCA THREAD	Referencia Part n°	€
1/4"	1/4" BSP	841270404	49,48
3/8"	3/8" BSP	841270606	51,72
1/2"	1/2" BSP	841270808	80,25
3/4"	3/4" BSP	841271212	100,52
1"	1" BSP	841271616	146,56

STANDARD SERIES

Conexiones Standard
Standardserie
Embouts série standard

BSP Swivel female 60° cone with o-ring (90° Elbow)

Hembras giratorias 90° rosca BSP cono 60° con junta tórica

Dichtkopf mit BSP Ü-Mutter 60° kon. 90° mit Dichtung DKR

Coude 90° femelle gaz cyl. BSP 60° avec o-ring



DN	ROSCA THREAD	Referencia Part n°	€
1/4"	1/4" BSP	841170404	27,88
3/8"	3/8" BSP	841170606	32,66
3/8"	1/2" BSP	841170806	42,76
1/2"	1/2" BSP	841170808	37,14
1/2"	3/4" BSP	841171208	65,22
5/8"	3/4" BSP	841171210	55,43
3/4"	3/4" BSP	841171212	52,92
1"	1" BSP	841171616	84,98
1"1/4	1"1/4 BSP	841172020	160,69
1"1/2	1"1/2 BSP	841172424	221,74
2"	2" BSP	841173232	440,91

BSP Swivel female 60° cone with o-ring (45° Elbow)

Hembras giratorias 45° rosca BSP cono 60° con junta tórica

Dichtkopf mit BSP Ü-Mutter 60° mit O'Ring 45° DKR kon.

Coude 45° femelle gaz cyl. BSP 60° avec o-ring



DN	ROSCA THREAD	Referencia Part n°	€
1/4"	1/4" BSP	841180404	27,88
3/8"	3/8" BSP	841180606	32,66
3/8"	1/2" BSP	841180806	42,76
1/2"	1/2" BSP	841180808	37,14
1/2"	3/4" BSP	841181208	65,22
5/8"	3/4" BSP	841181210	55,43
3/4"	3/4" BSP	841181212	52,92
1"	1" BSP	841181616	84,98
1"1/4	1"1/4 BSP	841182020	160,69
1"1/2	1"1/2 BSP	841182424	221,74
2"	2" BSP	841183232	440,91

O'ring for swivel female BSP FKM green

Juntas para hembra giratoria BSP FKM verde

Dichtungen FKM grün für DKR

Joint torique pour femelle tournante BSP FKM vert



ROSCA THREAD	TAMAÑO SIZE	Referencia Part n°	€
1/4" BSP	6X1	JTVBSP04	0,17
3/8" BSP	8.1X1.6	JTVBSP06	0,18
1/2" BSP	12.1X1.6	JTVBSP08	0,19
5/8" BSP	13.1X1.6	JTVBSP10	0,19
3/4" BSP	17.1X1.6	JTVBSP12	0,23
1" BSP	22.1X1.6	JTVBSP16	0,31
1"1/4 BSP	29.1X1.6	JTVBSP20	0,46
1"1/2 BSP	35.1X1.6	JTVBSP24	0,61
2" BSP	47.35X1.78	JTVBSP32	0,88

STANDARD SERIES

Conexiones Standard
Standardserie
Embouts série standard

BSP Male flat seat

Machos rosca cilíndrica BSP asiento plano

BSP Außengewinde flachdichtend AGR FLACH

Mâle BSP fond plat



DN	ROSCA THREAD	Referencia Part n°	€
3/16"	1/4" BSP	842120403	21,52
1/4"	1/4" BSP	842120404	15,41
5/16"	3/8" BSP	842120605	23,57
3/8"	3/8" BSP	842120606	17,96
1/2"	3/8" BSP	NEW 842120608	25,71
3/8"	1/2" BSP	842120806	27,28
1/2"	1/2" BSP	842120808	20,03
5/8"	5/8" BSP	842121010	39,98
3/4"	3/4" BSP	842121212	28,28
3/4"	1" BSP	842121612	59,65
1"	1" BSP	842121616	55,57
1"	1" 1/4 BSP	842122016	120,02
1" 1/4"	1" 1/4 BSP	842122020	100,84
1" 1/2"	1" 1/2 BSP	842122424	137,08
2"	2" BSP	842123232	169,07

BSP Male-parallel 60° cone

Machos rosca cilíndrica BSP cono 60°

Außengewinde BSP NORM AGR

Mâle BSP cône 60°



DN	ROSCA THREAD	Referencia Part n°	€
3/16"	1/8" BSP	841120203	21,76
1/4"	1/8" BSP	841120204	21,36
3/16"	1/4" BSP	841120403	21,52
1/4"	1/4" BSP	841120404	13,97
5/16"	1/4" BSP	841120405	23,68
3/8"	1/4" BSP	841120406	22,81
1/4"	3/8" BSP	841120604	25,16
5/16"	3/8" BSP	841120605	17,73
3/8"	3/8" BSP	841120606	14,02
1/2"	3/8" BSP	841120608	21,43
3/8"	1/2" BSP	841120806	20,95
1/2"	1/2" BSP	841120808	18,54
5/8"	5/8" BSP	841121010	37,39
5/8"	3/4" BSP	841121210	34,65
3/4"	3/4" BSP	841121212	28,08
3/4"	1" BSP	841121612	55,74
1"	1" BSP	841121616	53,41
1"	1" 1/4 BSP	841122016	93,38
1" 1/4"	1" 1/4 BSP	841122020	90,78
1" 1/4"	1" 1/2 BSP	841122420	118,96
1" 1/2"	1" 1/2 BSP	841122424	111,37
2"	1" 1/2 BSP	NEW 841122432	180,03
2"	2" BSP	841123232	179,53
2" 1/2"	2" 1/2 BSP	NEW 841124040	372,63

Male BSPT tapered

Macho rosca cónica BSPT cono 60°

Außengewinde BSPT Kegelig

Mâle gaz conique BSPT 60°



DN	ROSCA THREAD	Referencia Part n°	€
1/4"	1/4" BSPT	841140404	12,13
5/16"	1/4" BSPT	841140405	20,62
3/8"	1/4" BSPT	841140406	18,72
1/4"	3/8" BSPT	841140604	23,66
5/16"	3/8" BSPT	841140605	20,76
3/8"	3/8" BSPT	841140606	14,67
1/2"	3/8" BSPT	841140608	20,22
3/8"	1/2" BSPT	841140806	26,40
1/2"	1/2" BSPT	841140808	16,39
5/8"	1/2" BSPT	841140810	29,02
3/4"	1/2" BSPT	NEW 841140812	38,41
1/2"	3/4" BSPT	841141208	42,28
5/8"	3/4" BSPT	841141210	31,00
3/4"	3/4" BSPT	841141212	26,08
3/4"	1" BSPT	841141612	44,94
1"	1" BSPT	841141616	44,15
1"	1" 1/4 BSPT	841142016	80,79
1" 1/4"	1" 1/4 BSPT	841142020	81,28
1" 1/4"	1" 1/2 BSPT	841142420	107,19
1" 1/2"	1" 1/2 BSPT	841142424	100,30
2"	2" BSPT	841143232	168,19

CRIMPING FITTINGS FOR HOSES

PIPE FITTINGS

PIPE FITTINGS II

ADAPTORS

WELDING FITTINGS

INDUSTRIAL FITTINGS

ACCESSORIES

CONTROL COMPONENTS

FLOW MEASURING

TRALE LOK

STANDARD SERIES

Conexiones Standard
Standardserie
Embouts série standard

Double hexagonal NPSM Swivel female cone 60°

Hembras giratorias rectas rosca NPSM cono 60°
doble hexagonal
Dichtkopf mit Ü-Muttern NPSM kon. 60° doppelt
6 kt

Femelle NPSM cone 60° double hexagonal



DN	ROSCA THREAD	Referencia Part n°	€
1/4"	1/4" 18h NPSM	843610404	27,33
3/8"	3/8" 18h NPSM	843610606	28,15
1/2"	1/2" 14h NPSM	843610808	31,13
3/4"	3/4" 14h NPSM	843611212	45,39
1"	1" - 11 1/2h NPSM	843611616	72,22

NPSM Swivel female 60° cone

Hembras giratorias rectas rosca NPSM cono 60°

Dichtkopf mit NPSM Ü-Muttern kon. 60°

Femelle NPSM cone 60°



DN	ROSCA THREAD	Referencia Part n°	€
1/4"	1/4" 18h NPSM	842610404	14,38
3/8"	3/8" 18h NPSM	842610606	15,07
1/2"	1/2" 14h NPSM	842610808	20,16
3/4"	3/4" 14h NPSM	842611212	31,37
3/4"	1"-11 1/2h NPSM	842611612	53,10
1"	1"-11 1/2h NPSM	842611616	52,34
1"1/2	1"1/2-11 1/2h NPSM	842612424	101,09

NPSM Swivel female 60° cone (90° Elbow)

Hembras giratorias 90° rosca NPSM cono 60°

Dichtkopf mit NPSM Ü-Mutter 60° kon. 90°

Coude 90° femelle NPSM cone 60°



DN	ROSCA THREAD	Referencia Part n°	€
1/4"	1/4" 18h NPSM	842620404	24,59
3/8"	3/8" 18h NPSM	842620606	26,63
1/2"	1/2" 14h NPSM	842620808	34,50
3/4"	3/4" 14h NPSM	842621212	59,93
1"	1"-11 1/2h NPSM	842621616	82,81

NPSM Swivel female 60° cone (45° Elbow)

Hembras giratorias 45° rosca NPSM cono 60°

Dichtkopf mit NPSM Ü-Mutter 60° kon. 45°

Coude 45° femelle NPSM cone 60°



DN	ROSCA THREAD	Referencia Part n°	€
1/4"	1/4" 18h NPSM	842630404	24,59
3/8"	3/8" 18h NPSM	842630606	26,62
1/2"	1/2" 14h NPSM	842630808	34,50
3/4"	3/4" 14h NPSM	842631212	59,94
1"	1"-11 1/2h NPSM	842631616	82,81

NPT Male pipe straight

Machos rosca cónica NPT

Außengewinde kon. NPT AGN

Embout mâle conique NPT (BRIGGS)



DN	ROSCA THREAD	Referencia Part n°	€
1/4"	1/8" NPT	841610204	19,02
3/16"	1/4" NPT	841610403	17,97
1/4"	1/4" NPT	841610404	12,16
5/16"	1/4" NPT	841610405	20,94
3/8"	1/4" NPT	841610406	21,36
1/4"	3/8" NPT	841610604	20,89
5/16"	3/8" NPT	841610605	23,62
3/8"	3/8" NPT	841610606	12,81
1/2"	3/8" NPT	841610608	25,46
1/4"	1/2" NPT	841610804	34,45
3/8"	1/2" NPT	841610806	27,83
1/2"	1/2" NPT	841610808	18,08
5/8"	1/2" NPT	841610810	25,56
1/2"	3/4" NPT	841611208	37,25
5/8"	3/4" NPT	841611210	33,33
3/4"	3/4" NPT	841611212	27,09
1"	3/4" NPT	NEW 841611216	44,07
3/4"	1" NPT	841611612	50,32
1"	1" NPT	841611616	44,58
1"	1"1/4 NPT	841612016	87,26
1"1/4	1"1/4 NPT	841612020	82,13
1"	1"1/2 NPT	NEW 841612416	119,79
1"1/4	1"1/2 NPT	841612420	98,89
1"1/2	1"1/2 NPT	841612424	95,51
2"	2" NPT	841613232	170,71

Swivel male NPT

Machos giratorios NPT

Außengewinde NPT

Mâle tournant NPT



DN	ROSCA THREAD	Referencia Part n°	€
1/4"	1/4" NPT	841650404	46,47
3/8"	3/8" NPT	841650606	47,32
3/8"	1/2" NPT	NEW 841650806	70,28
1/2"	1/2" NPT	841650808	51,65
3/4"	1/2" NPT	NEW 841650812	85,30
1/2"	3/4" NPT	NEW 841651208	88,23
3/4"	3/4" NPT	841651212	73,85
3/4"	1" NPT	841651612	117,13
1"	1" NPT	841651616	109,39

STANDARD SERIES

Conexiones Standard
Standardserie
Embouts série standard

Double hexagonal JIC 37° Swivel female

Hembras giratorias recta JIC 37° doble hexagonal

Dichtkonus mit Ü-Mutter JIC 37° DKJ doppelt 6 kt

Femelle JIC 37° double hexagonal



DN	ROSCA THREAD	Referencia Part n°	€
3/16"	7/16" 20h UNF	842420703	17,66
1/4"	7/16" 20h UNF	842420704	15,89
5/16"	7/16" 20h UNF	842420705	26,54
3/8"	7/16" 20h UNF	NEW 842420706	31,46
1/4"	1/2" 20h UNF	842420804	21,46
5/16"	1/2" 20h UNF	842420805	27,31
3/8"	1/2" 20h UNF	842420806	24,70
1/4"	9/16" 18h UNF	842420904	24,45
5/16"	9/16" 18h UNF	842420905	26,99
3/8"	9/16" 18h UNF	842420906	17,49
3/8"	3/4" 16h UNF	842421206	23,55
1/2"	3/4" 16h UNF	842421208	19,21
5/8"	3/4" 16h UNF	842421210	27,71
3/4"	3/4" 16h UNF	NEW 842421212	45,82
1/2"	7/8" 14h UNF	842421408	32,36
5/8"	7/8" 14h UNF	842421410	35,16
3/4"	7/8" 14h UNF	842421412	37,97
5/8"	1"1/16 12h UN	842421710	39,52
3/4"	1"1/16 12h UN	842421712	34,40
1"	1"1/16 12h UN	842421716	57,62
3/4"	1"5/16 12h UN	842422112	54,05
1"	1"5/16 12h UN	842422116	52,89
1"1/4"	1"5/8 12h UN	842422620	107,98
1"1/2"	1"7/8 12h UN	842423024	141,27
2"	2"1/2 12h UN	842424032	270,87

JIC 37° Swivel female

Hembras giratorias recta JIC 37°

Dichtkonus mit Ü-Mutter JIC 37°

Femelle droite JIC cone 37°



DN	ROSCA THREAD	Referencia Part n°	€
3.2 mm	7/16" 20h UNF	841420701	17,12
3/16"	7/16" 20h UNF	841420703	13,62
1/4"	7/16" 20h UNF	841420704	11,46
3/16"	1/2" 20h UNF	841420803	15,71
1/4"	1/2" 20h UNF	841420804	12,69
5/16"	1/2" 20h UNF	841420805	14,09
1/4"	9/16" 18h UNF	841420904	14,17
5/16"	9/16" 18h UNF	841420905	13,08
3/8"	9/16" 18h UNF	841420906	13,46
3/8"	3/4" 16h UNF	841421206	16,43
1/2"	3/4" 16h UNF	841421208	16,76
3/8"	7/8" 14h UNF	841421406	22,00
1/2"	7/8" 14h UNF	841421408	18,64
5/8"	7/8" 14h UNF	841421410	22,37
1/2"	1"1/16 12h UN	841421708	37,81
5/8"	1"1/16 12h UN	841421710	30,09
3/4"	1"1/16 12h UN	841421712	24,89
1"	1"1/16 12h UN	841421716	40,34
3/4"	1"5/16 12h UN	841422112	39,02
1"	1"5/16 12h UN	841422116	41,25
1"	1"5/8 12h UN	841422616	71,31
1"1/4"	1"5/8 12h UN	841422620	75,29
1" 1/4"	1"7/8 12h UN	841423020	135,47
1"1/2"	1"7/8 12h UN	841423024	104,81
2"	2"1/2 12h UN	841424032	206,05

JIC 37° Swivel female (90° Elbow)

Hembras giratorias 90° JIC 37°

Dichtkonus JIC 37° DKJ 90°

Coude 90° femelle JIC cone 37°



DN	ROSCA THREAD	Referencia Part n°	€
3/16"	7/16" 20h UNF	841380703	27,75
1/4"	7/16" 20h UNF	841380704	20,80
1/4"	1/2" 20h UNF	841380804	24,44
5/16"	1/2" 20h UNF	841380805	35,36
1/4"	9/16" 18h UNF	841380904	35,51
5/16"	9/16" 18h UNF	841380905	27,14
3/8"	9/16" 18h UNF	841380906	25,89
3/8"	3/4" 16h UNF	841381206	34,94
1/2"	3/4" 16h UNF	841381208	30,91
3/8"	7/8" 14h UNF	841381406	38,37
1/2"	7/8" 14h UNF	841381408	33,61
5/8"	7/8" 14h UNF	841381410	41,68
5/8"	1"1/16 12h UN	841381710	51,82
3/4"	1"1/16 12h UN	841381712	49,41
3/4"	1" 5/16 12h UN	841382112	77,90
1"	1"5/16 12h UN	841382116	75,94
1"	1"5/8 12h UN	841382616	157,54
1"1/4"	1"5/8 12h UN	841382620	132,85
1" 1/4"	1" 7/8 12h UN	841383020	216,64
1"1/2"	1"7/8 12h UN	841383024	223,28
2"	2"1/2 12h UN	841384032	485,67

STANDARD SERIES

Conexiones Standard
Standardserie
Embouts série standard

JIC 37° Swivel female (45° Elbow)

Hembras giratorias 45° JIC 37°

Dichtkonus JIC 37° DKJ 45°

Coude 45° femelle JIC cone 37°



DN	ROSCA THREAD	Referencia Part n°	€
3/16"	7/16" 20h UNF	841390703	27,75
1/4"	7/16" 20h UNF	841390704	20,80
1/4"	1/2" 20h UNF	841390804	24,44
5/16"	1/2" 20h UNF	841390805	35,36
1/4"	9/16" 18h UNF	841390904	35,51
5/16"	9/16" 18h UNF	841390905	27,15
3/8"	9/16" 18h UNF	841390906	25,89
3/8"	3/4" 16h UNF	841391206	34,94
1/2"	3/4" 16h UNF	841391208	30,91
3/8"	7/8" 14h UNF	841391406	38,37
1/2"	7/8" 14h UNF	841391408	33,61
5/8"	7/8" 14h UNF	841391410	41,68
5/8"	1"1/16 12h UN	841391710	51,82
3/4"	1"1/16 12h UN	841391712	49,41
3/4"	1"5/16 12h UN	841392112	77,90
1"	1"5/16 12h UN	841392116	75,94
1"	1"5/8 12h UN	841392616	157,54
1"1/4	1"5/8 12h UN	841392620	132,85
1"1/4	1"7/8 12h UN	841393020	216,64
1"1/2	1"7/8 12h UN	841393024	223,28
2"	2"1/2 12h UN	841394032	485,67

Male JIC 37°

Machos rosca JIC cono 37°

Außengewinde JIC 37° AGJ

Mâle fixe JIC cone 37°



DN	ROSCA THREAD	Referencia Part n°	€
1/4"	7/16" 20h UNF	841400704	17,98
1/4"	1/2" 20h UNF	841400804	18,66
5/16"	1/2" 20h UNF	841400805	17,32
1/4"	9/16" 18h UNF	841400904	23,29
5/16"	9/16" 18h UNF	841400905	23,37
3/8"	9/16" 18h UNF	841400906	22,44
1/4"	3/4" 16h UNF	841401204	34,88
3/8"	3/4" 16h UNF	841401206	17,30
1/2"	3/4" 16h UNF	841401208	22,04
3/8"	7/8" 14h UNF	841401406	26,79
1/2"	7/8" 14h UNF	841401408	19,34
5/8"	7/8" 14h UNF	841401410	27,46
5/8"	1"1/16 12h UN	841401710	35,27
3/4"	1"1/16 12h UN	841401712	32,79
1"	1"1/16 12h UN	841401716	38,58
3/4"	1"5/16 12h UN	841402112	51,35
1"	1"5/16 12h UN	841402116	52,90
1"	1"5/8 12h UN	841402616	85,56
1"1/4	1"5/8 12h UN	841402620	85,20
1"1/2	1"7/8 12h UN	841403024	108,23
2"	2"1/2 12h UN	841404032	251,15

Male JIC 37° with o'ring

Machos rosca JIC cono 37° con junta

Außengewinde JIC 37° AGJ mit Dichtung

Mâle fixe JIC cone 37° avec o'ring



DN	ROSCA THREAD	Referencia Part n°	€
1/4"	7/16" 20h UNF	841410704	19,01
3/8"	9/16" 18h UNF	841410906	22,80
1/2"	3/4" 16h UNF	841411208	26,68
3/4"	1"1/16 12h UN	841411712	49,62
1"	1"5/16 12h UN	841412116	62,64
1"1/4	1"5/8 12h UN	841412620	121,71
1"1/2	1"7/8 12h UN	841413024	155,54
2"	2"1/2 12h UN	841414032	386,15

JIC 37° Swivel female (90° Compact Elbow)

Hembras giratorias 90° compactas JIC 37°

Dichtkonus JIC 37° einteilig 90° DKJ

Coude femelle 90° compact JIC cone 37°



DN	ROSCA THREAD	Referencia Part n°	€
1/4"	7/16" 20h UNF	841370704	55,67
3/8"	9/16" 18h UNF	841370906	57,70
1/2"	3/4" 16h UNF	841371208	64,93
3/4"	1"1/16 12h UNF	841371712	106,56
1"	1"5/16 12h UNF	841372116	145,88

STANDARD SERIES

Conexiones Standard
Standardserie
Embouts série standard

Metric female swivel with o'ring 24° cone

Hembras giratorias rectas rosca Métrica cono 24° con junta tórica - DKO
Dichtkegel mit Ü-Mutter und O-Ring DIN 20078 DKOL/DKOS



Femelle Métrique avec o'ring cône 24°

DN	TUBO PIPE	SERIE SERIES	ROSCA THREAD	Referencia Part n°	€
3/16"	6	L	M12x1.5	84804120603	13,64
1/4"	6	L	M12x1.5	84804120604	11,89
1/4"	8	L	M14x1.5	84804140804	11,00
5/16"	8	L	M14x1.5	84804140805	17,08
3/8"	8	L	M 14x1.5	84804140806	21,77
1/4"	10	L	M16x1.5	84804161004	12,77
5/16"	10	L	M16x1.5	84804161005	12,28
3/8"	10	L	M16x1.5	84804161006	13,72
1/4"	12	L	M18x1.5	84804181204	19,70
5/16"	12	L	M18x1.5	84804181205	15,66
3/8"	12	L	M18x1.5	84804181206	12,87
1/2"	12	L	M 18x1.5	84804181208	29,70
1/4"	15	L	M22x1.5	84804221504	22,22
5/16"	15	L	M22x1.5	84804221505	21,65
3/8"	15	L	M22x1.5	84804221506	18,70
1/2"	15	L	M22x1.5	84804221508	17,95
5/8"	15	L	M22x1,5	84804221510	34,51
3/8"	18	L	M26x1,5	84804261806	30,62
1/2"	18	L	M26x1,5	84804261808	26,99
5/8"	18	L	M26x1,5	84804261810	24,77
3/4"	18	L	M26x1,5	84804261812	40,17
1/2"	22	L	M30x2	84804302208	36,14
5/8"	22	L	M30x2	84804302210	33,47
3/4"	22	L	M30x2	84804302212	30,28
3/4"	28	L	M36x2	84804362812	54,62
1"	28	L	M36x2	84804362816	50,19
1"	35	L	M45x2	84804453516	100,29
1"1/4	35	L	M45x2	84804453520	75,34
1"1/4	42	L	M52x2	84804524220	122,27
1"1/2	42	L	M52x2	84804524224	101,83
2"	42	L	M52x2	84804524232	190,00
1/4"	6	S	M14x1.5	84804140604	17,11
1/4"	8	S	M16x1.5	84804160804	13,83
5/16"	8	S	M16x1.5	84804160805	19,08
3/8"	8	S	M16x1.5	84804160806	18,92
1/4"	10	S	M18x1.5	84804181004	13,59
5/16"	10	S	M18x1.5	84804181005	20,53
3/8"	10	S	M18x1.5	84804181006	24,14
5/16"	12	S	M20x1.5	84804201205	17,66
3/8"	12	S	M20x1.5	84804201206	16,05
1/2"	12	S	M20x1.5	84804201208	22,30
5/16"	14	S	M22x1.5	84804221405	21,29
3/8"	14	S	M22x1.5	84804221406	20,68
1/2"	14	S	M22X1.5	NEW 84804221408	20,43
1/4"	16	S	M24x1.5	84804241604	26,90
5/16"	16	S	M24x1.5	84804241605	26,36
3/8"	16	S	M24x1.5	84804241606	24,41
1/2"	16	S	M24x1.5	84804241608	17,74
5/8"	16	S	M24x1.5	84804241610	31,55
1/2"	20	S	M30x2	84804302008	33,96
5/8"	20	S	M30x2	84804302010	27,83
3/4"	20	S	M30x2	84804302012	41,80
5/8"	25	S	M36x2	84804362510	53,49
3/4"	25	S	M36x2	84804362512	49,23
1"	25	S	M36x2	84804362516	61,75
3/4"	30	S	M42x2	84804423012	71,21
1"	30	S	M42x2	84804423016	70,76
1"1/4	38	S	M52x2	84804523820	108,78

Metric Male stud 24° cone

Machos rosca Métrica cono 24°

Gewindezapfen L/S DIN 20078 D/E CEL/CES



Mâle métrique cône 24°

DN	TUBO PIPE	SERIE SERIES	ROSCA THREAD	Referencia Part n°	€
1/4"	6	L	M12x1.5	84203120604	20,64
1/4"	8	L	M14x1.5	84203140804	14,34
1/4"	10	L	M16x1.5	84203161004	17,10
5/16"	10	L	M16x1.5	84203161005	21,05
3/8"	10	L	M16x1.5	84203161006	19,75
1/4"	12	L	M18x1.5	84203181204	21,25
5/16"	12	L	M18x1.5	84203181205	19,48
3/8"	12	L	M18x1.5	84203181206	11,73
3/8"	15	L	M22x1.5	84203221506	22,63
1/2"	15	L	M22x1.5	84203221508	17,98
1/2"	18	L	M26x1.5	84203261808	28,61
5/8"	18	L	M26x1.5	84203261810	26,93
3/4"	22	L	M30x2	84203302212	35,22
1"	28	L	M36x2	84203362816	51,53
1"1/4	35	L	M45x2	84203453520	79,13
1"1/2	42	L	M52x2	84203524224	126,61
1/4"	6	S	M14x1.5	84203140604	20,81
1/4"	8	S	M16x1.5	84203160804	19,97
1/4"	10	S	M18x1.5	84203181004	24,42
5/16"	10	S	M18x1.5	84203181005	30,60
3/8"	10	S	M18x1.5	84203181006	21,50
5/16"	12	S	M20x1.5	84203201205	23,69
3/8"	12	S	M20x1.5	84203201206	22,49
3/8"	14	S	M22x1.5	84203221406	27,31
1/2"	14	S	M22x1.5	84203221408	32,21
1/2"	16	S	M24x1.5	84203241608	20,98
5/8"	20	S	M30x2	84203302010	37,45
3/4"	20	S	M30x2	84203302012	38,90
3/4"	25	S	M36x2	84203362512	54,85
1"	25	S	M36x2	84203362516	69,88
1"	30	S	M42x2	84203423016	84,35
1"1/4	38	S	M52x2	84203523820	125,34

Metric female swivel 24° /60° cone

Hembras giratorias rectas rosca Métrica cono 24° /60°

Dichtkegel mit Ü-Mutter metr. kon. 24° /60° DKM



Femelle Métrique cône 24° /60°

DN	TUBO PIPE	SERIE SERIES	ROSCA THREAD	Referencia Part n°	€
1/4"	8	L	M14x1.5	84404140804	14,13
1/4"	10	L	M16x1.5	84404161004	17,88
5/16"	10	L	M16x1.5	84404161005	18,35
3/8"	10	L	M16x1.5	84404161006	18,28
5/16"	12	L	M18x1.5	84404181205	21,92
3/8"	12	L	M18x1.5	84404181206	17,21
3/8"	15	L	M22x1.5	84404221506	26,18
1/2"	15	L	M22x1.5	84404221508	25,90
5/8"	18	L	M26x1.5	84404261810	34,68

STANDARD SERIES

Conexiones Standard
Standardserie
Embouts série standard

Metric swivel female with o'ring 24° cone (90° Elbow)

Hembras giratorias 90° Métricas cono 24° con junta tórica - DKO 90°
Dichtkegel mit Ü-Mutter und O-Ring DIN 20078 90°
Bogen DKOL 90° /DKOS 90°



Coude 90° femelle Métrique cône 24° avec o'ring

DN	TUBO PIPE	ROSCA THREAD	SERIE SERIES	Referencia Part n°	€
3/16"	6	M12x1.5	L	84305120603	27,47
1/4"	6	M12x1.5	L	84305120604	22,39
1/4"	8	M14x1.5	L	84305140804	21,31
5/16"	8	M14x1.5	L	84305140805	31,92
1/4"	10	M16x1.5	L	84305161004	24,98
5/16"	10	M16x1.5	L	84305161005	28,81
3/8"	10	M16x1.5	L	84305161006	27,47
1/4"	12	M18x1.5	L	84305181204	34,22
5/16"	12	M18x1.5	L	84305181205	33,31
3/8"	12	M18x1.5	L	84305181206	25,42
1/2"	12	M18x1.5	L	84305181208	39,04
1/2"	15	M22x1.5	L	84305221508	32,04
5/8"	15	M22x1.5	L	84305221510	68,58
1/2"	18	M26x1.5	L	84305261808	48,97
5/8"	18	M26x1.5	L	84305261810	46,01
5/8"	22	M30x2	L	84305302210	58,10
3/4"	22	M30x2	L	84305302212	54,91
3/4"	28	M36x2	L	84305362812	87,20
1"	28	M36x2	L	84305362816	85,92
1" 1/4	35	M45x2	L	84305453520	152,12
1" 1/2	42	M52x2	L	84305524224	225,65
1/4"	6	M14x1.5	S	84305140604	31,06
1/4"	8	M16x1.5	S	84305160804	25,89
5/16"	8	M16x1.5	S	84305160805	28,48
1/4"	10	M18x1.5	S	84305181004	26,29
1/4"	12	M20x1.5	S	84305201204	35,18
5/16"	10	M18x1.5	S	84305181005	38,79
3/8"	10	M18x1.5	S	84305181006	35,71
5/16"	12	M20x1.5	S	84305201205	37,09
3/8"	12	M20x1.5	S	84305201206	30,59
1/2"	12	M20x1.5	S	84305201208	33,35
3/8"	14	M22x1.5	S	84305221406	41,87
1/2"	14	M22x1.5	S	84305221408	39,35
3/8"	16	M24x1.5	S	84305241606	36,70
1/2"	16	M24x1.5	S	84305241608	34,83
3/8"	20	M30x2	S	84305302006	70,66
5/8"	20	M30x2	S	84305302010	55,69
3/4"	20	M30x2	S	84305302012	58,23
3/4"	25	M36x2	S	84305362512	78,36
1"	25	M36x2	S	84305362516	96,68
5/8"	30	M42x2	S	84305423010	119,64
3/4"	30	M42x2	S	84305423012	168,98
1"	30	M42x2	S	84305423016	121,49
1" 1/4	38	M52x2	S	84305523820	203,91

Metric swivel female with o'ring 24° cone (45° Elbow)

Hembras giratorias 45° Métricas cono 24° con junta tórica - DKO 45°
Dichtkegel mit Ü-Mutter und O-Ring DIN 20078 45°
Bogen DKOL 45° /DKOS 45° kon.



Coude 45° femelle Métrique cône 24° avec o'ring

DN	TUBO PIPE	SERIE SERIES	ROSCA THREAD	Referencia Part n°	€
3/16"	6	L	M12x1.5	84306120603	27,48
1/4"	6	L	M12x1.5	84306120604	22,39
1/4"	8	L	M14x1.5	84306140804	21,31
5/16"	8	L	M14x1.5	84306140805	31,92
1/4"	10	L	M16x1.5	84306161004	24,98
5/16"	10	L	M16x1.5	84306161005	28,81
3/8"	10	L	M16x1.5	84306161006	27,47
1/4"	12	L	M18x1.5	84306181204	34,22
5/16"	12	L	M18x1.5	84306181205	33,31
3/8"	12	L	M18x1.5	84306181206	25,64
1/2"	12	L	M18x1.5	84306181208	39,04
3/8"	15	L	M22x1.5	84306221506	42,28
1/2"	15	L	M22x1.5	84306221508	32,04
1/2"	18	L	M26x1.5	84306261808	48,97
5/8"	18	L	M26x1.5	84306261810	46,01
5/8"	22	L	M30x2	84306302210	58,10
3/4"	22	L	M30x2	84306302212	54,91
3/4"	28	L	M36x2	84306362812	87,20
1"	28	L	M36x2	84306362816	85,92
1" 1/4	35	L	M45x2	84306453520	152,12
1" 1/2	42	L	M52x2	84306524224	225,65
1/4"	6	S	M14x1.5	84306140604	31,06
1/4"	8	S	M16x1.5	84306160804	25,89
5/16"	8	S	M16x1.5	84306160805	28,48
1/4"	10	S	M18x1.5	84306181004	26,29
3/8"	10	S	M18x1.5	84306181006	35,71
1/4"	12	S	M20x1.5	84306201204	35,18
5/16"	12	S	M20x1.5	84306201205	37,09
3/8"	12	S	M20x1.5	84306201206	27,98
1/2"	12	S	M20x1.5	84306201208	33,35
3/8"	14	S	M22x1.5	84306221406	41,87
3/8"	16	S	M24x1.5	84306241606	36,70
1/2"	16	S	M24x1.5	84306241608	31,66
3/8"	20	S	M30x2	84306302006	70,66
5/8"	20	S	M30x2	84306302010	55,69
3/4"	20	S	M30x2	84306302012	58,23
3/4"	25	S	M36x2	84306362512	78,36
1"	25	S	M36x2	84306362516	96,68
3/4"	30	S	M42x2	84306423012	168,98
1"	30	S	M42x2	84306423016	121,49
1" 1/4	38	S	M52x2	84306523820	203,91

STANDARD SERIES

Conexiones Standard
Standardserie
Embouts série standard

Metric female swivel without o'ring 24° cone

NEW

Hembras giratorias rectas rosca Métrica 24° sin junta tórica

Dichtkegel mit U-Mutter ohne O-Ring DIN 20078 DKL/DKS

Femelle Métrique cône 24° sans o'ring



TUBO PIPE	SERIE SERIES	ROSCA THREAD	DN DN	Referencia Part n°	€
8	L	M14x1.5	1/4"	84814140804	10,41
10	L	M16x1.5	5/16"	84814161005	19,98
12	L	M18x1.5	3/8"	84814181206	17,90
15	L	M22x1.5	1/2"	84814221508	18,49
18	L	M26x1.5	5/8"	84814261810	25,51
22	L	M30x2	3/4"	84814302212	31,19

Metric swivel female without o'ring 24° cone (45° Elbow)

NEW

Hembras giratorias 45° Métricas 24° sin junta tórica

Dichtkegel mit Ü-Mutter ohne O-Ring DIN 20078 45° Bogen DKL 45°/DKS 45° kon.

Coude 45° femelle Métrique cône 24° sans o'ring



DN	TUBO PIPE	SERIE SERIES	ROSCA THREAD	Referencia Part n°	€
1/4"	8	L	M14x1.5	84316140804	21,94
5/16"	10	L	M16x1.5	84316161005	29,67
3/8"	12	L	M18x1.5	84316181206	26,18
1/2"	15	L	M22x1.5	84316221508	31,79
5/8"	18	L	M26x1.5	84316261810	47,39
3/4"	22	L	M30x2	84316302212	56,56

Metric swivel female without o'ring 24° cone (90° Elbow)

NEW

Hembras giratorias 90° Métricas 24° sin junta tórica

Dichtkegel mit Ü-Mutter ohne O-Ring DIN 20078 90° Bogen DKL 90°/DKS 90°

Coude 90° femelle Métrique cône 24° sans o'ring



DN	TUBO PIPE	SERIE Serie	ROSCA THREAD	Referencia Part n°	€
1/4"	8	L	M14x1.5	84315140804	21,94
5/16"	10	L	M16x1.5	84315161005	29,67
3/8"	12	L	M18x1.5	84315181206	26,18
1/2"	15	L	M22x1.5	84315221508	31,79
5/8"	18	L	M26x1.5	84315261810	47,39
3/4"	22	L	M30x2	84315302212	56,56

- Sin junta tórica
- Especial mangueras PTFE
- Altas temperaturas
- Resistencia química

- Without o'ring
- PTFE Hose
- High temperature
- Chemist resistance



STANDARD SERIES

Conexiones Standard
Standardserie
Embouts série standard

Metric standpipe for DIN 2353 fittings

Espigas lisas rectas Métricas

Metr. Stutzen BEL / BES gerade

Embout lisse droit Métrique



DN	TUBO PIPE	Referencia Part n°	€
3.2 mm	6	841580601	10,29
1/8"	6	841580602	10,49
3/16"	6	841580603	9,80
1/4"	6	841580604	9,42
3/16"	8	841580803	9,34
1/4"	8	841580804	8,78
5/16"	8	841580805	10,92
3/8"	8	841580806	10,98
1/4"	10	841581004	9,32
5/16"	10	841581005	10,48
3/8"	10	841581006	9,46
1/4"	12	841581204	12,46
5/16"	12	841581205	12,37
3/8"	12	841581206	8,59
1/2"	12	841581208	12,16
3/8"	14	841581406	11,79
1/2"	14	841581408	17,24
3/8"	15	841581506	16,45
1/2"	15	841581508	12,98
1/2"	16	841581608	14,51
1/2"	18	841581808	19,44
5/8"	18	841581810	19,34
3/4"	18	841581812	27,45
1/2"	20	841582008	21,68
5/8"	20	841582010	22,12
3/4"	20	841582012	24,05
5/8"	22	841582210	22,92
3/4"	22	841582212	25,40
3/4"	25	841582512	29,59
1"	25	841582516	32,12
1"	28	841582816	30,60
1"	30	841583016	33,46
1"1/4	35	841583520	48,30
1"1/4	38	841583820	58,29
1"1/2	38	841583824	66,57
1"1/2	42	841584224	61,49

Fractional Straight standpipe

Espigas lisas rectas para tubo en pulgadas

Zölliger Stutzen gerade glatt

Embout lisse tube pouce



DN	TUBO PIPE	Referencia Part n°	€
1/4"	6.4	841590604	11,60
3/8"	9.5	841590906	14,31
3/8"	12.7	841591206	16,12
1/2"	12.7	841591208	15,37
5/8"	12.7	NEW 841591210	22,31
1/2"	15.8	NEW 841591508	17,92
5/8"	15.8	841591510	22,30
5/8"	19.05	NEW 841591910	32,14
3/4"	19.05	841591912	29,48
1"	25.4	NEW 841592516	33,94

Metric standpipe DIN 2353 fittings (90° Elbow)

Espigas lisas 90° Métricas

Metr. Stutzen BEL/BES 90°

Embout lisse coude 90° Métrique



DN	TUBO PIPE	Referencia Part n°	€
1/8"	6	842580602	31,37
3/16"	6	842580603	26,99
1/4"	6	842580604	20,61
3/16"	8	842580803	25,65
1/4"	8	842580804	19,41
5/16"	8	842580805	22,53
1/4"	10	842581004	20,54
5/16"	10	842581005	24,08
3/8"	10	842581006	27,89
1/4"	12	842581204	25,48
5/16"	12	842581205	27,06
3/8"	12	842581206	21,11
1/2"	12	842581208	34,13
3/8"	14	842581406	29,94
1/2"	14	842581408	40,10
3/8"	15	842581506	36,30
1/2"	15	842581508	31,86
1/2"	16	842581608	38,07
1/2"	18	842581808	39,39
5/8"	18	842581810	42,21
5/8"	20	842582010	52,90
3/4"	20	842582012	57,13
5/8"	22	842582210	65,07
3/4"	22	842582212	49,15
3/4"	25	842582512	52,19
1"	28	842582816	80,16
1"	30	842583016	79,08

Fractional standpipe (90° Elbow)

Espigas lisas 90° para tubo en pulgadas

Zölliger Stutzen glatt 90°

Embout lisse coude 90° tube pouce



DN	TUBO PIPE	Referencia Part n°	€
1/4"	6.4	842590604	32,48
3/8"	9.5	842590906	34,72
1/2"	12.7	842591208	43,29

STANDARD SERIES

Conexiones Standard
Standardserie
Embouts série standard

Metric standpipe DIN 2353 fittings (45° Elbow)

Espigas lisas 45° Métricas

Metr. Stutzen BEL/BES 45°

Embout lisse coude 45° Métrique



DN	TUBO PIPE	Referencia Part n°	€
1/8"	6	843580602	31,37
3/16"	6	843580603	26,99
1/4"	6	843580604	20,61
3/16"	8	843580803	25,65
1/4"	8	843580804	19,40
5/16"	8	843580805*	22,53
1/4"	10	843581004	20,54
5/16"	10	843581005	24,08
3/8"	10	843581006	27,89
1/4"	12	843581204	25,48
5/16"	12	843581205	27,06
3/8"	12	843581206	21,11
1/2"	12	843581208	34,13
3/8"	14	843581406	29,88
1/2"	14	843581408	40,10
3/8"	15	843581506	36,30
1/2"	15	843581508	31,86
1/2"	16	843581608	38,07
1/2"	18	843581808	39,37
5/8"	18	843581810	42,21
5/8"	20	843582010	52,90
1/2"	20	843582012	57,13
5/8"	22	843582210	65,07
3/4"	22	843582212	49,15
3/4"	25	843582512	52,19
1"	28	843582816	80,16
1"	30	843583016	79,08

*Until end of stock / Hasta fin de existencias / Bis zum Ende des Lagerbestandes / Jusqu'à la fin du stock

Fractional Standpipe for inch tube (45° Elbow)

Espigas lisas 45° para tubo en pulgadas

Zölliger Stutzen glatt 45°

Embout lisse coude 45° tube pouce



DN	TUBO PIPE	Referencia Part n°	€
1/4"	6,4	843590604	32,48
3/8"	9,5	843590906	34,72
1/2"	12,7	843591208	43,29

Double crimp standpipe

Espigas de prensar dobles

Doppelnippel

Embout double jonction



DN	Referencia Part n°	€
1/4"	843000404	25,33
5/16"	843000505	26,46
3/8"	843000606	25,12
1/2"	843000808	31,29
3/4"	843001212	58,17
1"	843001616	61,24
1"1/4	843002020	124,07
1"1/2	843002424	140,05
2"	843003232	296,65

Welding standpipes

Espigas soldables

Schweißstutzen

Embout lisse à souder



DN	Referencia Part n°	€
1/8"	840000200*	14,01
3/16"	840000300	18,43
1/4"	840000400	11,51
5/16"	840000500	16,21
3/8"	840000600	19,26
1/2"	840000800	16,97
5/8"	840001000	22,96
3/4"	840001200	23,85
1"	840001600	25,33
1"1/4	840002000	55,44
1"1/2	840002400	63,90
2"	840003200	98,91
2"1/2	840004000	186,35

*Until end of stock / Hasta fin de existencias / Bis zum Ende des Lagerbestandes / Jusqu'à la fin du stock

STANDARD SERIES

Conexiones Standard
Standardserie
Embouts série standard

Banjo BSP

Orientables BSP

Ringaugen BSP RN-BSP

Banjo droit gaz BSP



DN	Ø	Referencia Part n°	€
1/4"	1/4"	841110404	34,10
1/4"	3/8"	841110604	48,66
5/16"	3/8"	841110605	44,96
3/8"	3/8"	841110606	38,76
1/2"	3/8"	841110608	61,46
3/8"	1/2"	841110806	66,95
1/2"	1/2"	841110808	59,34
3/4"	3/4"	841111212	91,59
1"	1"	841111616	203,82

BSP Bolt for banjo

Tornillo orientable simple BSP

Einfache Hohlschraube BSP für Ringauge

Vis creuse simple pour banjo gaz



ROSCA THREAD	Referencia Part n°	€
1/8" BSP	Z109002	*
1/4" BSP	Z109004	*
3/8" BSP	Z109006	*
1/2" BSP	Z109008	*
3/4" BSP	Z109012	*
1" BSP	Z109016	*

*See prices in p.180 (BSP ADAPTORS) / *Ver precios en p.180 (ADAPTADORES BSP) / *Vgl. Sie die Preise auf S. 180 (BSP-Adapter) / *Prix à la p.180 (ADAPTEURS BSP)

Standpipes for hidrowashing machines

Espigas para Hidrolavadoras

Stützen für Waschgeräte

Embouts lisses pour hydronettoyages



TUBO PIPE	ROSCA THREAD	Referencia Part n°	€
5/16"	M 22x1.5	8305005	20,39
3/8"	M 22x1.5	8305006	21,51

Banjo Metric

Orientables Métricos

Ringaugen metr. nach DIN 7642 RN

Banjo droit Métrique



DN	Ø	Referencia Part n°	€
3/16"	M10x1	841161003	42,61
1/4"	M10x1	841161004	40,39
3/8"	M14x1.5	841161406	44,78
1/4"	M12x1.5	841161204	43,06
5/16"	M16x1.5	841161605	53,13
1/4"	M14x1.5	841161404	39,31
3/8"	M16x1.5	841161606	48,17
3/8"	M18x1.5	841161806	57,61
1/2"	M18x1.5	841161808	68,24
1/2"	M20x1.5	841162008	71,35
1/2"	M22x1.5	841162208	71,35
3/4"	M26x1.5	841162612	89,63

Metric bolt for banjo

Tornillo orientable simple Métrico

Einfache Hohlschraube metr. für Ringauge

Vis creuse simple for banjo Métrique



ROSCA THREAD	Referencia Part n°	€
M12X1.5	Z109212	*
M14X1.5	Z109214	*
M16X1.5	Z109216	*
M18X1.5	Z109218	*
M22X1.5	Z109222	*
M26X1.5	Z109226	*
M30X2	Z109230	*

*See prices in p.180 (BSP ADAPTORS) / *Ver precios en p.180 (ADAPTADORES BSP) / *Vgl. Sie die Preise auf S. 180 (BSP-Adapter) / *Prix à la p.180 (ADAPTEURS BSP)

Hexagonal nuts for hydrowashing machines

Tuercas para terminales hidrolavadoras inox

Edelstahl-Muttern für Hochdruckreiniger

Écrous pour hidronettoyages



ROSCA THREAD	Referencia Part n°	€
M22x1.5	KZTHAP22	14,71

STANDARD SERIES

Conexiones Standard
Standardserie
Embouts série standard

3000 PSI SAE Straight Flange / Code 61

Bridas rectas SAE 3000 PSI

Gerader Flansch SAE 3000 PSI

Bride SAE droite série 3000 PSI



DN	Ø	Referencia Part n°	€
1/2"	30,2	841820808	41,66
1/2"	38,1	841821208	69,57
5/8"	38,1	841821210	59,97
3/4"	38,1	841821212	55,42
3/4"	44,5	841821612	85,90
1"	44,5	841821616	68,28
1"	50,8	841822016	102,11
1"1/4	50,8	841822020	92,61
1"1/4	60,3	841822420	147,48
1"1/2	60,3	841822424	124,64
1"1/2	71,4	841823224	237,48
2"	71,4	841823232	210,78
2" 1/2	84,1	NEW 841824040	417,35
3"	101,6	NEW 841824848	615,84

3000 PSI SAE Flange (90° Elbow) / Code 61

Bridas 90° SAE 3000 PSI

Flansch 90° SAE 3000 PSI

Bride SAE coude 90° série 3000 PSI



DN	Ø	Referencia Part n°	€
1/2"	30,2	841830808	61,88
1/2"	38,1	841831208	80,79
5/8"	38,1	841831210	94,55
3/4"	38,1	841831212	84,99
3/4"	44,5	841831612	124,28
1"	44,5	841831616	109,55
1"	50,8	841832016	176,84
1"1/4	50,8	841832020	163,38
1"1/4	60,3	841832420	259,95
1"1/2	60,3	841832424	232,56
1"1/2	71,4	841833224	391,20
2"	71,4	841833232	349,54

3000 PSI SAE Flange (45° Elbow) / Code 61

Bridas 45° SAE 3000 PSI

Flansch 45° SAE 3000 PSI

Bride SAE coude 45° série 3000 PSI



DN	Ø	Referencia Part n°	€
1/2"	30,2	841840808	61,88
1/2"	38,1	841841208	80,79
5/8"	38,1	841841210	94,55
3/4"	38,1	841841212	84,99
3/4"	44,5	841841612	124,28
1"	44,5	841841616	109,55
1"	50,8	841842016	176,84
1"1/4	50,8	841842020	163,38
1"1/4	60,3	841842420	259,95
1"1/2	60,3	841842424	232,56
1"1/2	71,4	841843224	391,20
2"	71,4	841843232	349,54

6000 PSI SAE Straight Flange / Code 62

Bridas rectas SAE 6000 PSI

Gerader Flansch SAE 6000 PSI

Bride SAE droite série 6000 PSI



DN	Ø	Referencia Part n°	€
1/2"	31,8	842820808	48,99
1/2"	41,3	842821208	78,40
5/8"	41,3	842821210	84,21
3/4"	41,3	842821212	66,96
3/4"	47,6	842821612	92,80
1"	47,6	842821616	85,12
1"	54	842822016	128,08
1"1/4	54	842822020	117,83
1"1/4	63,5	842822420	185,37
1"1/2	63,5	842822424	159,50
1"1/2	79,4	842823224	285,71
2"	79,4	842823232	279,33

6000 PSI SAE Flange (90° Elbow) / Code 62

Bridas 90° SAE 6000 PSI

Flansch 90° SAE 6000 PSI

Bride SAE coude 90° série 6000 PSI



DN	Ø	Referencia Part n°	€
1/2"	31,8	842830808	62,10
1/2"	41,3	842831208	97,92
5/8"	41,3	842831210	106,41
3/4"	41,3	842831212	91,75
3/4"	47,6	842831612	126,21
1"	47,6	842831616	132,96
1"	54	842832016	181,44
1"1/4	54	842832020	172,39
1"1/4	63,5	842832420	284,50
1"1/2	63,5	842832424	306,80
1"1/2	79,4	842833224	405,14
2"	79,4	842833232	372,61

6000 PSI SAE Flange (45° Elbow) / Code 62

Bridas 45° SAE 6000 PSI

Flansch 45° SAE 6000 PSI

Bride SAE coude 45° série 6000 PSI



DN	Ø	Referencia Part n°	€
1/2"	31,8	842840808	62,10
1/2"	41,3	842841208	97,92
5/8"	41,3	842841210	106,41
3/4"	41,3	842841212	91,83
3/4"	47,6	842841612	126,21
1"	47,6	842841616	132,96
1"	54	842842016	181,44
1"1/4	54	842842020	172,39
1"1/4	63,5	842842420	284,58
1"1/2	63,5	842842424	306,01
1"1/2	79,4	842843224	405,14
2"	79,4	842843232	372,61

STANDARD SERIES

Conexiones Standard
Standardserie
Embouts série standard

SAE Split flange

Brida partida pasante

Durchgehender Halbflansch

Demi-bride de fixation



SERIE SERIES	Ø INT. Ø INNER	TAMAÑO SIZE	Referencia Part n°	€
3000 PSI	30.2	1/2"	ZBBP308302	13,86
3000 PSI	38.1	3/4"	ZBBP312381	17,89
3000 PSI	44.5	1"	ZBBP316445	21,30
3000 PSI	50.8	1"1/4	ZBBP320508	30,74
3000 PSI	60.3	1"1/2	ZBBP324603	40,38
3000 PSI	71.4	2"	ZBBP332714	48,78
3000 PSI	84.1	2" 1/2	NEW ZBBP340841	98,57
3000 PSI	102.4	3"	NEW ZBBP3481024	106,02
3000 PSI	127	4"	NEW ZBBP364127	201,88
6000 PSI	31.8	1/2"	ZBBP608318	18,32
6000 PSI	41.3	3/4"	ZBBP612413	26,79
6000 PSI	47.6	1"	ZBBP616476	40,88
6000 PSI	54	1"1/4	ZBBP620540	55,66
6000 PSI	63.5	1"1/2	ZBBP624635	86,01
6000 PSI	79.4	2"	ZBBP632794	149,34

SAE counter-flange

Contrabrida roscada

Gewindegegenflansch

Contre-bride passage total



SERIE SERIES	Ø INT. Ø INNER	TAMAÑO SIZE	Referencia Part n°	€
3000 PSI	30,2	1/2"	ZBCE308302	*
3000 PSI	38,1	3/4"	ZBCE312381	*
3000 PSI	44,5	1"	ZBCE316445	*
3000 PSI	50,8	1"1/4	ZBCE320508	*
3000 PSI	60,3	1"1/2	ZBCE324603	*
3000 PSI	71,4	2"	ZBCE332714	*
6000 PSI	31,8	1/2"	ZBCE608318	*
6000 PSI	41,3	3/4"	ZBCE612413	*
6000 PSI	47,6	1"	ZBCE616476	*
6000 PSI	54	1"1/4	ZBCE620540	*
6000 PSI	63,5	1"1/2	ZBCE624635	*
6000 PSI	79,4	2"	ZBCE632794	*

Seals for 3000/6000 PSI flange

Juntas para bridas SAE 3000/6000 PSI

Dichtungen 3000/6000 PSI-Flansch

Joints pour bride série 3000/6000



TAMAÑO SIZE	Ø INT. Ø INNER	Ø EXT. Ø OUTER	Referencia Part n°	€
1/2"	17.02	25.40	JBR08	*
3/4"	23.36	31.72	JBR12	*
1"	31.24	39.62	JBR16	*
1"1/4	36.07	44.45	JBR20	*
1"1/2	45.34	53.98	JBR24	*
2"	54.86	63.50	JBR32	*

*See prices in Hydraulic and Pneumatic Connectors' Catalogue / *Ver precios en Conducciones Hidráulicas y Neumáticas / *Vgl. Sie die Preise in der Preisliste Hydraulische und Pneumatische Verbindungen. / *Voir prix dans le Catalogue Connectique Hydraulique et Pneumatique

O-rings for 3000/6000 PSI flange

Juntas tóricas para bridas SAE 3000/6000 PSI

O-Ring für 3000/6000 PSI-Flansch

O-rings pour bride série 3000/6000 PSI



TAMAÑO SIZE	Ø INT. Ø INNER	Referencia Part n°	€
1/2"	18.64	18.64X3.53	*
3/4"	24.99	24.99X3.53	*
1"	32.92	32.92X3.53	*
1"1/4	37.70	37.70X3.53	*
1"1/2	47.22	47.22X3.53	*
2"	56.74	56.74X3.53	*

*See prices in Hydraulic and Pneumatic Connectors' Catalogue / *Ver precios en Conducciones Hidráulicas y Neumáticas / *Vgl. Sie die Preise in der Preisliste Hydraulische und Pneumatische Verbindungen. / *Voir prix dans le Catalogue Connectique Hydraulique et Pneumatique

SAE Flange

Brida entera pasante

Durchgehender Vollflansch

Bride de fixation monobloc



SERIE SERIES	Ø INT. Ø INNER	TAMAÑO SIZE	Referencia Part n°	€
3000 PSI	30.2	1/2"	ZBBE308302	14,42
3000 PSI	38.1	3/4"	ZBBE312381	18,60
3000 PSI	44.5	1"	ZBBE316445	21,30
3000 PSI	50.8	1"1/4	ZBBE320508	31,97
3000 PSI	60.3	1"1/2	ZBBE324603	42,00
3000 PSI	71.4	2"	ZBBE332714	49,73
3000 PSI	41	2" 1/2	NEW ZBBE340841	97,59
3000 PSI	102.4	3"	NEW ZBBE3481024	139,26
3000 PSI	127	4"	NEW ZBBE364127	199,87
6000 PSI	31.8	1/2"	ZBBE608318	17,62
6000 PSI	41.3	3/4"	ZBBE612413	26,79
6000 PSI	47.6	1"	ZBBE616476	39,31
6000 PSI	54	1"1/4	ZBBE620540	57,89
6000 PSI	63.5	1"1/2	ZBBE624635	87,70
6000 PSI	79.4	2"	ZBBE632794	149,34

Screws for SAE flanges

Tornillos para bridas SAE

Schrauben für SAE-Flansche

Vis pour brides SAE



ROSCA THREAD	TAMAÑO SIZE	Referencia Part n°	€
M8X30	3000-6000 PSI 1/2"	ZTB8X30	*
M10X35	3000 PSI 3/4"-1"	ZTB10X35	*
M10X40	3000 PSI 1" 1/4 - 6000 PSI 3/4"	ZTB10X40	*
M12X45	3000 PSI 1"1/2-2"-2"1/2-6000 PSI 1"	ZTB12X45	*
M14X45	6000 PSI 1"1/4	ZTB14X45	*
M16X50	3000 PSI 3"-3"1/2"-4"- 6000 PSI 1" 1/2	ZTB16X50	*
M20X70	6000 PSI 2"	ZTB20X70	*

*See prices p.160 / *Ver precios en p.160 / *Vgl. Sie die Preise auf S.160 / *Voir prix p.160

STANDARD SERIES

Conexiones Standard
Standardserie
Embouts série standard

Double hexagonal ORFS Swivel female straight

Hembras giratorias rectas ORFS doble hexagonal

Dichtkopf mit ORFS Ü-Mutter doppelt 6 kt

Femelle droite ORFS double hexagonal



DN	ROSCA THREAD	Referencia Part n°	€
1/4"	9/16"-18h	849010904	30,61
1/4"	11/16"-16h	849011104	41,93
5/16"	11/16"-16h	849011105	39,18
3/8"	11/16"-16h	849011106	34,18
3/8"	13/16"-16h	849011306	43,85
1/2"	13/16"-16h	849011308	38,73
1/2"	1"-14h	849011608	76,59
5/8"	1"-14h	849011610	59,09
1/2"	1"3/16-12h	849011908	88,92
5/8"	1"3/16-12h	NEW 849011910	82,75
3/4"	1"3/16-12h	849011912	62,05
3/4"	1"7/16-12h	849012312	99,29
1"	1"7/16-12h	849012316	85,96
1"1/4"	1"11/16-12h	849012720	163,04
1"1/2"	2"-12h	849013224	189,71
2"	2"-12h	NEW 849013232	338,23

ORFS Male

Machos ORFS

Außengewinde ORFS

Mâle ORFS



DN	ROSCA THREAD	Referencia Part n°	€
1/4"	9/16"-18h	849120904	37,03
5/16"	11/16"-16h	849121105	32,24
3/8"	11/16"-16h	849121106	35,03
1/2"	13/16"-16h	849121308	43,80
5/8"	1"-14h	849121610	64,58
3/4"	1"3/16-12h	849121912	80,61
1"	1"7/16-12h	849122316	110,57
1"1/4"	1"11/16-12h	849122720	152,94
1"1/2"	2"-12h	849123224	227,34

ORFS Swivel female (90° Elbow)

Hembras giratorias 90° ORFS

Dichtkopf 90° ORFS - LOR

Coude 90° femelle ORFS



DN	ROSCA THREAD	Referencia Part n°	€
1/4"	9/16"-18h	849070904	57,70
1/4"	11/16"-16h	849071104	73,04
5/16"	11/16"-16h	849071105	71,39
3/8"	11/16"-16h	849071106	69,18
3/8"	13/16"-16h	849071306	76,49
1/2"	13/16"-16h	849071308	80,25
1/2"	1"-14h	849071608	115,10
5/8"	1"-14h	849071610	101,85
3/4"	1"3/16-12h	849071912	128,15
3/4"	1"7/16-12h	849072312	190,96
1"	1"7/16-12h	849072316	186,06
1"1/4"	1"11/16-12h	849072720	261,42
1"1/2"	2"-12h	849073224	752,35

ORFS Swivel female (45° Elbow)

Hembras giratorias 45° ORFS

Dichtkopf 45° ORFS - LOR

Coude 45° femelle ORFS



DN	ROSCA THREAD	Referencia Part n°	€
1/4"	9/16"-18h	849080904	57,70
1/4"	11/16"-16h	849081104	73,04
5/16"	11/16"-16h	849081105	71,39
3/8"	11/16"-16h	849081106	69,18
3/8"	13/16"-16h	849081306	76,49
1/2"	13/16"-16h	849081308	80,26
1/2"	1"-14h	849081608	115,10
5/8"	1"-14h	849081610	101,85
3/4"	1"3/16-12h	849081912	128,15
3/4"	1"7/16-12h	849082312	190,96
1"	1"7/16-12h	849082316	186,05
1"1/4"	1"11/16-12h	849082720	261,42
1"1/2"	2"-12h	849083224	752,35

O'Ring Boss Male

Macho O'Ring Boss

Außengewinde O'Ring Boss

Mâle O'Ring Boss



DN	ROSCA THREAD	Referencia Part n°	€
1/4"	7/16"-20h UNF	847120604	27,76
3/8"	9/16"-18h UNF	847121006	17,80
1/2"	3/4"-16h UNF	847121208	20,61
5/8"	7/8"-14h UNF	847121610	25,64
3/4"	1"1/16-12h UN	847122012	51,41
1"	1"5/16-12h UN	847122516	86,09

CRIMPING FITTINGS FOR HOSES

PIPE FITTINGS

PIPE FITTINGS II

ADAPTORS

WELDING FITTINGS

INDUSTRIAL FITTINGS

ACCESSORIES

CONTROL COMPONENTS

FLOW MEASURING

TRALE LOK

FITTINGS BW SERIES R12/4SP/4SH NO SKIVE

Conexiones Serie BW R12/4SP/4SH No Pelar
Armaturen Serie BW R12/4SP/4SH ohne Schälung
Embouts R12/4SP/4SH Série BW Sans dénuder

Ferrules R12/4SP/4SH for fittings BW series

Casquillos R12/4SP/4SH para conexiones serie BW

Pressfassungen R12/4SP/4SH für Armaturen Serie BW

Jupes R12/4SP/4SH pour embouts série BW



DN	Referencia Part n°	€
1/2"	ZAC680100800	26,11
5/8"	ZAC680101000	28,67
3/4"	ZAC680101200	36,60
1"	ZAC680101600	47,04
1"1/4	ZAC680102000	72,77
1"1/2	ZAC680102400	106,05
2"	ZAC680103200	158,78

Until end of stock / Hasta fin de existencias / Bis zum Ende des Lagerbestandes / Jusqu'à la fin du stock

Ferrules R13/R15 for fittings BW/BW+ series



Casquillos R13/R15 para serie BW/BW+

Jupes R13/R15 pour embouts série BW/BW+

Boccole a pressione per R13/R15 per raccordi serie BW/BW+



DN	Referencia Part n°	\$
1"1/4	ZAC690102000	105,87
1"1/2	ZAC690102400	132,37
2"	ZAC690103200	194,69

BSP Swivel female 60° cone with o'ring (90° Elbow)

Hembras giratorias 90° BSP cono 60° con junta

Dichtkopf mit BSP Ü-Mutter 60° 90° mit O-Ring

Coude 90° femelle tournante gaz cyl BSP 60° avec joint



DN	ROSCA THREAD	Referencia Part n°	€
1/2"	1/2" BSP	Z661170808*	49,92
3/4"	3/4" BSP	Z661171212*	58,95
1"	1" BSP	Z661171616*	85,08
1"1/4	1"1/4 BSP	Z661172020	145,75

*Until end of stock / Hasta fin de existencias / Bis zum Ende des Lagerbestandes / Jusqu'à la fin du stock

BSP Male 60° cone

Machos cilíndricos BSP 60°

Außengewinde zyl. BSP 60°

Mâle gaz cylindrique BSP 60°



DN	ROSCA THREAD	Referencia Part n°	€
1/2"	1/2" BSP	Z661120808*	27,44
3/4"	3/4" BSP	Z661121212*	41,09
1"	1" BSP	Z661121616*	55,74
1"1/4	1"1/4 BSP	Z661122020	101,02
2"	2" BSP	Z661123232	266,54

*Until end of stock / Hasta fin de existencias / Bis zum Ende des Lagerbestandes / Jusqu'à la fin du stock

BSP Swivel female 60° cone double hexagonal with o'ring

Hembras giratorias rectas BSP cono 60° doble hexagonal con junta

Dichtkopf mit BSP Ü-Mutter 60° doppelt 6 kt mit O-Ring

Femelle tournante gaz cyl BSP 60° double hexagonale avec o'ring



DN	ROSCA THREAD	Referencia Part n°	€
1/2"	1/2" BSP	Z664100808*	38,16
5/8"	5/8" BSP	Z664101210*	61,75
3/4"	3/4" BSP	Z664101212*	56,67
1"	1" BSP	Z664101616*	91,68
1"1/4	1"1/4 BSP	Z664102020	187,99
1"1/2	1"1/2 BSP	Z664102424	249,76
2"	2" BSP	Z664103232	509,57

*Until end of stock / Hasta fin de existencias / Bis zum Ende des Lagerbestandes / Jusqu'à la fin du stock

BSP Swivel female 60° cone with o'ring (45° Elbow)

Hembras giratorias 45° BSP cono 60° con junta

Dichtkopf mit BSP 60° Ü-Mutter kon. 45° mit O-Ring

Hembras giratorias 45° BSP cono 60° avec o'ring



DN	ROSCA THREAD	Referencia Part n°	€
1/2"	1/2" BSP	Z661180808*	49,92
3/4"	3/4" BSP	Z661181212*	58,95
1"	1" BSP	Z661181616*	85,08
1"1/4	1"1/4 BSP	Z661182020	145,75

*Until end of stock / Hasta fin de existencias / Bis zum Ende des Lagerbestandes / Jusqu'à la fin du stock

FITTINGS BW SERIES R12/4SP/4SH NO SKIVE

Conexiones Serie BW R12/4SP/4SH No Pelar
Armaturen Serie BW R12/4SP/4SH ohne Schälung
Embouts R12/4SP/4SH Série BW Sans dénuder

Double hexagonal NPSM female 60° cone with o'ring

Hembras giratorias rectas NPSM cono 60° doble hexagonal con junta

Dichtkopf mit NPSM Ü-Mutter 60° kon. doppelt 6 kt mit O-Ring

Femelle NPSM cono 60° double hexagonal avec joint torique



DN	ROSCA THREAD	Referencia Part n°	€
3/4"	3/4" NPSM	Z664611212*	59,50
1"	1" NPSM	Z664611616*	96,26
1"1/4	1"1/4 NPSM	Z664612020	197,39
1"1/2	1"1/2 NPSM	Z664612424	262,25
2"	2" NPSM	Z664613232	430,71

*Until end of stock / Hasta fin de existencias / Bis zum Ende des Lagerbestandes / Jusqu'à la fin du stock

NPT Male pipe straight

Machos cónicos NPT

Außengewinde NPT

Mâle conique NPT



DN	ROSCA THREAD	Referencia Part n°	€
1/2"	1/2" NPT	Z661610808*	28,16
3/4"	3/4" NPT	Z661611212*	37,59
1"	1" NPT	Z661611616*	53,05
1"1/4	1"1/4 NPT	Z661612020	94,17
1"1/2	1"1/2 NPT	Z661612424	135,79

*Until end of stock / Hasta fin de existencias / Bis zum Ende des Lagerbestandes / Jusqu'à la fin du stock

Double Hexagonal JIC 37° Swivel female

Hembras giratorias rectas JIC 37° doble hexagonal

Dichtkonus mit Ü-Mutter JIC 37° doppelt 6 kt

Femelle JIC 37° double hexagonal



DN	ROSCA THREAD	Referencia Part n°	€
1/2"	3/4" 16h UNF	Z662421208*	30,27
5/8"	7/8" 14h UNF	Z662421410*	43,90
3/4"	1"1/16 12h UN	Z662421712*	56,64
1"	1"1/16 12h UNF	Z662421716*	69,18
1"	1"5/16 12h UN	Z662422116*	86,64
1"1/4	1"5/8 12h UN	Z662422620	208,00
1"1/2	1"7/8 12h UN	Z662423024	312,53
2"	2"1/2 12h UN	Z662424032	464,91

*Until end of stock / Hasta fin de existencias / Bis zum Ende des Lagerbestandes / Jusqu'à la fin du stock

JIC 37° Swivel female (90° Elbow)

Hembras giratorias 90° JIC 37°

Dichtkonus mit Ü-Mutter 37° JIC 90°

Coude 90° femelle JIC 37°



DN	ROSCA THREAD	Referencia Part n°	€
1/2"	3/4" 16h UNF	Z661381208*	37,20
5/8"	7/8" 14h UNF	Z661381410*	48,14
3/4"	1"1/16 12h UN	Z661381712*	59,52
1"	1"1/16 12h UNF	Z661381716*	102,24
1"	1"5/16 12h UN	Z661382116*	85,30
1"1/4	1"5/8 12h UN	Z661382620	131,78
1"1/2	1"7/8 12h UN	Z661383024	188,90
2"	2"1/2 12h UN	Z661384032	385,29

*Until end of stock / Hasta fin de existencias / Bis zum Ende des Lagerbestandes / Jusqu'à la fin du stock

JIC 37° Swivel female (45° Elbow)

Hembras giratorias 45° JIC 37°

Dichtkonus mit Ü-Mutter 37° JIC 45°

Coude 45° femelle JIC 37°



DN	ROSCA THREAD	Referencia Part n°	€
1/2"	3/4" 16h UNF	Z661391208*	37,21
5/8"	7/8" 14h UNF	Z661391410*	48,14
3/4"	1"1/16 12h UN	Z661391712*	59,52
1"	1"5/16 12h UN	Z661392116*	85,30
1"1/4	1"5/8 12h UN	Z661392620	131,78
1"1/2	1"7/8 12h UN	Z661393024	188,90
2"	2"1/2 12h UN	Z661394032	385,29

*Until end of stock / Hasta fin de existencias / Bis zum Ende des Lagerbestandes / Jusqu'à la fin du stock

JIC 37° male with o'ring

Machos JIC 37° con junta

Außengewinde JIC 37° mit O-Ring

Mâle JIC 37° avec joint torique



DN	ROSCA THREAD	Referencia Part n°	€
1/2"	3/4" 16h UNF	Z661411208*	32,07
5/8"	7/8" 14h UNF	Z661411410*	37,99
3/4"	1"1/16 12h UNF	Z661411712*	49,73
1"	1"5/16 12h UNF	Z661412116*	67,47
1"1/4	1"5/8 12h UNF	Z661412620	102,55

*Until end of stock / Hasta fin de existencias / Bis zum Ende des Lagerbestandes / Jusqu'à la fin du stock

FITTINGS BW SERIES R12/4SP/4SH NO SKIVE

Conexiones Serie BW R12/4SP/4SH No Pelar
Armaturen Serie BW R12/4SP/4SH ohne Schälung
Embouts R12/4SP/4SH Série BW Sans dénuder

ORFS Swivel female straight

Hembras giratorias rectas ORFS doble hexagonal

Dichtkopf mit Ü-Mutter ORFS doppelt 6 kt

Femelle droite ORFS



DN	ROSCA THREAD	Referencia Part n°	€
1/2"	13/16"-16h	Z669011308*	50,96
3/4"	1"3/16-12h	Z669011912*	77,56
1"	1"7/16-12h	Z669012316*	113,88
1" 1/4	1"11/16-12h	Z669012720	149,11
1" 1/2	2"-12h	Z669013224	213,47

*Until end of stock / Hasta fin de existencias / Bis zum Ende des Lagerbestandes / Jusqu'à la fin du stock

ORFS Swivel female (90° Elbow)

Hembras giratorias 90° ORFS asiento plano

Dichtkopf mit Ü-Mutter ORFS 90° flachdichtend

Coude 90° femelle ORFS



DN	ROSCA THREAD	Referencia Part n°	€
1"	13/16"-16h	Z669071308*	96,46
3/4"	1"3/16-12h	Z669071912*	218,52
1"	1"7/16-12h	Z669072316*	318,94
1" 1/4	1"11/16-12h	Z669072720	447,20

*Until end of stock / Hasta fin de existencias / Bis zum Ende des Lagerbestandes / Jusqu'à la fin du stock

ORFS Swivel female (45° Elbow)

Hembras giratorias 45° ORFS asiento plano

Dichtkopf mit Ü-Mutter 45° ORFS flachdichtend

Coude 45° femelle ORFS



DN	ROSCA THREAD	Referencia Part n°	€
3/4"	1"3/16-12h	Z669081912*	218,52
1"	1"7/16-12h	Z669082316*	318,94
1" 1/4	1"11/16-12h	Z669082720	447,20

*Until end of stock / Hasta fin de existencias / Bis zum Ende des Lagerbestandes / Jusqu'à la fin du stock

ORFS Male

Machos ORFS

Außengewinde ORFS

Mâle ORFS



DN	ROSCA THREAD	Referencia Part n°	€
3/4"	1"3/16-12h	Z669121912	128,12

Until end of stock / Hasta fin de existencias / Bis zum Ende des Lagerbestandes / Jusqu'à la fin du stock

Metric swivel female 24° seat with o'ring

Hembras giratorias Métricas cono 24° con junta tórica

Dichtkopf mit Ü-Mutter kon. 24° DKO

Femelle Métrique 24° avec o'ring



DN	TUBO PIPE	SERIE SERIES	ROSCA THREAD	Referencia Part n°	€
1/2"	16	S	M24x1.5	Z66204241608*	27,53
3/4"	20	S	M30x2	Z66204302012*	46,56
3/4"	25	S	M36X2	Z66204362512*	61,42
1"	25	S	M36X2	Z66204362516*	83,09
1"	30	S	M42X2	Z66204423016*	74,04
1"1/4	38	S	M52X2	Z66204523820	106,35
1"1/2	38	S	M52X2	Z66204523824	141,10

*Until end of stock / Hasta fin de existencias / Bis zum Ende des Lagerbestandes / Jusqu'à la fin du stock

Metric swivel female 24° seat with o'ring (90° Elbow)

Hembras giratorias 90° Métricas cono 24° con junta tórica

Dichtkegel mit Ü-Mutter kon. 24° DKO 90°

Coude 90° femelle Métrique 24° avec o'ring



DN	TUBO PIPE	SERIE SERIES	ROSCA THREAD	Referencia Part n°	€
3/4"	20	S	M30x2	Z66205302012*	64,12
3/4"	25	S	M36X2	Z66205362512*	97,96
1"	25	S	M36X2	Z66205362516*	136,15
1"	30	S	M42X2	Z66205423016*	123,63
1"1/4	38	S	M52X2	Z66205523820	179,17

*Until end of stock / Hasta fin de existencias / Bis zum Ende des Lagerbestandes / Jusqu'à la fin du stock

Metric swivel female 24° seat with o'ring (45° Elbow)

Hembras giratorias 45° Métricas cono 24° con junta tórica

Dichtkegel mit Ü-Mutter kon. 24° DKO 45°

Coude 45° femelle Métrique 24° avec o'ring



DN	TUBO PIPE	SERIE SERIES	ROSCA THREAD	Referencia Part n°	€
3/4"	20	S	M30x2	Z66206302012*	64,12
3/4"	25	S	M36X2	Z66206362512*	97,96
1"	30	S	M42X2	Z66206423016*	123,63
1"1/4	38	S	M52X2	Z66206523820	179,17

*Until end of stock / Hasta fin de existencias / Bis zum Ende des Lagerbestandes / Jusqu'à la fin du stock

Metric male stud 24° cone

Machos hijos Métricos cono 24°

Außengewinde metr. kon. 24°

Mâle Métrique cone 24°

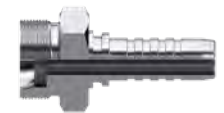

DN	TUBO PIPE	SERIE SERIES	ROSCA THREAD	Referencia Part n°	€
3/4"	20	S	M30x2	Z66203302012*	49,27
3/4"	25	S	M36X2	Z66203362512*	68,84
1"	30	S	M42X2	Z66203423016*	78,83
1"1/4	38	S	M52x2	Z66203523820	135,30

*Until end of stock / Hasta fin de existencias / Bis zum Ende des Lagerbestandes / Jusqu'à la fin du stock

FITTINGS BW SERIES R12/4SP/4SH NO SKIVE

Conexiones Serie BW R12/4SP/4SH No Pelar
Armaturen Serie BW R12/4SP/4SH ohne Schälung
Embouts R12/4SP/4SH Série BW Sans dénuder

3000 PSI SAE Straight Flange / Code 61

Bridas rectas SAE 3000 PSI

Gerader Flansch SAE 3000 PSI

Bride SAE droite série 3000 PSI



DN	Ø	Referencia Part n°	€
1/2"	30.2	Z661820808*	57,28
3/4"	38.1	Z661821212*	60,75
1"	44.5	Z661821616*	75,46
1"1/4	50.8	Z661822020	125,74
1"1/4	60.3	NEW Z661822420	148,28
1"1/2	60.3	Z661822424	160,60
2"	71.4	Z661823232	250,43

*Until end of stock / Hasta fin de existencias / Bis zum Ende des Lagerbestandes / Jusqu'à la fin du stock

3000 PSI SAE Flange (90° Elbow) / Code 61

Bridas a 90° SAE 3000 PSI

Flansch 90° SAE 3000 PSI

Bride SAE coude 90° série 3000 PSI



DN	Ø	Referencia Part n°	€
3/4"	38.1	Z661831212*	87,59
1"	44.5	Z661831616*	130,03
1"1/4	50.8	Z661832020	169,39
1"1/2	60.3	Z661832424	280,05
2"	71.4	Z661833232	393,04

*Until end of stock / Hasta fin de existencias / Bis zum Ende des Lagerbestandes / Jusqu'à la fin du stock

3000 PSI SAE Flange (45° Elbow) / Code 61

Bridas a 45° SAE 3000 PSI

Flansch 45° SAE 3000 PSI

Bride SAE coude 45° série 3000 PSI



DN	Ø	Referencia Part n°	€
3/4"	38.1	Z661841212*	87,59
1"	44.5	Z661841616*	130,03
1"1/4	50.8	Z661842020	169,39
1"1/2	60.3	Z661842424	280,05
2"	71.4	Z661843232	393,04

*Until end of stock / Hasta fin de existencias / Bis zum Ende des Lagerbestandes / Jusqu'à la fin du stock

6000 PSI SAE Straight Flange / Code 62

Bridas recta SAE 6000 PSI

Gerader Flansch SAE 6000 PSI

Bride SAE droite série 6000 PSI



DN	Ø	Referencia Part n°	€
1/2"	31.8	Z662820808*	61,24
3/4"	41.3	Z662821212*	69,38
1"	47.6	Z662821616*	83,34
1"1/4	54	Z662822020	127,63
1"1/2	63.5	Z662822424	162,73
2"	79.4	Z662823232	262,83

*Until end of stock / Hasta fin de existencias / Bis zum Ende des Lagerbestandes / Jusqu'à la fin du stock

6000 PSI SAE Flange (90° Elbow) / Code 62

Bridas a 90° SAE 6000 PSI

Flansch 90° SAE 6000 PSI

Bride SAE coude 90° série 6000 PSI



DN	Ø	Referencia Part n°	€
1/2"	31.8	Z662830808*	77,62
5/8"	41.3	Z662831210*	118,94
3/4"	41.3	Z662831212*	93,87
1"	47.6	Z662831616*	131,53
1"1/4	54	Z662832020	174,26
1"1/2	63.5	Z662832424	285,65
2"	79.4	Z662833232	406,52

*Until end of stock / Hasta fin de existencias / Bis zum Ende des Lagerbestandes / Jusqu'à la fin du stock

6000 PSI SAE Flange (45° Elbow) / Code 62

Bridas a 45° SAE 6000 PSI

Flansch 45° SAE 6000 PSI

Bride SAE coude 45° série 6000 PSI



DN	Ø	Referencia Part n°	€
1/2"	31.8	Z662840808*	77,62
5/8"	41.3	Z662841210*	118,94
3/4"	41.3	Z662841212*	93,87
1"	47.6	Z662841616*	131,53
1"1/4	54	Z662842020	174,26
1"1/2	63.5	Z662842424	285,65
2"	79.4	Z662843232	406,52

*Until end of stock / Hasta fin de existencias / Bis zum Ende des Lagerbestandes / Jusqu'à la fin du stock

INTERLOCK SERIES

Conexiones Interlock

Armaturen Interlock

Embouts Interlock

Ferrules DIN 20023 - 4SH Interlock

Casquillos Interlock 4SH

Pressfassungen 4 SH DIN 20023/EN 856-4SH

Jupes à sertir DIN 20023 - 4SH Interlock



DN	MANGUERA HOSE	Referencia Part n°	€
3/4"	4SH / R13 / R15	ZA610101200	34,61
1"	4SH / R13 / R15	ZA610101600	50,93
1"1/4	4SH	ZA610102000	78,63
1"1/2	4SH	ZA610102400	99,40
2"	4SH	ZA610103200	155,00

Ferrules SAE 100 R13/R15 Interlock

Casquillos Interlock R13/R15

Pressfassungen SAE 100 R13/R15

Jupes à sertir R13/R15 Interlock



DN	Referencia Part n°	€
1" 1/4	Z610102000	87,38
1"1/2	Z610102400	109,25
2"	Z610103200	160,68

3/4" and 1" are the same ferrules as in 4SH / Para 3/4" y 1" son los mismos casquillos que en 4SH / Für 3/4" und 1" werden die gleichen Presshülsen wie für 4SH verwendet / 3/4" et 1" sont les mêmes jupes que pour 4SH

BSP 60° cone Swivel female Interlock with o'ring

Hembras giratorias rectas rosca BSP cono 60°
Interlock con junta

Dichtkopf mit BSP Ü-Mutter Interlock DKR mit
O-Ring

Femelle droite gaz cylindrique BSP 60° Interlock
avec joint torique



DN	ROSCA THREAD	Referencia Part n°	€
3/4"	3/4" BSP	Z641001212	38,88
1"	1" BSP	Z641001616	55,13
1"1/4	1"1/4 BSP	Z641002020	90,16
1"1/2	1"1/2 BSP	Z641002424	108,58

Until end of stock / Hasta fin de existencias / Bis zum Ende des Lagerbestandes / Jusqu'à la fin du stock

BSP 60° cone Swivel female Interlock (90° Elbow) with o'ring

Hembras giratoria 90° BSP cono 60° Interlock con
junta

Dichtkopf mit BSP 60° Ü-Mutter Interlock DKR 90°
kon. mit O-Ring

Coude 90° femelle gaz cylindrique BSP 60°
Interlock avec joint torique



DN	ROSCA THREAD	Referencia Part n°	€
3/4"	3/4" BSP	Z641071212	60,50
1"	1" BSP	Z641071616	96,71
1"1/4	1"1/4 BSP	Z641072020	142,35
1"1/2	1"1/2 BSP	Z641072424	225,09
2"	2" BSP	Z641073232	432,39

Until end of stock / Hasta fin de existencias / Bis zum Ende des Lagerbestandes / Jusqu'à la fin du stock

BSP 60° Male cone

Machos cilíndricos BSP cono 60° Interlock

BSP Einschraubzapfen zyl. DIN 3852 Form A AFR

Mâle gaz cylindrique BSP 60° Interlock



DN	ROSCA THREAD	Referencia Part n°	€
3/4"	3/4" BSP	Z641121212	43,34
1"	1" BSP	Z641121616	72,05
1"1/4	1"1/4 BSP	Z641122020	109,66
1"1/2	1"1/2 BSP	Z641122424	158,37
2"	2" BSP	Z641123232	266,96

BSP 60° cone Swivel female Interlock (45° Elbow) with o'ring

Hembras giratoria 45° BSP cono 60° Interlock con
junta

Dichtkopf mit BSP 60° Ü-Mutter Interlock DKR 45°
kon. mit O-Ring

Coude 45° femelle gaz cylindrique BSP 60°
Interlock avec joint torique



DN	ROSCA THREAD	Referencia Part n°	€
3/4"	3/4" BSP	Z641081212	60,50
1"	1" BSP	Z641081616	96,58
1"1/4	1"1/4 BSP	Z641082020	142,35
1"1/2	1"1/2 BSP	Z641082424	225,09
2"	2" BSP	Z641083232	432,39

Until end of stock / Hasta fin de existencias / Bis zum Ende des Lagerbestandes / Jusqu'à la fin du stock

NPT Male pipe straight Interlock

Machos cónicos NPT Interlock

Außengewinde NPT AGN Interlock

Mâle conique NPT Interlock



DN	ROSCA THREAD	Referencia Part n°	€
3/4"	3/4" NPT	Z641611212	45,17
1"	1" NPT	Z641611616	66,74
1"1/4	1"1/4 NPT	Z641612020	112,44
1"1/2	1"1/2 NPT	Z641612424	146,51
2"	2" NPT	Z641613232	270,82

INTERLOCK SERIES

Conexiones Interlock
Armaturen Interlock
Embouts Interlock

BSP 60° cone Swivel female Interlock with o'ring wire nut NEW

Hembras giratorias rectas BSP cono 60° con junta (tca engargolada)

Dichtkopf mit BSP Ü-Mutter Interlock DKR mit O-Ring Muffenmutter

Femelle droite gaz cylindrique BSP 60° Interlock avec joint torique écrou à jonc



DN	ROSCA THREAD	Referencia Part n°	€
3/4"	3/4" BSP	Z645001212	38,79
1"	1" BSP	Z645001616	54,18
1"1/4	1"1/4 BSP	Z645002020	80,50
1"1/2	1"1/2 BSP	Z645002424	96,94
2"	2" BSP	Z645003232	167,28

BSP 60° cone Swivel female Interlock (45° Elbow) with o'ring wire nut NEW

Hembras giratorias 45° BSP cono 60° con junta (tca engargolada)

Dichtkopf mit BSP 60° Ü-Mutter Interlock DKR 45° kon. mit O-Ring Muffenmutter

Coude 45° femelle gaz cylindrique BSP 60° Interlock avec joint torique écrou à jonc



DN	ROSCA THREAD	Referencia Part n°	€
3/4"	3/4" BSP	Z645081212	*
1"	1" BSP	Z645081616	*
1"1/4	1"1/4 BSP	Z645082020	*
1"1/2	1"1/2 BSP	Z645082424	*
2"	2" BSP	Z645083232	*

BSP 60° cone Swivel female Interlock (90° Elbow) with o'ring wire nut NEW

Hembras giratorias 90° BSP cono 60° con junta (tca engargolada)

Dichtkopf mit BSP 60° Ü-Mutter Interlock DKR 90° kon. mit O-Ring Muffenmutter

Coude 90° femelle gaz cylindrique BSP 60° Interlock avec joint torique écrou à jonc



DN	ROSCA THREAD	Referencia Part n°	€
3/4"	3/4" BSP	Z645071212	*
1"	1" BSP	Z645071616	*
1"1/4	1"1/4 BSP	Z645072020	*
1"1/2	1"1/2 BSP	Z645072424	*
2"	2" BSP	Z645073232	*

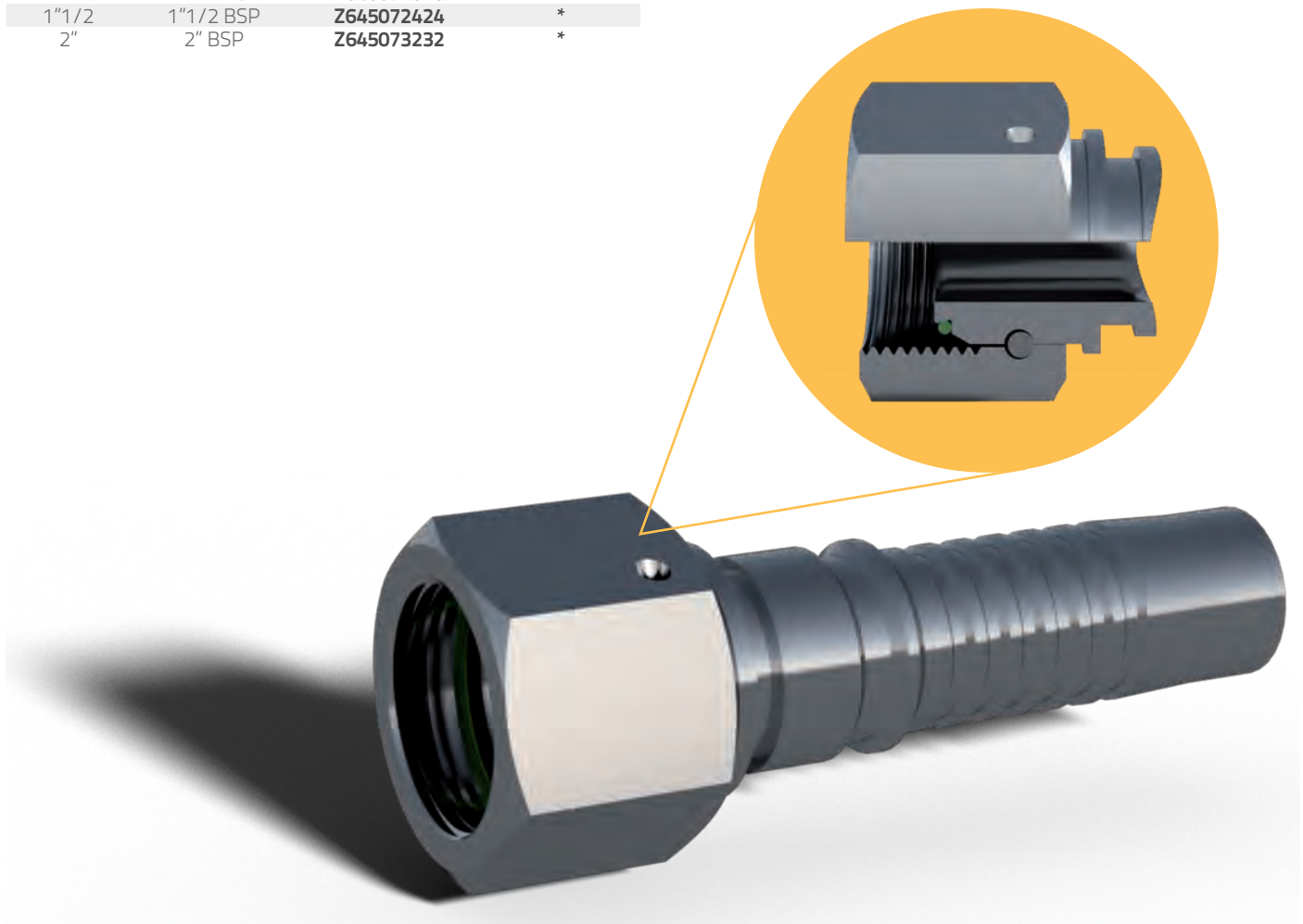

INTERLOCK SERIES

Conexiones Interlock

Armaturen Interlock

Embouts Interlock

Double hexagonal JIC 37° Swivel female

Hembras giratorias JIC 37° doble hexagonal Interlock

Dichtkonus einteilig Ü-Mutter 37° JIC doppelt 6 kt Interlock

Femelle JIC 37° double hexagonal



DN	ROSCA THREAD	Referencia Part n°	€
3/4"	1"1/16 12h UN	Z642421712	55,87
1"	1"5/16 12h UN	Z642422116	86,32
1"1/4	1"5/8 12h UN	Z642422620	203,83
1"1/2	1"7/8 12h UN	Z642423024	311,38
2"	2"1/2 12h UN	Z642424032	458,59

JIC 37° male Interlock

Machos JIC 37° Interlock

Außengewinde JIC 37°

Mâle JIC 37° Interlock



DN	ROSCA THREAD	Referencia Part n°	€
3/4"	1"1/16 12h UN	Z641401712	62,11
1"	1"5/16 12h UN	Z641402116	96,77
1"1/4	1"5/8 12h UN	Z641402620	129,72
1"1/2	1"7/8 12h UN	Z641403024	120,73
2"	2"1/2 12h UN	Z641404032	251,07

JIC 37° Swivel female Interlock

Hembras giratorias rectas JIC 37° Interlock

Dichtkonus mit Ü-Mutter JIC 37° Interlock

Femelle tourn.droite JIC 37° Interlock



DN	ROSCA THREAD	Referencia Part n°	€
3/4"	1"1/16 12h UN	Z641421712	42,15
1"	1"5/16 12h UN	Z641422116	45,67
1"1/4	1"5/8 12h UN	Z641422620	85,10
1"1/4	1"7/8 12h UN	Z641423020	120,44
1"1/2	1"7/8 12h UN	Z641423024	119,26
2"	2"1/2 12h UN	Z641424032	211,92

JIC 37° Swivel female Interlock (90° Elbow)

Hembras giratorias 90° JIC 37° Interlock

JIC 37° Dichtkonus 90° DKJ 90° interlock

Coude 90° femelle tournante JIC 37° Interlock



DN	ROSCA THREAD	Referencia Part n°	€
3/4"	1"1/16 12h UN	Z641381712	60,29
1"	1"5/16 12h UN	Z641382116	106,22
1"1/4	1"5/8 12h UN	Z641382620	147,05
1"1/2	1"7/8 12h UN	Z641383024	237,91
2"	2"1/2 12h UN	Z641384032	469,65

JIC 37° Swivel female Interlock (45° Elbow)

Hembras giratorias 45° JIC 37° Interlock

Dichtkonus JIC 37° 45° DKJ 45° Interlock

Coude 45° femelle tournante JIC 37° Interlock



DN	ROSCA THREAD	Referencia Part n°	€
3/4"	1"1/16 12h UN	Z641391712	60,29
1"	1"5/16 12h UN	Z641392116	106,05
1"1/4	1"5/8 12h UN	Z641392620	147,05
1"1/2	1"7/8 12h UN	Z641393024	237,91
2"	2"1/2 12h UN	Z641394032	469,65

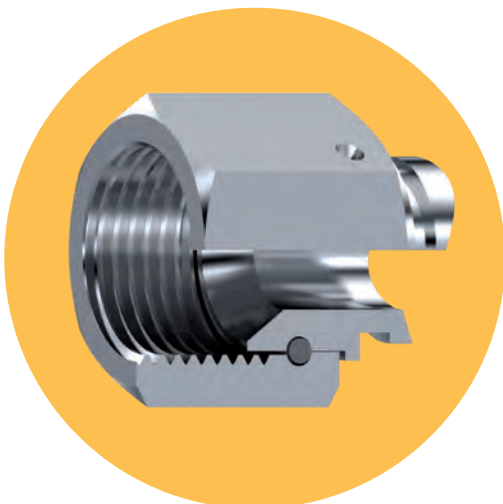

Bajo Consulta
On Request

INTERLOCK SERIES

Conexiones Interlock
Armaturen Interlock
Embouts Interlock

Metric swivel female 24° seat serie S Interlock with o'ring

Hembras giratorias rectas Métricas cono 24°
Interlock con junta tórica
Dichtkegel mit Ü-Mutter O-Ring DIN 20078
Interlock

Femelle droite Métrique 24° Interlock avec o'ring



DN	TUBO PIPE	SERIE SERIES	ROSCA THREAD	Referencia Part n°	€
3/4"	20	S	M30x2	Z64204302012	46,39
3/4"	25	S	M36x2	Z64204362512	61,31
1"	30	S	M42x2	Z64204423016	80,61
1"1/4	38	S	M52x2	Z64204523820	115,82
1"1/2	38	S	M52x2	Z64204523824 NEW	161,32

Metric swivel female 24° seat serie S Interlock with o'ring (90° Elbow)

Hembras 90° Métricas cono 24° Interlock con junta tórica
Dichtkegel mit Ü-Mutter O-Ring DIN 20078
90° Interlock

Coude 90° femelle Métrique 24° Interlock avec o'ring



DN	TUBO PIPE	SERIE SERIES	ROSCA THREAD	Referencia Part n°	€
3/4"	20	S	M30x2	Z64205302012	69,23
3/4"	25	S	M36x2	Z64205362512	105,64
1"	30	S	M42x2	Z64205423016	142,07
1"1/4	38	S	M52x2	Z64205523820	191,24
1"1/2	38	S	M52x2	Z64205523824 NEW	265,89

Metric swivel female 24° seat serie S Interlock with o'ring (45° Elbow)

Hembras 45° Métricas cono 24° Interlock con junta tórica
Dichtkegel mit Ü-Mutter O-Ring DIN 20078
45° Interlock

Coude 45° femelle Métrique 24° Interlock avec o'ring



DN	TUBO PIPE	SERIE SERIES	ROSCA THREAD	Referencia Part n°	€
3/4"	20	S	M30x2	Z64206302012	69,23
3/4"	25	S	M36x2	Z64206362512	105,64
1"	30	S	M42x2	Z64206423016	142,07
1"1/4	38	S	M52x2	Z64206523820	191,24

Metric male stud 24° cone serie S Interlock

Machos Métricos cono 24° Interlock

Gewindezapfen DIN 20078 Interlock

Mâle Métrique cone 24° Interlock



DN	TUBO PIPE	SERIE SERIES	ROSCA THREAD	Referencia Part n°	€
3/4"	20	S	M30x2	Z64203302012	52,75
3/4"	25	S	M36x2	Z64203362512	85,59
1"	30	S	M42x2	Z64203423016	102,44
1"1/4	38	S	M52x2	Z64203523820	142,38

Interlock ORFS Swivel female straight

Hembras giratorias rectas ORFS Interlock

Dichtkopf mit ORFS Ü-Mutter - Interlock

Femelle droite ORFS Interlock



DN	ROSCA THREAD	Referencia Part n°	€
3/4"	1"3/16-12h	Z649011912	73,49
1"	1"7/16-12h	Z649012316	133,91
1"1/4	1"11/16-12h	Z649012720	156,17
1"1/2	2"-12h	Z649013224	235,64

Interlock ORFS Male

Machos ORFS Interlock

Außengewinde ORFS Interlock

Mâle ORFS Interlock



DN	ROSCA THREAD	Referencia Part n°	€
3/4"	1"3/16-12h	Z649121912	128,32
1"	1"7/16-12h	Z649122316	190,69
1"1/4	1"11/16-12h	Z649122720	263,76
1"1/2	2"-12h	Z649123224	392,09

Interlock ORFS Swivel female (90° Elbow)

Hembras giratorias 90° ORFS Interlock

Dichtkopf 90° ORFS Interlock

Coude 90° femelle ORFS Interlock



DN	ROSCA THREAD	Referencia Part n°	€
3/4"	1"3/16-12h	Z649071912	218,86
1"	1"7/16-12h	Z649072316	317,77
1"1/4	1"11/16-12h	Z649072720	445,56
1"1/2	2"-12h	Z649073224	1.284,98

Interlock ORFS Swivel female (45° Elbow)

Hembras giratorias 45° ORFS Interlock

Dichtkopf 45° ORFS Interlock

Coude 45° femelle ORFS Interlock



DN	ROSCA THREAD	Referencia Part n°	€
3/4"	1"3/16-12h	Z649081912	218,86
12	1"7/16-12h	Z649082316	317,77
1"1/4	1"11/16-12h	Z649082720	445,56
1"1/2	2"-12h	Z649083224	1.284,98

INTERLOCK SERIES

Conexiones Interlock

Armaturen Interlock

Embouts Interlock

3000 PSI SAE Straight Flange Interlock / Code 61

Bridas rectas SAE 3000 PSI Interlock

Gerader Flansch SAE 3000 PSI Interlock

Bride SAE droite série 3000 PSI Interlock



DN	Ø	Referencia Part n°	€
3/4"	38,1	Z641821212	74,30
3/4"	44,5	Z641821612	95,13
1"	44,5	Z641821616	86,34
1"	50,8	Z641822016	102,21
1"1/4	50,8	Z641822020	123,22
1"1/4	60,3	Z641822420	167,63
1"1/2	60,3	Z641822424	179,86
1"1/2	71,4	Z641823224	246,96
2"	71,4	Z641823232	280,91

3000 PSI SAE Flange Interlock (90° Elbow) / Code 61

Bridas 90° SAE 3000 PSI Interlock

Flansch 90° SAE 3000 PSI Interlock

Coude 90° bride SAE série 3000 PSI Interlock



DN	Ø	Referencia Part n°	€
3/4"	38,1	Z641831212	86,40
3/4"	44,45	Z641831612	127,57
1"	44,45	Z641831616	124,68
1"	50,8	Z641832016	195,98
1"1/4	50,8	Z641832020	171,75
1"1/4	60,33	Z641832420	271,56
1"1/2	60,3	Z641832424	280,49
1"1/2	71,4	Z641833224	401,69
2"	71,4	Z641833232	393,66

3000 PSI SAE Flange Interlock (45° Elbow) / Code 61

Bridas 45° SAE 3000 PSI Interlock

Flansch 45° SAE 3000 PSI Interlock

Coude 45° bride SAE série 3000 PSI Interlock



DN	Ø	Referencia Part n°	€
3/4"	38,1	Z641841212	86,40
3/4"	44,5	Z641841612	127,57
1"	44,5	Z641841616	125,54
1"	50,8	Z641842016	195,98
1"1/4	50,8	Z641842020	172,61
1"1/4	60,3	Z641842420	271,56
1"1/2	60,3	Z641842424	280,49
2"	71,4	Z641843224	401,69
2"	71,4	Z641843232	393,66

6000 PSI SAE Straight Flange Interlock / Code 62

Bridas Rectas SAE 6000 PSI Interlock

Gerader Flansch SAE 6000 PSI Interlock

Bride SAE droite série 6000 PSI Interlock



DN	Ø	Referencia Part n°	€
3/4"	41,3	Z642821212	68,43
3/4"	47,63	Z642821612	99,45
1"	47,63	Z642821616	88,56
1"	53,98	Z642822016	126,15
1"1/4	54	Z642822020	125,06
1"1/4	63,5	Z642822420	177,27
1"1/2	63,5	Z642822424	171,37
1"1/2	79,38	Z642823224	289,87
2"	79,38	Z642823232	273,77

6000 PSI SAE Flange Interlock (90° Elbow) / Code 62

Bridas 90° SAE 6000 PSI Interlock

Flansch 90° SAE 6000 PSI Interlock

Coude 90° bride SAE série 6000 PSI Interlock



DN	Ø	Referencia Part n°	€
3/4"	41,3	Z642831212	108,35
3/4"	44,45	Z642831612	134,64
1"	47,63	Z642831616	146,77
1"	53,98	Z642832016	198,91
1"1/4	53,98	Z642832020	188,96
1"1/4	63,5	Z642832420	289,14
1"1/2	63,5	Z642832424	282,66
1"1/2	79,38	Z642833224	432,59
2"	79,38	Z642833232	409,01

6000 PSI SAE Flange Interlock (45° Elbow) / Code 62

Bridas 45° SAE 6000 PSI Interlock

Flansch 45° SAE 6000 PSI Interlock

Coude 45° bride SAE série 6000 PSI Interlock



DN	Ø	Referencia Part n°	€
3/4"	41,3	Z642841212	109,51
3/4"	47,6	Z642841612	134,64
1"	47,6	Z642841616	145,58
1"	54	Z642842016	198,91
1"1/4	54	Z642842020	188,96
1"1/4	63,5	Z642842420	289,14
1"1/2	63,5	Z642842424	282,66
1"1/2	79,4	Z642843224	432,59
2"	79,4	Z642843232	409,01

ONE PIECE FITTINGS 43 SERIES R1AT/R2AT/1SN/2SN/R16/2SC/R17

Conexiones una sola pieza Serie 43 R1AT/R2AT/1SN/2SN/R16/2SC/R17

Einteilige Armaturen Serie 43 R1AT/R2AT/1SN/2SN/R16/2SC/R17

Embouts pré-sertis R1AT/R2AT/1SN/2SN/R16/2SC/R17 Série 43

One piece JIC 37° Swivel female

Hembras giratorias rectas una sola pieza JIC 37°

Dichtkopf mit Ü-Mutter einteilig JIC 37°

Femelle pré-sertie JIC 37°



DN	ROSCA THREAD	Referencia Part n°	€
1/4"	7/16" 20h UNF	881420704	22,44
1/4"	1/2" 20h UNF	881420804	23,68
5/16"	1/2" 20h UNF	NEW 881420805	28,76
5/16"	9/16" 18h UNF	NEW 881420905	27,73
3/8"	9/16" 18h UNF	881420906	27,66
1/2"	3/4" 16h UNF	881421208	31,63
5/8"	7/8" 14h UNF	881421410	40,56
1/2"	1"1/16 12h UN	881421708	52,88
5/8"	1"1/16 12h UN	881421710	48,35
3/4"	1"1/16 12h UN	881421712	50,21
1"	1"1/16 12h UN	NEW 881421716	83,56
3/4"	1"5/16 12h UN	NEW 881422112	64,48
1"	1"5/16 12h UN	881422116	84,48
5/8"	1"5/8 12h UN	NEW 881422616	114,83
1"1/4"	1"5/8 12h UN	881422620	150,89
1"1/2"	1"7/8 12h UN	881423024	195,66
2"	2"1/2 12h UN	881424032	337,93

One piece JIC 37° Swivel female (90° Elbow)

Hembras giratorias 90° una sola pieza JIC 37°

Dichtkopf einteilig Ü-Mutter 37° JIC 90°

Coude 90° femelle pré-sertie JIC 37°



DN	ROSCA THREAD	Referencia Part n°	€
1/4"	7/16" 20h UNF	881380704	31,87
5/16"	1/2" 20h UNF	NEW 881380805	50,23
3/8"	9/16" 18h UNF	881380906	40,21
1/2"	3/4" 16h UNF	881381208	45,91
1/2"	7/8" 14h UNF	881381408	48,64
5/8"	7/8" 14h UNF	881381410	60,05
3/4"	1"1/16 12h UN	881381712	74,97
3/4"	1"5/16 12h UN	881382112	103,73
1"	1"5/16 12h UN	881382116	119,50
1"1/4"	1"5/8 12h UN	881382620	209,01
1"1/2"	1"7/8 12h UN	881383024	315,26
2"	2"1/2 12h UN	881384032	620,24

One piece JIC 37° Swivel female (45° Elbow)

Hembras giratorias 45° una sola pieza JIC 37°

Dichtkopf JIC 37° einteilig 45°

Coude 45° femelle pré-sertie JIC 37°



DN	ROSCA THREAD	Referencia Part n°	€
1/4"	7/16" 20h UNF	881390704	32,94
1/4"	9/16" 18h UNF	881390904	46,72
3/8"	9/16" 18h UNF	881390906	41,74
3/8"	3/4" 16h UNF	881391206	46,74
1/2"	3/4" 16h UNF	881391208	43,36
1/2"	7/8" 14h UNF	881391408	49,81
3/4"	1"1/16 12h UN	881391712	74,97
1"	1"5/16 12h UN	881392116	119,50
1"1/4"	1"5/8 12h UN	881392620	209,01
1"1/2"	1"7/8 12h UN	881393024	302,52
2"	2"1/2 12h UN	881394032	620,23

One piece JIC 37° male

Machos una sola pieza rosca JIC 37°

Außengewinde einteilig JIC 37°

Mâle pré-serti JIC 37°



DN	ROSCA THREAD	Referencia Part n°	€
1/4"	7/16" 20h UNF	881400704	29,02
3/8"	9/16" 18h UNF	881400906	36,73
1/2"	3/4" 16h UNF	881401208	36,95
3/8"	7/8" 14h UNF	NEW 881401406	41,12
1/2"	7/8" 14h UNF	NEW 881401408	34,23
5/8"	7/8" 14h UNF	881401410	45,70
5/8"	1"1/16 12h UN	NEW 881401710	53,59
3/4"	1"1/16 12h UN	881401712	58,19
1"	1"1/16 12h UN	NEW 881401716	81,78
3/4"	1"5/16 12h UN	NEW 881402112	76,93
1"	1"5/16 12h UN	881402116	96,24
1"1/4"	1"5/8 12h UN	881402620	160,90
1"1/2"	1"7/8 12h UN	881403024	199,11
2"	2"1/2 12h UN	881404032	383,46

One piece double hexagonal JIC 37° Swivel female

Hembras giratorias rectas una sola pieza JIC 37°
doble hexagonal

Dichtkopf mit Ü-Mutter einteilig JIC 37° doppelt
6 kt

Femelle pré-sertie JIC 37° double hexagonal



DN	ROSCA THREAD	Referencia Part n°	€
1/4"	7/16" 20h UNF	882420704	27,77
1/4"	1/2" 20h UNF	882420804	32,53
1/4"	9/16" 18h UNF	882420904	35,56
3/8"	9/16" 18h UNF	882420906	31,74
5/16"	1/2" 20h UNF	NEW 882420805	42,10
3/8"	3/4" 16h UNF	882421206	37,85
1/2"	3/4" 16h UNF	882421208	34,10
3/4"	3/4" 16h UNF	882421212	73,45
1/2"	7/8" 14h UNF	882421408	47,38
5/8"	7/8" 14h UNF	882421410	53,47
5/8"	1"1/16 12h UN	882421710	57,87
3/4"	1"1/16 12h UN	882421712	59,82
1"	1"1/16 12h UN	882421716	101,00
3/4"	1"5/16 12h UN	882422112	79,65
1"	1"5/16 12h UN	882422116	96,23
1"1/4"	1"5/8 12h UN	882422620	183,90
1"1/2"	1"7/8 12h UN	882423024	232,47
2"	2"1/2 12h UN	882424032	403,37

ONE PIECE FITTINGS 43 SERIES R1AT/R2AT/1SN/2SN/R16/2SC/R17

Conexiones una sola pieza Serie 43 R1AT/R2AT/1SN/2SN/R16/2SC/R17

Einteilige Armaturen Serie 43 R1AT/R2AT/1SN/2SN/R16/2SC/R17

Embouts pré-sertis R1AT/R2AT/1SN/2SN/R16/2SC/R17 Série 43

One piece double hexagonal ORFS Swivel female

Hembras giratorias rectas una sola pieza ORFS doble hexagonal

Dichtkopf mit ORFS einteilig Ü-Mutter doppelt 6 kt

Femelle pré-sertie ORFS double hexagonal



DN	ROSCA THREAD	Referencia Part n°	€
1/4"	9/16"-18h	889000904	41,77
1/4"	11/16"-16h	889001104	53,20
3/8"	11/16"-16h	889001106	49,92
3/8"	13/16"-16h	889001306	60,19
1/2"	13/16"-16h	889001308	55,46
1/2"	1"-14h	889001608	92,02
5/8"	1"-14h	889001610	77,64
1/2"	1" 3/16-12h	889001908	105,57
5/8"	1" 3/16-12h	NEW 889001910	101,52
3/4"	1" 3/16-12h	889001912	113,06
3/4"	1" 7/16-12h	889002312	129,11
1"	1" 7/16-12h	889002316	129,61
1" 1/4	1" 11/16-12h	889002720	239,49
1" 1/2	2"-12h	889003224	281,37

One piece ORFS Swivel female (45° Elbow)

Hembras giratorias 45° una sola pieza ORFS

Dichtkopf 45° ORFS einteilig

Coude 45° femelle pré-sertie ORFS



DN	ROSCA THREAD	Referencia Part n°	€
1/4"	9/16"-18h	889080904	71,15
1/4"	11/16"-16h	889081104	87,29
3/8"	11/16"-16h	889081106	86,34
3/8"	13/16"-16h	889081306	94,03
1/2"	13/16"-16h	889081308	95,73
1/2"	1"-14h	889081608	135,34
5/8"	1"-14h	889081610	132,61
3/4"	1" 3/16-12h	889081912	159,45
3/4"	1" 7/16-12h	889082312	225,52
1"	1" 7/16-12h	889082316	233,44
1" 1/4	1" 11/16-12h	889082720	338,82
1" 1/2	2"-12h	889083224	868,04

One piece ORFS male

Machos una sola pieza ORFS

Außengewinde ORFS

Mâle pré-serti ORFS



DN	ROSCA THREAD	Referencia Part n°	€
1/4"	9/16"-18h	889120904	48,26
3/8"	11/16"-16h	889121106	49,45
1/2"	13/16"-16h	889121308	58,93
5/8"	1"-14h	889121610	83,18
3/4"	1" 3/16-12h	889121912	106,47
1"	1" 7/16-12h	889122316	154,46
1" 1/4	1" 11/16-12h	889122720	229,28
1" 1/2	2"-12h	889123224	319,36

One piece ORFS Swivel female (90° Elbow)

Hembras giratorias 90° una sola pieza ORFS

Dichtkopf 90° ORFS einteilig

Coude 90° femelle pré-sertie ORFS



DN	ROSCA THREAD	Referencia Part n°	€
1/4"	9/16"-18h	889070904	71,15
1/4"	11/16"-16h	889071104	87,29
3/8"	11/16"-16h	889071106	86,34
3/8"	13/16"-16h	889071306	94,03
1/2"	13/16"-16h	889071308	95,73
1/2"	1"-14h	889071608	135,34
5/8"	1"-14h	889071610	123,90
3/4"	1" 3/16-12h	889071912	159,45
3/4"	1-7/16-12h	889072312	225,52
1"	1" 7/16-12h	889072316	233,44
1" 1/4	1" 11/16-12h	889072720	338,82
1" 1/2	2"-12h	889073224	868,04

ONE PIECE FITTINGS 43 SERIES R1AT/R2AT/1SN/2SN/R16/2SC/R17

Conexiones una sola pieza Serie 43 R1AT/R2AT/1SN/2SN/R16/2SC/R17

Einteilige Armaturen Serie 43 R1AT/R2AT/1SN/2SN/R16/2SC/R17

Embouts pré-sertis R1AT/R2AT/1SN/2SN/R16/2SC/R17 Série 43

One piece NPSM Swivel female 60° cone

Hembras giratorias rectas una sola pieza rosca NPSM cono 60°

Dichtkopf mit NPSM einteilig Ü-Mutter 60° kon.

Femelle pré-sertie NPSM cone 60°



DN	ROSCA THREAD	Referencia Part n°	€
1/4"	1/4" 18h NPSM	882610404	25,39
3/8"	3/8" 18h NPSM	882610606	29,29
1/2"	1/2" 14h NPSM	882610808	35,05
3/4"	3/4" 14h NPSM	882611212	56,76
1"	1" - 11 1/2 h NPSM	882611616	95,67

One piece NPSM Swivel female 60° cone (90° Elbow)

Hembras giratorias 90° una sola pieza rosca NPSM cono 60°

Dichtkopf mit NPSM Ü-Mutter 60° kon. 90° einteilig

Coude 90° femelle pré-sertie NPSM cone 60°



DN	ROSCA THREAD	Referencia Part n°	€
1/4"	1/4" 18h NPSM	882620404	35,69
3/8"	3/8" 18h NPSM	882620606	40,96
1/2"	1/2" 14h NPSM	882620808	49,53
3/4"	3/4" 14h NPSM	882621212	85,59
1"	1" - 11 1/2 h NPSM	882621616	126,43

One piece NPSM Swivel female 60° cone (45° Elbow)

Hembras giratorias 45° una sola pieza rosca NPSM cono 60°

Dichtkopf mit NPSM Ü-Mutter 60° CON. 45° einteilig kon.

Coude 45° femelle pré-sertie NPSM cone 60°



DN	ROSCA THREAD	Referencia Part n°	€
1/4"	1/4" 18h NPSM	882630404	35,69
3/8"	3/8" 18h NPSM	882630606	40,96
1/2"	1/2" 14h NPSM	882630808	63,41
3/4"	3/4" 14h NPSM	882631212	85,60
1"	1" - 11 1/2 h NPSM	882631616	126,43

One piece NPT male pipe straight

Machos una sola pieza rosca cónica NPT

Außengewinde einteilig kon. NPT

Mâle pré-serti NPT



DN	ROSCA THREAD	Referencia Part n°	€
1/4"	1/8" NPT	881610204	30,07
1/4"	1/4" NPT	881610404	23,41
3/8"	1/4" NPT	881610406	35,64
1/4"	3/8" NPT	881610604	31,96
3/8"	3/8" NPT	881610606	27,58
1/2"	3/8" NPT	881610608	40,40
1/4"	1/2" NPT	881610804	45,65
3/8"	1/2" NPT	881610806	42,18
1/2"	1/2" NPT	881610808	33,85
5/8"	1/2" NPT	881610810	43,78
3/4"	1/2" NPT	881610812	59,89
1/2"	3/4" NPT	881611208	52,31
5/8"	3/4" NPT	881611210	51,62
3/4"	3/4" NPT	881611212	52,43
3/4"	1" NPT	881611612	75,89
1"	1" NPT	881611616	87,83
1"1/4"	1"1/4 NPT	881612020	157,80
1"1/2"	1"1/2 NPT	881612424	186,27
2"	2" NPT	881613232	302,24

One piece double hexagonal NPSM Swivel female 60° cone

Hembras giratorias rectas una sola pieza rosca NPSM cono 60° doble hexagonal

Dichtkopf mit NPSM einteilig Ü-Mutter 60° kon. doppelt 6 kt

Femelle pré-sertie NPSM cone 60° double hexagonal



DN	ROSCA THREAD	Referencia Part n°	€
1/4"	1/4" 18h NPSM	883610404	38,46
3/8"	3/8" 18h NPSM	883610606	42,50
1/2"	1/2" 14h NPSM	883610808	46,13
3/4"	3/4" 14h NPSM	883611212	70,91
1"	1" - 11 1/2 h NPSM	883611616	115,74

One piece NPT swivel male

Machos giratorios una sola pieza rosca cónica NPT

Außengewinde einteilig kon. NPT

Mâle tournant pré-serti NPT



DN	ROSCA THREAD	Referencia Part n°	€
1/4"	1/4" NPT	881650404	57,78
3/8"	3/8" NPT	881650606	67,69
3/8"	1/2" NPT	NEW 881650806	85,03
1/2"	1/2" NPT	881650808	73,87
1/2"	3/4" NPT	NEW 881651208	111,01
3/4"	3/4" NPT	881651212	99,65
1"	1" NPT	881651616	153,27

ONE PIECE FITTINGS 43 SERIES R1AT/R2AT/1SN/2SN/R16/2SC/R17

Conexiones una sola pieza Serie 43 R1AT/R2AT/1SN/2SN/R16/2SC/R17

Einteilige Armaturen Serie 43 R1AT/R2AT/1SN/2SN/R16/2SC/R17

Embouts pré-sertis R1AT/R2AT/1SN/2SN/R16/2SC/R17 Série 43

One piece 3000 PSI SAE Straight Flange / Code 61

Bridas rectas una sola pieza SAE 3000 PSI

Gerader Kompaktflansch SAE 3000 PSI

Bride SAE droite pré-sertie série 3000 PSI



DN	Ø	Referencia Part n°	€
1/2"	30.2	881820808	56,76
1/2"	38.1	881821208	94,92
3/4"	38.1	881821212	81,03
3/4"	44.5	881821612	111,81
1"	44.5	881821616	111,76
1"	50.8	881822016	145,92
1"1/4	50.8	881822020	168,38
1"1/4	60.3	881822420	223,78
1"1/2	60.3	881822424	215,68
1"1/2	71.4	881823224	329,61
2"	71.4	881823232	342,71

One piece 3000 PSI SAE Flange (90° Elbow)/ Code 61

Bridas 90° una sola pieza SAE 3000 PSI

Kompaktflansch 90° SAE 3000 PSI

Bride SAE coude 90° pré-sertie série 3000 PSI



DN	Ø	Referencia Part n°	€
1/2"	30.2	881830808	77,18
1/2"	38.1	881831208	96,26
3/4"	38.1	881831212	110,89
3/4"	44.5	881831612	150,56
1"	44.5	881831616	153,44
1"	50.8	881832016	221,37
1"1/4	50.8	881832020	239,83
1"1/4	60.3	881832420	340,43
1"1/2	60.3	881832424	325,64
1"1/2	71.4	881833224	484,80
2"	71.4	881833232	482,80

One piece 3000 PSI SAE Flange (45° Elbow)/ Code 61

Bridas 45° una sola pieza SAE 3000 PSI

Kompaktflansch 45° SAE 3000 PSI

Bride SAE coude 45° pré-sertie série 3000 PSI



DN	Ø	Referencia Part n°	€
1/2"	30.2	881840808	77,18
1/2"	38.1	881841208	96,26
3/4"	38.1	881841212	110,89
3/4"	44.5	881841612	150,56
1"	44.5	881841616	153,44
1"	50.8	881842016	223,69
1"1/4	50.8	881842020	239,83
1"1/4	60.3	881842420	340,43
1"1/2	60.3	881842424	325,64
2"	71.4	881843232	482,80

One piece 6000 PSI SAE Straight Flange / Code 62

Bridas rectas una sola pieza SAE 6000 PSI

Gerader Kompaktflansch SAE 6000 PSI

Bride SAE droite pré-sertie série 6000 PSI



DN	Ø	Referencia Part n°	€
1/2"	31.8	882820808	64,17
3/4"	41.3	882821212	92,68
1"	47.6	882821616	128,77
1"1/4	54	882822020	193,84
1"1/2	63.5	882822424	250,88
2"	79.4	882823232	411,91

One piece 6000 PSI SAE Flange (90° Elbow)/ Code 62

Bridas 90° una sola pieza SAE 6000 PSI

Kompaktflansch 90° SAE 6000 PSI

Bride SAE coude 90° pré-sertie série 6000 PSI



DN	Ø	Referencia Part n°	€
1/2"	31.8	882830808	77,40
3/4"	41.3	882831212	117,72
1"	47.6	882831616	177,07
1"1/4	54	882832020	248,93
1"1/2	63.5	882832424	399,59
2"	79.4	882833232	506,09

One piece 6000 PSI SAE Flange (45° Elbow)/ Code 62

Bridas 45° una sola pieza SAE 6000 PSI

Kompaktflansch 45° SAE 6000 PSI

Bride SAE coude 45° pré-sertie série 6000 PSI



DN	Ø	Referencia Part n°	€
1/2"	31.8	882840808	77,40
3/4"	41.3	882841212	117,80
1"	47.6	882841616	177,07
1"1/4	54	882842020	247,65
1"1/2	63.5	882842424	398,79
2"	79.4	882843232	506,09

ONE PIECE FITTINGS 43 SERIES R1AT/R2AT/1SN/2SN/R16/2SC/R17

Conexiones una sola pieza Serie 43 R1AT/R2AT/1SN/2SN/R16/2SC/R17

Einteilige Armaturen Serie 43 R1AT/R2AT/1SN/2SN/R16/2SC/R17

Emboutis pré-sertis R1AT/R2AT/1SN/2SN/R16/2SC/R17 Série 43

One piece Metric female cone 24°

Hembras giratorias rectas una sola pieza rosca Métrica cono 24° - DKO

Dichtkopf metr. einteilig Ü-Mutter kon. 24°

Femelle pré-sertie Métrique cono 24°



DN	TUBO PIPE	SERIE SERIES	ROSCA THREAD	Referencia Part n°	€
1/4"	6	L	M12x1.5	88804120604	22,89
1/4"	8	L	M14x1.5	88804140804	22,30
1/4"	10	L	M16x1.5	88804161004	23,76
3/8"	10	L	M16x1.5	88804161006	27,93
5/16"	10	L	M16x1.5	88804161005	26,93
1/4"	12	L	M18x1.5	NEW 88804181204	30,75
3/8"	12	L	M18x1.5	88804181206	27,07
1/2"	15	L	M22x1.5	88804221508	32,82
1/2"	18	L	M26x1.5	88804261808	41,95
5/8"	18	L	M26x1.5	88804261810	42,98
3/4"	18	L	M26x1.5	NEW 88804261812	65,64
3/4"	22	L	M30x2	88804302212	55,66
1"	28	L	M36x2	88804362816	93,50
1"1/4	35	L	M45x2	88804453520	150,94
1"1/2	42	L	M52x2	88804524224	192,65
1/4"	8	S	M16x1.5	88804160804	24,83
1/4"	10	S	M18x1.5	88804181004	24,59
1/4"	12	S	M20x1.5	NEW 88804201204	42,60
3/8"	12	S	M20x1.5	88804201206	30,28
1/2"	12	S	M20x1.5	NEW 88804201208	37,21
3/8"	16	S	M24x1.5	88804241606	38,72
1/2"	16	S	M24x1.5	88804241608	32,61
5/8"	20	S	M30x2	88804302010	46,07
3/4"	20	S	M30x2	88804302012	67,28
3/4"	25	S	M36x2	88804362512	74,79
1"	25	S	M36x2	88804362516	105,17
1"	30	S	M42x2	88804423016	114,27
1"1/4	38	S	M52x2	88804523820	184,70
1"1/4	42	L	M52x2	NEW 88804524220	198,32

One piece Metric female cone 24° (90° Elbow)

Hembras giratorias 90° una sola pieza Métricas cono 24° - DKO 90°

Dichtkegel mit Ü-Mutter 90° Bogen einteilig

Coude 90° femelle pré-sertie Métrique cono 24°



DN	TUBO PIPE	SERIE SERIES	ROSCA THREAD	Referencia Part n°	€
1/4"	6	L	M12x1.5	88305120604	33,79
1/4"	8	L	M14x1.5	88305140804	32,38
1/4"	10	L	M16x1.5	88305161004	36,09
5/16"	10	L	M16x1.5	88305161005	43,62
1/4"	12	L	M18x1.5	NEW 88305181204	45,41
3/8"	12	L	M18x1.5	88305181206	39,74
1/2"	15	L	M22x1.5	88305221508	47,05
5/8"	18	L	M26x1.5	88305261810	64,42
3/4"	22	L	M30x2	88305302212	80,52
1"	28	L	M36x2	88305362816	129,57
1"1/4	35	L	M45x2	88305453520	228,47
1"1/2	42	L	M52x2	88305524224	317,66
1/4"	8	S	M16x1.5	88305160804	37,00
1/4"	10	S	M18x1.5	88305181004	37,41
1/4"	12	S	M20x1.5	NEW 88305201204	46,39
5/16"	12	S	M20x1.5	88305201205	51,98
3/8"	12	S	M20x1.5	88305201206	44,96
1/2"	16	S	M24x1.5	88305241608	49,86
5/8"	20	S	M30x2	88305302010	74,20
3/4"	20	S	M30x2	88305302012	83,87
3/4"	25	S	M36x2	88305362512	104,20
1"	25	S	M36x2	88305362516	140,44
1"	30	S	M42x2	88305423016	165,49
1"1/4	38	S	M52x2	88305523820	280,75

One piece Metric female cone 24° (45° Elbow)

Hembras giratorias 45° una sola pieza Métricas cono 24° - DKO 45°

Dichtkegel mit Ü-Mutter 45° Bogen einteilig

Coude 45° femelle pré-sertie Métrique cono 24°



DN	TUBO PIPE	SERIE	ROSCA THREAD	Referencia Part n°	€
1/4"	6	L	M12x1.5	88306120604	33,79
1/4"	8	L	M14x1.5	88306140804	32,38
1/4"	10	L	M16x1.5	88306161004	36,09
5/16"	10	L	M16x1.5	88306161005	43,62
3/8"	10	L	M16x1.5	88306161006	42,40
3/8"	12	L	M18x1.5	88306181206	39,96
1/2"	15	L	M22x1.5	88306221508	45,87
1/2"	18	L	M26x1.5	88306261808	65,74
5/8"	18	L	M26x1.5	88306261810	64,88
3/4"	22	L	M30x2	88306302212	80,52
1"	28	L	M36x2	88306362816	129,57
1"1/4	35	L	M45x2	88306453520	212,01
1"1/2	42	L	M52x2	88306524224	316,33
1/4"	8	S	M16x1.5	88306160804	37,00
1/4"	12	S	M20x1.5	NEW 88306201204	46,39
3/8"	10	S	M18x1.5	NEW 88306181006	69,53
3/8"	12	S	M20x1.5	88306201206	42,33
3/8"	14	S	M22x1.5	NEW 88306221406	53,51
1/2"	16	S	M24x1.5	88306241608	46,66
5/8"	20	S	M30x2	88306302010	74,20
3/4"	20	S	M30x2	88306302012	83,87
3/4"	25	S	M36x2	88306362512	104,20
1"	25	S	M36x2	88306362516	140,44
1"	30	S	M42x2	88306423016	164,37
1"1/4	38	S	M52x2	88306523820	280,75

One piece Metric male cone 24°

Machos una sola pieza rosca Métrica cono 24°

Außengewinde einteilig metr. kon. 24°

Mâle pré-serti Métrique cono 24°



DN	TUBO PIPE	SERIE	ROSCA THREAD	Referencia Part n°	€
1/4"	6	L	M12x1.5	88203120604	31,71
1/4"	8	L	M14x1.5	88203140804	25,35
5/16"	10	L	M16x1.5	88203161005	35,79
3/8"	10	L	M16x1.5	88203161006	34,01
3/8"	12	L	M18x1.5	88203181206	25,92
1/2"	15	L	M22x1.5	88203221508	32,85
1/2"	18	L	M26x1.5	NEW 88203261808	43,59
5/8"	18	L	M26x1.5	88203261810	45,16
3/4"	22	L	M30x2	88203302212	60,64
1"	28	L	M36x2	88203362816	94,85
1"1/4	35	L	M45x2	88203453520	154,77
1"1/2	42	L	M52x2	88203524224	217,67
1/4"	8	S	M16x1.5	88203160804	31,03
1/4"	10	S	M18x1.5	88203181004	35,52
3/8"	12	S	M20x1.5	88203201206	36,78
1/2"	16	S	M24x1.5	88203241608	35,88
5/8"	20	S	M30x2	88203302010	55,79
3/4"	20	S	M30x2	88203302012	64,36
1"	25	S	M36x2	88203362516	113,38
1"	30	S	M42x2	88203423016	127,99
1"1/4	38	S	M52x2	88203523820	201,42

ONE PIECE FITTINGS 43 SERIES R1AT/R2AT/1SN/2SN/R16/2SC/R17

Conexiones una sola pieza Serie 43 R1AT/R2AT/1SN/2SN/R16/2SC/R17

Einteilige Armaturen Serie 43 R1AT/R2AT/1SN/2SN/R16/2SC/R17

Embouts pré-sertis R1AT/R2AT/1SN/2SN/R16/2SC/R17 Série 43

One piece BSP female 60° cone

Hembras giratorias rectas una sola pieza rosca BSP cono 60°

Dichtkopf mit Ü-Mutter einteilig BSP 60° kon.

Femelle pré-sertie BSP cone 60°



DN	ROSCA THREAD	Referencia Part n°	€
1/4"	1/4" BSP	881000404	21,14
1/4"	3/8" BSP	881000604	25,95
5/16"	3/8" BSP	881000605	28,51
3/8"	3/8" BSP	881000606	26,46
1/2"	3/8" BSP	881000608	29,72
3/8"	1/2" BSP	881000806	30,62
1/2"	1/2" BSP	881000808	29,95
5/8"	1/2" BSP	881000810	43,74
5/8"	5/8" BSP	881001010	48,94
1/2"	3/4" BSP	881001208	42,89
5/8"	3/4" BSP	881001210	43,39
3/4"	3/4" BSP	881001212	49,86
3/4"	1" BSP	881001612	66,35
1"	1" BSP	881001616	82,44
1"1/4"	1"1/4 BSP	881002020	151,93
1"1/2"	1"1/2 BSP	881002424	181,70
2"	2" BSP	881003232	297,21

One piece BSP female cone 60° (90° Elbow)

Hembras giratorias 90° una sola pieza rosca BSP cono 60°

Dichtkopf BSP Ü-Mutter einteilig 60° kon. 90°

Coude 90° femelle pré-sertie BSP cone 60°



DN	ROSCA THREAD	Referencia Part n°	€
1/4"	1/4" BSP	881070404	30,74
1/4"	3/8" BSP	NEW 881070604	39,25
3/8"	3/8" BSP	881070606	36,30
1/2"	3/8" BSP	881070608	67,29
3/8"	1/2" BSP	881070806	51,76
1/2"	1/2" BSP	881070808	43,23
5/8"	5/8" BSP	881071010	70,24
5/8"	3/4" BSP	881071210	73,79
3/4"	3/4" BSP	881071212	72,68
3/4"	1" BSP	881071612	95,86
1"	1" BSP	881071616	114,46
1"1/4"	1"1/4 BSP	881072020	217,82
1"1/2"	1"1/2 BSP	881072424	283,21
2"	2" BSP	881073232	495,18

One piece BSP female cone 60° (45° Elbow)

Hembras giratorias 45° una sola pieza rosca BSP cono 60°

Dichtkopf mit BSP Ü-Mutter 60° einteilig 45° kon.

Coude 45° femelle pré-sertie BSP cone 60°



DN	ROSCA THREAD	Referencia Part n°	€
1/4"	1/4" BSP	881080404	30,75
3/8"	3/8" BSP	881080606	36,98
3/8"	1/2" BSP	NEW 881080806	48,01
1/2"	1/2" BSP	881080808	43,23
3/4"	3/4" BSP	881081212	72,68
1"	1" BSP	881081616	114,46
1"1/4"	1"1/4 BSP	881082020	204,45
1"1/2"	1"1/2 BSP	881082424	283,21
2"	2" BSP	881083232	495,18

One piece BSP male 60° cone

Machos una sola pieza rosca cilíndrica BSP cono 60°

Außengewinde zyl. einteilig kon. BSP 60°

Mâle pré-serti BSP cone 60°



DN	ROSCA THREAD	Referencia Part n°	€
1/4"	1/4" BSP	881120404	24,97
3/8"	3/8" BSP	881120606	28,23
3/8"	1/2" BSP	881120806	35,22
1/2"	1/2" BSP	881120808	33,42
3/4"	3/4" BSP	881121212	53,43
3/4"	1" BSP	881121612	81,36
1"	1" BSP	881121616	98,65
1"1/4"	1"1/4 BSP	881122020	166,54
1"1/2"	1"1/2 BSP	881122424	202,28
2"	2" BSP	881123232	311,15

One piece double hexagonal BSP female 60° cone

Hembras giratorias rectas una sola pieza rosca BSP cono 60° doble hexagonal

Dichtkopf mit Ü-Mutter einteilig BSP 60° kon. doppelt 6 kt

Femelle pré-sertie BSP cone 60° double hexagonal



DN	ROSCA THREAD	Referencia Part n°	€
1/4"	1/4" BSP	884000404	32,82
5/16"	3/8" BSP	884000605	40,54
3/8"	3/8" BSP	884000606	36,66
1/2"	1/2" BSP	884000808	39,82
3/4"	3/4" BSP	884001212	66,00
1"	1" BSP	884001616	107,93
1"1/4"	1"1/4 BSP	884002020	162,48
1"1/2"	1"1/2 BSP	884002424	226,81
2"	2" BSP	884003232	368,17

One piece BSP female flat seat

Hembras giratorias rectas compactas rosca BSP asiento plano

Dichtkopf mit Ü-Mutter einteilig BSP flachdichtend

Femelle pré-sertie BSP fond plat



DN	ROSCA THREAD	Referencia Part n°	€
1/4"	1/4" BSP	882000404	25,01
3/8"	3/8" BSP	882000606	27,91
1/2"	1/2" BSP	882000808	34,35
3/4"	3/4" BSP	882001212	55,25
1"	1" BSP	882001616	85,61

ONE PIECE FITTINGS BWS SERIES 3SP/4SP/R12/4SH NO SKIVE

Conexiones una sola pieza Serie BWS 3SP/4SP/R12/4SH No Pelar
Einteilige Armaturen Serie BWS 3SP/4SP/R12/4SH ohne Schälung
Embouts pré-serti Série BWS 3SP/4SP/R12/4SH Sans dénuder

R13 & R15 Ø 3/4" - 1"

One piece JIC 37° male



Machos una sola pieza rosca JIC 37°

Außengewinde einteilig JIC 37°

Mâle pré-serti JIC 37°



DN	ROSCA THREAD	Referencia Part n°	€
3/8"	9/16" 18h UNF	Z581400906	41,43
1/2"	3/4" 16h UNF	Z581401208	41,68
5/8"	7/8" 14h UNF	Z581401410	51,55
3/4"	1"1/16 12h UN	Z581401712	65,64
1"	1"5/16 12h UN	Z581402116	108,57
1"1/4	1"5/8 12h UN	Z581402620	181,51
1"1/2	1"7/8 12 UN	Z581403024	224,61
2"	2"1/2 12h UN	Z581404032	432,58

One piece JIC 37° Swivel female (45° Elbow)



Hembras giratorias 45° una sola pieza JIC 37°

Dichtkopf JIC 37° einteilig 45°

Coude 45° femelle pré-sertie JIC 37°



DN	ROSCA THREAD	Referencia Part n°	€
3/8"	9/16" 18h UNF	Z581390906	47,09
1/2"	3/4" 16h UNF	Z581391208	48,91
5/8"	7/8" 14h UNF	Z581391410	71,24
3/4"	1"1/16 12h UN	Z581391712	84,57
1"	1"5/16 12h UN	Z581392116	134,81
1"1/4	1"5/8 12h UN	Z581392620	235,78
1"1/2	1"7/8 12 UN	Z581393024	341,27
2"	2"1/2 12h UN	Z581394032	699,68

One piece JIC 37° Swivel female



Hembras giratorias rectas una sola pieza JIC 37°

Dichtkopf mit Ü-Mutter einteilig JIC 37°

Femelle pré-sertie JIC 37°



DN	ROSCA THREAD	Referencia Part n°	€
3/8"	9/16" 18h UNF	Z581420906	31,20
1/2"	3/4" 16h UNF	Z581421208	35,68
5/8"	7/8" 14h UNF	Z581421410	45,76
3/4"	1"1/16 12h UN	Z581421712	56,64
1"	1"5/16 12h UN	Z581422116	95,30
1"1/4	1"5/8 12h UN	Z581422620	170,22
1"1/2	1"7/8 12 UN	Z581423024	220,72
2"	2"1/2 12h UN	Z581424032	381,21

One piece double hexagonal JIC 37° Swivel female

Hembras giratorias rectas una sola pieza JIC 37°
doble hexagonal

Dichtkopf mit Ü-Mutter einteilig JIC 37° doppelt
6 kt

Femelle pré-sertie JIC 37° double hexagonal



DN	ROSCA THREAD	Referencia Part n°	€
3/8"	9/16" 18h UNF	Z582420906	35,80
1/2"	3/4" 16h UNF	Z582421208	38,47
5/8"	7/8" 14h UNF	Z582421408	51,12
3/4"	1"1/16 12h UN	Z582421712	60,32
1"	1"5/16 12h UN	Z582422116	108,56
1"1/4	1"5/8 12h UN	Z582422620	207,46
1"1/2	1"7/8 12 UN	Z582423024	262,24
2"	2"1/2 12h UN	Z582424032	455,04

One piece JIC 37° Swivel female (90° Elbow)



Hembras giratorias 90° una sola pieza JIC 37°

Dichtkopf einteilig Ü-Mutter 37° JIC 90°

Coude 90° femelle pré-sertie JIC 37°



DN	ROSCA THREAD	Referencia Part n°	€
3/8"	9/16" 18h UNF	Z581380906	45,36
1/2"	3/4" 16h UNF	Z581381208	51,79
5/8"	7/8" 14h UNF	Z581381410	67,75
3/4"	1"1/16 12h UN	Z581381712	84,58
1"	1"5/16 12h UN	Z581382116	134,81
1"1/4	1"5/8 12h UN	Z581382620	235,78
1"1/2	1"7/8 12 UN	Z581383024	355,65
2"	2"1/2 12h UN	Z581384032	699,68

ONE PIECE FITTINGS BWS SERIES 3SP/4SP/R12/4SH NO SKIVE

Conexiones una sola pieza Serie BWS 3SP/4SP/R12/4SH No Pelar
Einteilige Armaturen Serie BWS 3SP/4SP/R12/4SH ohne Schälung
Embouts pré-sertis Série BWS 3SP/4SP/R12/4SH Sans dénuder

R13 & R15 Ø 3/4" - 1"

NEW

One piece double hexagonal ORFS Swivel female

Hembras giratorias rectas una sola pieza ORFS
doble hexagonal

Dichtkopf mit ORFS einteilig Ü-Mutter doppelt 6 kt

Femelle pré-sertie ORFS double hexagonal



DN	ROSCA THREAD	Referencia Part n°	€
3/8"	11/16" 16h UN	Z589001106	54,81
1/2"	13/16" 16h UN	Z589001308	60,69
5/8"	1" 14h UNS	Z589001610	87,58
3/4"	1"3/16 12h UN	Z589001912	98,96
1"	1"7/16 12h UN	Z589002316	146,21
1"1/4	1"11/16 12h UN	Z589002720	270,16
1"1/2	2" 12h UN	Z589003224	317,41

One piece ORFS Swivel female (45° Elbow)

Hembras giratorias 45° una sola pieza ORFS

Dichtkopf 45° ORFS einteilig

Coude 45° femelle pré-sertie ORFS



DN	ROSCA THREAD	Referencia Part n°	€
3/8"	11/16" 16h UN	Z589081106	94,67
1/2"	13/16" 16h UN	Z589081308	107,99
5/8"	1" 14h UNS	Z589081610	149,59
3/4"	1"3/16 12h UN	Z589081912	174,25
1"	1"7/16 12h UN	Z589082316	260,22
1"1/4	1"11/16 12h UN	Z589082720	382,22
1"1/2	2" 12h UN	Z589083224	958,24

NEW

One piece ORFS Swivel female (90° Elbow)

Hembras giratorias 90° una sola pieza ORFS

Dichtkopf 90° ORFS einteilig

Coude 90° femelle pré-sertie ORFS



DN	ROSCA THREAD	Referencia Part n°	€
3/8"	11/16" 16h UN	Z589071106	94,67
1/2"	13/16" 16h UN	Z589071308	107,99
5/8"	1" 14h UNS	Z589071610	136,27
3/4"	1"3/16 12h UN	Z589071912	174,25
1"	1"7/16 12h UN	Z589072316	260,22
1"1/4	1"11/16 12h UN	Z589072720	382,22
1"1/2	2" 12h UN	Z589073224	958,24

NEW

One piece ORFS male

Machos una sola pieza ORFS

Außengewinde ORFS

Mâle pré-serti ORFS



DN	ROSCA THREAD	Referencia Part n°	€
3/8"	11/16" 16h UN	Z589121106	55,78
1/2"	13/16" 16h UN	Z589121308	66,47
5/8"	1" 14h UNS	Z589121610	93,83
3/4"	1"3/16 12h UN	Z589121912	120,11
1"	1"7/16 12h UN	Z589122316	174,25
1"1/4	1"11/16 12h UN	Z589122720	258,66
1"1/2	2" 12h UN	Z589123224	360,27

NEW

ONE PIECE FITTINGS BWS SERIES 3SP/4SP/R12/4SH NO SKIVE

Conexiones una sola pieza Serie BWS 3SP/4SP/R12/4SH No Pelar
Einteilige Armaturen Serie BWS 3SP/4SP/R12/4SH ohne Schälung
Embouts pré-sertis Série BWS 3SP/4SP/R12/4SH Sans dénuder

R13 & R15 Ø 3/4" - 1"

One piece NPSM Swivel female 60° cone



Hembras giratorias rectas una sola pieza NPSM cono 60°

Dichtkopf mit NPSM einteilig Ü-Mutter 60° kon.

Femelle pré-sertie NPSM cone 60°



DN	ROSCA THREAD	Referencia Part n°	€
3/8"	3/8" NPSM	Z582610606	33,04
1/2"	1/2" NPSM	Z582610808	39,54
3/4"	3/4" NPSM	Z582611212	64,03
1"	1" NPSM	Z582611616	107,93
1"1/4	1"1/4 NPSM	Z582612020	184,43
1"1/2	1"1/2 NPSM	Z582612424	216,48
2"	2" NPSM	Z582613232	356,69

One piece double hexagonal NPSM Swivel female 60° cone



Hembras giratorias rectas una sola pieza rosca NPSM cono 60° doble hexagonal

Dichtkopf mit NPSM einteilig Ü-Mutter 60° kon. doppelt 6 kt

Femelle pré-sertie NPSM cone 60° double hexagonal



DN	ROSCA THREAD	Referencia Part n°	€
3/8"	3/8" NPSM	Z583610606	47,94
1/2"	1/2" NPSM	Z583610808	52,04
3/4"	3/4" NPSM	Z583611212	79,99
1"	1" NPSM	Z583611616	130,57

One piece NPSM Swivel female 60° cone (90° Elbow)



Hembras giratorias 90° una sola pieza rosca NPSM cono 60°

Dichtkopf mit NPSM Ü-Mutter 60° kon. 90° einteilig

Coûde 90° femelle pré-sertie NPSM cone 60°



DN	ROSCA THREAD	Referencia Part n°	€
3/8"	3/8" NPSM	Z582620606	46,21
1/2"	1/2" NPSM	Z582620808	55,88
3/4"	3/4" NPSM	Z582621212	96,56
1"	1" NPSM	Z582621616	142,63

One piece NPSM Swivel female 60° cone (45° Elbow)



Hembras giratorias 45° una sola pieza rosca NPSM cono 60°

Dichtkopf mit NPSM Ü-Mutter 60° CON. 45° einteilig kon.

Coûde 45° femelle pré-sertie NPSM cone 60°



DN	ROSCA THREAD	Referencia Part n°	€
3/8"	3/8" NPSM	Z582630606	46,20
1/2"	1/2" NPSM	Z582630808	71,54
3/4"	3/4" NPSM	Z582631212	96,56
1"	1" NPSM	Z582631616	142,63

One piece NPT male pipe straight



Machos una sola pieza rosca cónica NPT

Außengewinde einteilig kon. NPT

Mâle pré-serti NPT



DN	ROSCA THREAD	Referencia Part n°	€
3/8"	3/8" NPT	Z581610606	30,46
1/2"	1/2" NPT	Z581610808	37,17
3/4"	3/4" NPT	Z581611212	59,15
1"	1" NPT	Z581611616	99,08
1"1/4	1"1/4 NPT	Z581612020	178,01
1"1/2	1"1/2 NPT	Z581612424	210,13
2"	2" NPT	Z581613232	340,96

ONE PIECE FITTINGS BWS SERIES 3SP/4SP/R12/4SH NO SKIVE

Conexiones una sola pieza Serie BWS 3SP/4SP/R12/4SH No Pelar
Einteilige Armaturen Serie BWS 3SP/4SP/R12/4SH ohne Schälung
Embouts pré-sertis Série BWS 3SP/4SP/R12/4SH Sans dénuder

R13 & R15 Ø 3/4" - 1"

One piece 3000 PSI SAE Straight Flange / Code 61



Bridas rectas una sola pieza SAE 3000 PSI

Gerader Kompaktflansch SAE 3000 PSI

Bride SAE droite pré-sertie série 3000 PSI



DN	Ø	Referencia Part n°	€
1/2"	30.2	Z581820808	64,03
5/8"	38.1	Z581821210	88,58
3/4"	38.1	Z581821212	91,41
1"	44.5	Z581821612	126,13
1"	44.5	Z581821616	126,08
1"1/4	50.8	Z581822020	189,95
1"1/2	60.3	Z581822424	243,31
2"	71.4	Z581823232	386,60

One piece 3000 PSI SAE Flange (90° Elbow)/ Code 61



Bridas 90° una sola pieza SAE 3000 PSI

Kompaktflansch 90° SAE 3000 PSI

Bride SAE coude 90° pré-sertie série 3000 PSI



DN	Ø	Referencia Part n°	€
1/2"	30.2	Z581830808	87,06
5/8"	38.1	Z581831210	127,96
3/4"	38.1	Z581831212	125,10
1"	44.5	Z581831616	173,09
1"1/4	50.8	Z581832020	270,56
1"1/4	60.3	Z581832420	380,54
1"1/2	60.3	Z581832424	366,23
2"	71.4	Z581833232	544,64

One piece 3000 PSI SAE Flange (45° Elbow)/ Code 61



Bridas 45° una sola pieza SAE 3000 PSI

Kompaktflansch 45° SAE 3000 PSI

Bride SAE coude 45° pré-sertie série 3000 PSI



DN	Ø	Referencia Part n°	€
1/2"	30.2	Z581840808	87,06
5/8"	38.1	Z581841210	127,96
3/4"	38.1	Z581841212	125,10
1"	44.5	Z581841616	173,09
1"1/4	50.8	Z581842020	270,56
1"1/2	60.3	Z581842424	366,23
2"	71.4	Z581843232	544,64

One piece 6000 PSI SAE Straight Flange / Code 62



Bridas rectas una sola pieza SAE 6000 PSI

Gerader Kompaktflansch SAE 6000 PSI

Bride SAE droite pré-sertie série 6000 PSI



DN	Ø	Referencia Part n°	€
1/2"	31.8	Z582820808	72,38
5/8"	41.3	Z582821210	116,19
3/4"	41.3	Z582821212	104,56
1"	47.6	Z582821616	145,27
1"1/4	54.0	Z582822020	218,67
1"1/2	63.5	Z582822424	283,01
2"	79.4	Z582823232	464,68

One piece 6000 PSI SAE Flange (90° Elbow)/ Code 62



Bridas 90° una sola pieza SAE 6000 PSI

Kompaktflansch 90° SAE 6000 PSI

Bride SAE coude 90° pré-sertie série 6000 PSI



DN	Ø	Referencia Part n°	€
1/2"	31.8	Z582830808	87,31
5/8"	41.3	Z582831210	141,47
3/4"	41.3	Z582831212	132,79
1"	47.6	Z582831616	199,75
1"1/4	54.0	Z582832020	280,82
1"1/2	63.5	Z582832424	450,77
2"	79.4	Z582833232	570,92

One piece 6000 PSI SAE Flange (45° Elbow)/ Code 62



Bridas 45° una sola pieza SAE 6000 PSI

Kompaktflansch 45° SAE 6000 PSI

Bride SAE coude 45° pré-sertie série 6000 PSI



DN	Ø	Referencia Part n°	€
1/2"	31.8	Z582840808	87,31
5/8"	41.3	Z582841210	141,47
3/4"	41.3	Z582841212	132,88
1"	47.6	Z582841616	199,75
1"1/4	54.0	Z582842020	279,37
1"1/2	63.5	Z582842424	449,87
2"	79.4	Z582843232	570,92

ONE PIECE FITTINGS BWS SERIES 3SP/4SP/R12/4SH NO SKIVE

Conexiones una sola pieza Serie BWS 3SP/4SP/R12/4SH No Pelar
Einteilige Armaturen Serie BWS 3SP/4SP/R12/4SH ohne Schälung
Embouts pré-sertis Série BWS 3SP/4SP/R12/4SH Sans dénuder

R13 & R15 Ø 3/4" - 1"

One piece Metric female cone 24°



Hembras giratorias rectas una sola pieza rosca Métrica cono 24° - DKO

Dichtkopf metr. einteilig Ü-Mutter kon. 24°

Femelle pré-sertie Métrique cone 24°



DN	TUBO	SERIE	ROSCA THREAD	Referencia Part n°	€
3/8"	10	L	M16x1.5	Z58804161006	31,51
3/8"	12	L	M18x1.5	Z58804181206	30,54
3/8"	15	L	M22x1.5	Z58804221506	37,18
1/2"	15	L	M22x1.5	Z58804221508	37,03
1/2"	18	L	M26x1.5	Z58804261808	47,32
5/8"	18	L	M26x1.5	Z58804261810	48,49
3/4"	22	L	M30x2	Z58804302212	62,79
1"	28	L	M36x2	Z58804362816	105,48
1"1/4	35	L	M45x2	Z58804453520	170,28
1"1/2	42	L	M52x2	Z58804524224	217,33
3/8"	12	S	M20x1.5	Z58804201206	34,16
1/2"	16	S	M24x1.5	Z58804241608	36,79
5/8"	20	S	M30x2	Z58804302010	51,97
3/4"	20	S	M30x2	Z58804302012	75,90
3/4"	25	S	M36x2	Z58804362512	84,37
1"	30	S	M42x2	Z58804423016	128,90
1"1/4	38	S	M45x2	Z58804523820	208,36

One piece Metric female cone 24° (90° Elbow)



Hembras giratorias 90° una sola pieza Métricas cono 24° - DKO 90°

Dichtkegel mit Ü-Mutter 90° Bogen einteilig

Coude 90° femelle pré-sertie Métrique cone 24°



DN	TUBO	ROSCA	SERIE SERIES	Referencia Part n°	€
3/8"	10	M16x1.5	L	Z58305161006	47,17
3/8"	12	M18x1.5	L	Z58305181206	44,83
1/2"	15	M22x1.5	L	Z58305221508	53,07
5/8"	18	M26x1.5	L	Z58305261810	72,68
3/4"	22	M30x2	L	Z58305302212	90,84
1"	28	M36x2	L	Z58305362816	146,17
1"1/4	35	M45x2	L	Z58305453520	257,73
1"1/2	42	M52x2	L	Z58305524224	358,35
3/8"	12	M20x1.5	S	Z58305201206	50,71
1/2"	16	M24x1.5	S	Z58305241608	56,25
5/8"	20	M30x2	S	Z58305302010	83,71
3/4"	20	M30x2	S	Z58305302012	94,62
3/4"	25	M36x2	S	Z58305362512	117,55
1"	30	M42x2	S	Z58305423016	186,69
1"1/4	38	M45x2	S	Z58305523820	316,71

One piece Metric female cone 24° (45° Elbow)



Hembras giratorias 45° una sola pieza Métricas cono 24° - DKO 45°

Dichtkegel mit Ü-Mutter 45° Bogen einteilig

Coude 45° femelle pré-sertie Métrique cone 24°



DN	TUBO PIPE	SERIE	ROSCA THREAD	Referencia Part n°	€
3/8"	10	L	M16x1.5	Z58306161006	47,83
3/8"	12	L	M18x1.5	Z58306181206	45,08
1/2"	15	L	M22x1.5	Z58306221508	51,74
5/8"	18	L	M26x1.5	Z58306261810	73,20
3/4"	22	L	M30x2	Z58306302212	90,84
1"	28	L	M36x2	Z58306362816	146,17
1"1/4	35	L	M45x2	Z58306453520	239,17
1"1/2	42	L	M52x2	Z58306524224	356,85
3/8"	12	S	M20x1.5	Z58306201206	47,75
1/2"	16	S	M24x1.5	Z58306241608	52,64
5/8"	20	S	M30x2	Z58306302010	83,71
3/4"	20	S	M30x2	Z58306302012	94,62
3/4"	25	S	M36x2	Z58306362512	117,55
1"	30	S	M42x2	Z58306423016	185,43
1"1/4	38	S	M45x2	Z58306523820	316,71

One piece Metric male cone 24°



Machos una sola pieza rosca Métrica cono 24°

Außengewinde einteilig metr. kon. 24°

Mâle pré-serti Métrique cone 24°



DN	TUBO PIPE	SERIE	ROSCA THREAD	Referencia Part n°	€
3/8"	10	L	M16x1.5	Z58203161006	38,37
3/8"	12	L	M18x1.5	Z58203181206	29,24
3/8"	15	L	M22x1.5	Z58203221506	41,65
1/2"	15	L	M22x1.5	Z58203221508	37,06
1/2"	18	L	M26x1.5	Z58203261808	49,17
5/8"	18	L	M26x1.5	Z58203261810	50,94
3/4"	22	L	M30x2	Z58203302212	68,41
1"	28	L	M36x2	Z58203362816	107,00
1"1/4	35	L	M45x2	Z58203453520	174,60
1"1/2	42	L	M52x2	Z58203524224	245,55
3/8"	12	S	M20x1.5	Z58203201206	41,49
1/2"	16	S	M24x1.5	Z58203241608	40,47
5/8"	20	S	M30x2	Z58203302010	62,93
3/4"	20	S	M30x2	Z58203302012	72,60
3/4"	25	S	M36x2	Z58203362512	90,77
1"	30	S	M42x2	Z58203423016	144,39
1"1/4	38	S	M45x2	Z58203523820	227,22

ONE PIECE FITTINGS BWS SERIES 3SP/4SP/R12/4SH NO SKIVE

Conexiones una sola pieza Serie BWS 3SP/4SP/R12/4SH No Pelar
Einteilige Armaturen Serie BWS 3SP/4SP/R12/4SH ohne Schälung
Embouts pré-sertis Série BWS 3SP/4SP/R12/4SH Sans dénuder

R13 & R15 Ø 3/4" - 1"

One piece BSP female 60° cone 60° w/o ring

NEW

Hembras giratorias rectas una sola pieza BSP C/J
cono 60°

Dichtkopf mit Ü-Mutter einteilig BSP 60° mit
O'Ring kon.

Femelle pré-sertie BSP cone 60° avec joint



DN MANGUERA DN HOSE	ROSCA THREAD	Referencia Part n°	€
3/8"	3/8" BSP	Z581100606	32,69
1/2"	1/2" BSP	Z581100808	36,58
3/4"	3/4" BSP	Z581101212	56,63
1"	1" BSP	Z581101616	100,79
1"1/4	1"1/4 BSP	Z581102020	173,01
1"1/2	1"1/2 BSP	Z581102424	222,45
2"	2" BSP	Z581103232	376,67

One piece BSP female cone 60° w/o ring (90° Elbow)

NEW

Hembras giratorias 90° una sola pieza BSP C/J
cono 60°

Dichtkopf BSP Ü-Mutter einteilig 60° mit
O'Ringkon. 90°

Coude 90° femelle pré-sertie BSP cone 60° avec
joint



DN	R1	Referencia Part n°	€
3/8"	3/8" BSP	Z581170606	53,07
1/2"	1/2" BSP	Z581170808	58,88
3/4"	3/4" BSP	Z581171212	88,57
1"	1" BSP	Z581171616	145,10
1"1/4	1"1/4 BSP	Z581172020	267,48
1"1/2	1"1/2 BSP	Z581172424	351,22
2"	2" BSP	Z581173232	648,70

One piece BSP female cone 60° w/o ring (45° Elbow)

NEW

Hembras giratorias 45° una sola pieza BSP C/J
cono 60°

Dichtkopf mit BSP Ü-Mutter 60° mit O'Ring
einteilig 45° kon.

Coude 45° femelle pré-sertie BSP cone 60° avec
joint



DN	R1	Referencia Part n°	€
3/8"	3/8" BSP	Z581180606	53,07
1/2"	1/2" BSP	Z581180808	58,88
3/4"	3/4" BSP	Z581181212	88,57
1"	1" BSP	Z581181616	145,10
1"1/4	1"1/4 BSP	Z581182020	267,48
1"1/2	1"1/2 BSP	Z581182424	351,22
2"	2" BSP	Z581183232	648,70

One piece BSP male 60° cone

NEW

Machos una sola pieza rosca cilíndrica BSP cono
60°

Außengewinde zyl. einteilig kon. BSP 60°

Mâle pré-serti BSP cone 60°



DN	ROSCA THREAD	Referencia Part n°	€
3/8"	3/8" BSP	Z581120606	31,85
1/2"	1/2" BSP	Z581120808	37,70
5/8"	5/8" BSP	Z581121010	61,03
3/4"	3/4" BSP	Z581121212	60,28
1"	1" BSP	Z581121616	109,15
1"1/4	1"1/4 BSP	Z581122020	187,87
1"1/2	1"1/2 BSP	Z581122424	228,19
2"	2" BSP	Z581123232	351,01

One piece double hexagonal BSP female 60° cone

NEW

Hembras giratorias rectas una sola pieza BSP cono
60° doble hexagonal

Dichtkopf mit Ü-Mutter einteilig BSP 60° kon.
doppelt 6 kt

Femelle pré-sertie BSP cone 60° double hexagonal



DN	ROSCA THREAD	Referencia Part n°	€
3/8"	3/8" BSP	Z584000606	41,36
1/2"	1/2" BSP	Z584000808	44,92
3/4"	3/4" BSP	Z584001212	74,46
1"	1" BSP	Z584001616	121,75
1"1/4	1"1/4 BSP	Z584002020	183,29
1"1/2	1"1/2 BSP	Z584002424	255,87
2"	2" BSP	Z584003232	415,33

One piece BSP female flat seat

NEW

Hembras giratorias rectas una sola pieza BSP
asiento plano

Dichtkopf mit Ü-Mutter einteilig BSP flachdichtend

Femelle pré-sertie BSP fond plat



DN	ROSCA THREAD	Referencia Part n°	€
3/8"	3/8" BSP	Z582000606	31,49
1/2"	1/2" BSP	Z582000808	35,62
3/4"	3/4" BSP	Z582001212	57,01
1"	1" BSP	Z582001616	96,57
1"1/4	1"1/4 BSP	Z582002020	174,79
1"1/2	1"1/2 BSP	Z582002424	212,74
2"	2" BSP	Z582003232	354,15

ONE PIECE FITTINGS R7/R8 & ELASTOMER BRAID OF STEEL WIRE

Conexiones una sola pieza R7/ R8/ Elastómero malla metálica
Einteilige Armaturen R7/ R8 und Elastomer/Metallumfl.
Embouts pré-sertis R7/R8 et Elastomère tresse métallique

One piece JIC 37° female

Hembras giratorias rectas una sola pieza rosca JIC 37°

Dichtkopf einteilig Ü-Mutter 37° JIC

Femelle pré-sertie JIC 37°



DN	ROSCA THREAD	Referencia Part n°	€
3/16"	7/16" 20h UNF	871420703	22,42
1/4"	7/16" 20h UNF	871420704	20,68
1/4"	9/16" 18h UNF	871420904	23,39
5/16"	9/16" 18h UNF	871420905	23,54
3/8"	9/16" 18h UNF	871420906	24,25
1/2"	3/4" 16h UNF	871421208	28,95
1/2"	7/8" 14h UNF	871421408	30,82
3/4"	1"1/16 12h UN	871421712	42,74
1"	1"5/16 12h UN	871422116	71,22

One piece JIC 37° female (90° Elbow)

Hembras giratorias 90° una sola pieza rosca JIC 37°

Dichtkopf einteilig Ü-Mutter 37° JIC 90°

90° Femelle pré-sertie JIC 37°



DN	ROSCA THREAD	Referencia Part n°	€
3/16"	7/16" 20h UNF	871380703	36,55
1/4"	7/16" 20h UNF	871380704	30,01
1/4"	9/16" 18h UNF	871380904	44,72
3/8"	9/16" 18h UNF	871380906	36,68
1/2"	3/4" 16h UNF	871381208	43,10
3/4"	1"1/16 12h UN	871381712	67,27
1"	1"5/16 12h UN	871382116	105,92

One piece JIC 37° female (45° Elbow)

Hembras giratorias 45° una sola pieza rosca JIC 37°

Dichtkopf einteilig Ü-Mutter 37° JIC 45°

45° Femelle pré-sertie JIC 37°



DN	ROSCA THREAD	Referencia Part n°	€
1/4"	7/16" 20h UNF	871390704	31,08
3/8"	9/16" 18h UNF	871390906	38,20
1/2"	3/4" 16h UNF	871391208	40,57
3/4"	1"1/16 12h UN	871391712	67,27
1"	1"5/16 12h UN	871392116	105,91

One piece JIC 37° male

Machos una sola pieza rosca JIC 37°

Außengewinde einteilig JIC 37°

Mâle pré-serti JIC 37°



DN	ROSCA THREAD	Referencia Part n°	€
1/4"	7/16" 20h UNF	871400704	27,20
3/8"	9/16" 18h UNF	871400906	33,23
1/2"	3/4" 16h UNF	871401208	34,23
3/4"	1"1/16 12h UN	871401712	50,65
1"	1"5/16 12h UN	871402116	82,87

One piece double hexagonal JIC 37° female

Hembras giratorias rectas una sola pieza rosca JIC 37° doble hexagonal

Dichtkopf einteilig Ü-Mutter 37° JIC doppelt 6 kt

Femelle pré-sertie JIC 37° double hexagonal



DN	ROSCA THREAD	Referencia Part n°	€
3/16"	7/16" 20h UNF	872420703	26,46
1/4"	7/16" 20h UNF	872420704	25,11
5/16"	7/16" 20h UNF	872420705	37,00
5/16"	9/16" 18h UNF	NEW 872420905	37,46
3/8"	9/16" 18h UNF	872420906	28,29
1/2"	3/4" 16h UNF	872421208	31,40
1/2"	7/8" 14h UNF	872421408	44,92
5/8"	1"1/16 12h UN	NEW 872421710	59,53
3/4"	1"1/16 12h UN	872421712	52,26
1"	1"5/16 12h UN	872422116	82,87

ONE PIECE FITTINGS R7/R8 & ELASTOMER BRAID OF STEEL WIRE

Conexiones una sola pieza R7/ R8/ Elastómero malla metálica

Einteilige Armaturen R7/ R8 und Elastomer/Metallumfl.

Embouts pré-sertis R7/R8 et Elastomère tresse métallique

One piece double hexagonal ORFS female

Hembras giratorias rectas una sola pieza rosca ORFS doble hexagonal

Dichtkopf mit ORFS einteilig Ü-Mutter doppelt 6 kt

Femelle pré-sertie ORFS double hexagonal



DN	ROSCA THREAD	Referencia Part n°	€
1/4"	9/16"-18h	879000904	39,82
3/8"	11/16"-16h	879001106	45,94
3/8"	13/16"-16h	NEW 879001306	54,64
1/2"	13/16"-16h	879001308	51,85
3/4"	1"3/16-12h	879001912	105,00
1"	1"7/16-12h	879002316	115,93

One piece ORFS female (90° Elbow)

Hembras giratorias 90° una sola pieza rosca ORFS

Dichtkopf mit ORFS einteilig Ü-Mutter 90°

90° Femelle pré-sertie ORFS



DN	ROSCA THREAD	Referencia Part n°	€
1/4"	9/16"-18h	879070904	68,55
3/8"	11/16"-16h	879071106	82,01
1/2"	13/16"-16h	879071308	92,44
3/4"	1"3/16-12h	879071912	150,95
1"	1"7/16-12h	879072316	221,85

One piece ORFS female (45° Elbow)

Hembras giratorias 45° una sola pieza rosca ORFS

Dichtkopf 45° ORFS einteilig

45° Femelle pré-sertie ORFS



DN	ROSCA THREAD	Referencia Part n°	€
1/4"	9/16"-18h	879080904	68,55
3/8"	11/16"-16h	879081106	82,01
1/2"	13/16"-16h	879081308	92,44
3/4"	1"3/16-12h	879081912	150,95
1"	1"7/16-12h	879082316	221,85

One piece ORFS male

Machos compactos rosca ORFS

Außengewinde einteilig ORFS

Mâle pré-serti ORFS



DN	ROSCA THREAD	Referencia Part n°	€
1/4"	9/16"-18h	879120904	46,25
3/8"	11/16"-16h	879121106	45,83
1/2"	13/16"-16h	879121308	55,99
3/4"	1"3/16-12h	879121912	98,47
1"	1"7/16-12h	879122316	143,23

ONE PIECE FITTINGS R7/R8 & ELASTOMER BRAID OF STEEL WIRE

Conexiones una sola pieza R7/ R8/ Elastómero malla metálica
Einteilige Armaturen R7/ R8 und Elastomer/Metallumfl.
Embouts pré-sertis R7/R8 et Elastomère tresse métallique

One piece NPSM female 60° cone

Hembras giratorias rectas una sola pieza rosca NPSM cono 60°

Dichtkopf mit NPSM einteilig Ü-Mutter 60° kon.

Femelle pré-sertie NPSM cone 60°



DN	ROSCA THREAD	Referencia Part n°	€
1/4"	1/4" 18h NPSM	872610404	23,60
3/8"	3/8" 18h NPSM	872610606	25,86
1/2"	1/2" 14h NPSM	872610808	32,34
3/4"	3/4" 14h NPSM	872611212	49,23
1"	1" - 11 1/2 h NPSM	872611616	82,32

One piece NPSM female 60° cone (90° Elbow)

Hembras giratorias 90° una sola pieza rosca NPSM cono 60°

Dichtkopf mit NPSM einteilig Ü-Mutter 60° kon. 90°

90° Femelle pré-sertie NPSM cone 60°



DN	ROSCA THREAD	Referencia Part n°	€
1/4"	1/4" 18h NPSM	872620404	33,80
3/8"	3/8" 18h NPSM	872620606	37,42
1/2"	1/2" 14h NPSM	872620808	46,69
3/4"	3/4" 14h NPSM	872621212	77,79
1"	1" - 11 1/2 h NPSM	872621616	112,78

One piece NPSM female 60° cone (45° Elbow)

Hembras giratorias 45° una sola pieza rosca NPSM cono 60°

Dichtkopf mit NPSM Ü-Mutter 60° kon. 45° einteilig

45° Femelle pré-sertie NPSM cone 60°



DN	ROSCA THREAD	Referencia Part n°	€
1/4"	1/4" 18h NPSM	872630404	33,80
3/8"	3/8" 18h NPSM	872630606	37,42
1/2"	1/2" 14h NPSM	872630808	60,44
3/4"	3/4" 14h NPSM	872631212	77,79
1"	1" - 11 1/2 h NPSM	872631616	112,78

One piece NPT male pipe straight

Machos una sola pieza rosca cónica NPT

Außengewinde einteilig kon. NPT

Mâle pré-serti NPT



DN	ROSCA THREAD	Referencia Part n°	€
3/16"	1/4" NPT	871610403	26,77
1/4"	1/4" NPT	871610404	21,38
3/8"	1/4" NPT	NEW 871610406	32,15
1/4"	3/8" NPT	NEW 871610604	30,11
3/8"	3/8" NPT	871610606	23,60
1/2"	1/2" NPT	871610808	30,26
3/4"	3/4" NPT	871611212	44,94
1"	1" NPT	871611616	74,55

One piece double hexagonal NPSM female 60° cone

Hembras giratorias rectas una sola pieza rosca NPSM cono 60° doble hexagonal

Dichtkopf mit NPSM einteilig Ü-Mutter 60° kon. doppelt 6 kt

Femelle pré-sertie NPSM cone 60° double hexagonal



DN	ROSCA THREAD	Referencia Part n°	€
1/4"	1/4" NPSM	873610404	36,55
3/8"	3/8" 18h NPSM	873610606	38,95
1/2"	1/2" 14h NPSM	873610808	43,31
3/4"	3/4" NPSM	873611212	63,24
1"	1" - 11 1/2 h NPSM	873611616	102,19

ONE PIECE FITTINGS R7/R8 & ELASTOMER BRAID OF STEEL WIRE

Conexiones una sola pieza R7/ R8/ Elastómero malla metálica

Einteilige Armaturen R7/ R8 und Elastomer/Metallumfl.

Embouts pré-sertis R7/R8 et Elastomère tresse métallique

One piece Metric female 24° cone

Hembras giratorias rectas una sola pieza rosca Métrica cono 24° - DKO

Dichtkopf metr. einteilig Ü-Mutter kon. 24°

Femelle pré-sertie Métrique cono 24°



DN	TUBO PIPE	SERIE SERIES	ROSCA THREAD		Referencia Part n°	€
3/16"	6	L	M12x1.5	NEW	87804120603	22,44
1/4"	6	L	M12x1.5	NEW	87804120604	21,10
1/4"	8	L	M14x1.5		87804140804	20,22
3/8"	12	L	M18x1.5		87804181206	23,67
1/2"	15	L	M22x1.5		87804221508	30,14
3/4"	22	L	M30x2		87804302212	48,14
1"	28	L	M36x2		87804362816	80,16
1/4"	8	S	M16x1.5		87804160804	23,05
1/4"	10	S	M18x1.5		87804181004	22,80
3/8"	12	S	M20x1.5		87804201206	26,85
1/2"	16	S	M24x1.5		87804241608	29,93
3/4"	20	S	M30x2		87804302012	59,65
3/4"	25	S	M36x2		87804362512	67,09
1"	30	S	M42x2		87804423016	100,73

One piece Metric male 24° cone

Machos una sola pieza rosca Métrica cono 24°

Außengewinde einteilig metr. kon. 24°

Mâle pré-serti Métrique cono 24°



DN	TUBO PIPE	SERIE SERIES	ROSCA THREAD		Referencia Part n°	€
1/4"	8	L	M14x1.5		87203140804	23,56
3/8"	12	L	M18x1.5		87203181206	22,53
1/2"	15	L	M22x1.5		87203221508	30,16
3/4"	22	L	M30x2		87203302212	53,07
1"	28	L	M36x2		87203362816	81,50
1/4"	8	S	M16x1.5		87203160804	29,18
1/4"	10	S	M18x1.5	NEW	87203181004	33,64
3/8"	12	S	M20x1.5		87203201206	33,28
1/2"	16	S	M24x1.5		87203241608	33,16
3/4"	25	S	M36x2		87203362512	72,71
1"	30	S	M42x2		87203423016	114,33

One piece Metric female 24° cone (90° Elbow)

Hembras giratorias 90° una sola pieza Métricas cono 24° - DKO 90°

Dichtkegel mit Ü-Mutter 90° Bogen einteilig

90° Femelle pré-sertie Métrique cono 24°



DN	TUBO PIPE	SERIE SERIES	ROSCA THREAD		Referencia Part n°	€
1/4"	8	L	M14x1.5		87305140804	30,52
3/8"	12	L	M18x1.5		87305181206	36,21
1/2"	15	L	M22x1.5		87305221508	44,22
3/4"	22	L	M30x2		87305302212	72,77
1"	28	L	M36x2		87305362816	115,89
1/4"	8	S	M16x1.5		87305160804	35,10
1/4"	10	S	M18x1.5		87305181004	35,50
3/8"	12	S	M20x1.5		87305201206	41,38
1/2"	16	S	M24x1.5		87305241608	47,02
3/4"	25	S	M36x2		87305362512	96,22
1"	30	S	M42x2		87305423016	151,47

One piece Metric female 24° cone (45° Elbow)

Hembras giratorias 45° una sola pieza Métricas cono 24° - DKO 45°

Dichtkegel mit Ü-Mutter 45° Bogen einteilig

45° Femelle pré-sertie Métrique cono 24°



DN	TUBO PIPE	SERIE SERIES	ROSCA THREAD		Referencia Part n°	€
1/4"	8	L	M14x1.5		87306140804	30,52
3/8"	10	L	M16x1.5	NEW	87306161006	38,85
3/8"	12	L	M18x1.5		87306181206	36,44
1/2"	15	L	M22x1.5		87306221508	43,06
3/4"	22	L	M30x2		87306302212	72,77
1"	28	L	M36x2		87306362816	115,89
1/4"	8	S	M16x1.5		87306160804	35,10
1/4"	10	S	M18x1.5		87306181004	35,51
3/8"	12	S	M20x1.5		87306201206	38,78
1/2"	16	S	M24x1.5		87306241608	43,84
3/4"	25	S	M36x2		87306362512	96,22
1"	30	S	M42x2		87306423016	150,36

ONE PIECE FITTINGS R7/R8 & ELASTOMER BRAID OF STEEL WIRE

Conexiones una sola pieza R7/ R8/ Elastómero malla metálica
Einteilige Armaturen R7/ R8 und Elastomer/Metallumfl.
Embouts pré-sertis R7/R8 et Elastomère tresse métallique

One piece BSP female 60° cone

Hembras giratorias rectas una sola pieza rosca BSP cono 60°

Dichtkopf mit Ü-Mutter einteilig BSP 60° kon.

Femelle pré-sertie BSP cone 60°



DN	ROSCA THREAD		Referencia Part n°	€
3/16"	1/4" BSP	NEW	871000403	20,88
1/4"	1/4" BSP		871000404	19,39
3/8"	3/8" BSP		871000606	23,06
1/2"	1/2" BSP		871000808	27,29
3/4"	3/4" BSP		871001212	42,39
1"	1" BSP		871001616	69,20

One piece BSP female 60° cone (90° Elbow)

Hembras giratorias 90° una sola pieza rosca BSP cono 60°

Dichtkopf mit BSP einteilig Ü-Mutter 60° kon. 90°

90° Femelle pré-sertie BSP cone 60°



DN	ROSCA THREAD		Referencia Part n°	€
1/4"	1/4" BSP		871070404	28,90
1/4"	3/8" BSP	NEW	871070604	37,33
3/8"	3/8" BSP		871070606	32,81
1/2"	1/2" BSP		871070808	40,44
3/4"	3/4" BSP		871071212	65,00
1"	1" BSP		871071616	100,92

One piece BSP female 60° cone (45° Elbow)

Hembras giratorias 45° una sola pieza rosca BSP cono 60°

Dichtkopf mit BSP Ü-Mutter 60° einteilig kon. 45°

45° Femelle pré-sertie BSP cone 60°



DN	ROSCA THREAD		Referencia Part n°	€
1/4"	1/4" BSP		871080404	28,90
3/8"	3/8" BSP		871080606	33,48
1/2"	1/2" BSP		871080808	40,45
3/4"	3/4" BSP		871081212	65,00
1"	1" BSP		871081616	100,92

One piece BSP male 60° cone

Machos una sola pieza rosca cilíndrica BSP cono 60°

Außengewinde zyl. einteilig kon. BSP 60°

Mâle pré-serti BSP cone 60°



DN	ROSCA THREAD		Referencia Part n°	€
1/4"	1/4" BSP		871120404	23,18
3/8"	3/8" BSP		871120606	24,81
1/2"	1/2" BSP		871120808	30,73
3/4"	3/4" BSP		871121212	45,94
1"	1" BSP		871121616	83,74

One piece double hexagonal BSP female 60° cone

Hembras giratorias rectas una sola pieza rosca BSP cono 60° doble hexagonal

Dichtkopf mit Ü-Mutter einteilig BSP 60° kon. doppelt 6 kt

Femelle pré-sertie BSP cone 60° double hexagonal



DN	ROSCA THREAD		Referencia Part n°	€
1/4"	1/4" BSP		874000404	30,95
3/8"	3/8" BSP		874000606	33,17
1/2"	1/2" BSP		874000808	37,06
3/4"	3/4" BSP		874001212	58,39
1"	1" BSP		874001616	94,45

ONE PIECE FITTINGS FOR SMOOTH PTFE/ R14

Conexiones una sola pieza PTFE Liso / R14
Einteilige Armaturen PTFE-Glattschlauch/ R14
Embouts pré-sertis pour PTFE lisse/ R14

One piece JIC 37° female

Hembras giratorias rectas una sola pieza rosca JIC 37°

Dichtkopf einteilig Ü-Mutter 37° JIC

Femelle pré-sertie JIC 37°



DN	ROSCA THREAD	Referencia Part n°	€
1/4"	7/16" 20h UNF	861420704	18,74
3/16"	7/16" 20h UNF	861420703	22,82
1/4"	1/2" 20h UNF	861420804	19,97
5/16"	1/2" 20h UNF	861420805	23,15
5/16"	9/16" 18h UNF	861420905	22,14
3/8"	9/16" 18h UNF	861420906	21,99
3/8"	3/4" 16h UNF	861421206	24,97
1/2"	3/4" 16h UNF	861421208	26,25
3/4"	1"1/16 12h UN	861421712	39,50
1"	1"5/16 12h UN	861422116	65,78

One piece JIC 37° female (90° Elbow)

Hembras giratorias 90° una sola pieza rosca JIC 37°

Dichtkopf einteilig Ü-Mutter 37° JIC 90°

90° Femelle pré-sertie JIC 37°



DN	ROSCA THREAD	Referencia Part n°	€
3/16"	7/16" 20h UNF	861380703	36,94
1/4"	7/16" 20h UNF	861380704	28,08
5/16"	9/16" 18h UNF	861380905	36,20
3/8"	9/16" 18h UNF	861380906	34,42
1/2"	3/4" 16h UNF	861381208	40,39
1/2"	7/8" 14UNF	861381408	43,10
5/8"	7/8" 14UNF	861381410	59,16
3/4"	1"1/16 12h UN	861381712	64,02
1"	1"5/16 12h UN	861382116	100,48

One piece JIC 37° female (45° Elbow)

Hembras giratorias 45° una sola pieza rosca JIC 37°

Dichtkopf einteilig Ü-Mutter 37° JIC 45°

45° Femelle pré-sertie JIC 37°



DN	ROSCA THREAD	Referencia Part n°	€
1/4"	7/16" 20h UNF	861390704	29,15
5/16"	9/16" 18h UNF	861390905	36,21
3/8"	9/16" 18h UNF	861390906	35,94
1/2"	3/4" 16h UNF	861391208	37,87
3/4"	1"1/16 12h UN	861391712	64,02
1"	1"5/16 12h UN	861392116	100,47

One piece JIC 37° male

Machos una sola pieza rosca JIC 37°

Außengewinde einteilig JIC 37°

Mâle pré-serti JIC 37°



DN	ROSCA THREAD	Referencia Part n°	€
1/4"	7/16" 20h UNF	861400704	25,26
3/8"	9/16" 18h UNF	861400906	30,98
1/2"	3/4" 16h UNF	861401208	31,52
5/8"	1"1/16 12h UN	861401710	52,75
3/4"	1"1/16 12h UN	861401712	47,40
1"	1"5/16 12h UN	861402116	77,43

One piece JIC 37° double hexagonal female

Hembras giratorias rectas una sola pieza rosca JIC 37° doble hexagonal

Dichtkopf einteilig Ü-Mutter 37° JIC doppelt 6 kt

Femelle pré-sertie JIC 37° double hexagonal



DN	ROSCA THREAD	Referencia Part n°	€
3/16"	7/16" 20h UNF	862420703	26,86
1/4"	7/16" 20h UNF	862420704	23,17
1/4"	1/2" 20h UNF	862420804	28,74
5/16"	1/2" 20h UNF	862420805	36,37
5/16"	9/16" 18h UNF	862420905	36,05
3/8"	9/16" 18h UNF	862420906	26,03
3/8"	3/4" 16h UNF	862421206	32,09
1/2"	3/4" 16h UNF	862421208	28,70
5/8"	3/4" 16h UNF	862421210	45,19
1/2"	3/4" 16h UNF	862421408	41,85
5/8"	3/4" 16h UNF	862421410	52,64
1/2"	1"1/16 12h UN	862421708	47,67
5/8"	1"1/16 12h UN	862421710	57,00
3/4"	1"1/16 12h UN	862421712	49,01
1"	1"1/16 12h UN	862421716	82,15
3/4"	1"5/16 12h UN	862422112	68,66
1"	1"5/16 12h UN	862422116	77,41

ONE PIECE FITTINGS FOR SMOOTH PTFE/ R14

Conexiones una sola pieza PTFE Liso / R14
Einteilige Armaturen PTFE-Glattschlauch/ R14
Embouts pré-sertis pour PTFE lisse/ R14

One piece doble hexagonal ORFS female

Hembras giratorias rectas una sola pieza rosca ORFS doble hexagonal

Dichtkopf mit ORFS einteilig Ü-Mutter doppelt 6 kt

Femelle pré-sertie ORFS double hexagonal



DN	ROSCA THREAD	Referencia Part n°	€
1/4"	9/16"-18h	869000904	37,89
5/16"	11/16"-16h	869001105	48,24
3/8"	11/16"-16h	869001106	44,13
1/2"	13/16"-16h	869001308	49,86
3/4"	1"3/16-12h	869001912	101,88
1"	1"7/16-12h	869002316	110,47

One piece ORFS female (90° Elbow)

Hembras giratorias 90° una sola pieza rosca ORFS

Dichtkopf mit ORFS einteilig Ü-Mutter 90°

90° Femelle pré-sertie ORFS



DN	ROSCA THREAD	Referencia Part n°	€
1/4"	9/16"-18h	869070904	66,99
3/8"	11/16"-16h	869071106	80,20
1/2"	13/16"-16h	869071308	89,74
3/4"	1"3/16-12h	869071912	147,27
1"	1"7/16-12h	869072316	218,32

One piece ORFS female (45° Elbow)

Hembras giratorias 45° una sola pieza rosca ORFS

Dichtkopf mit ORFS einteilig Ü-Mutter 45°

45° Femelle pré-sertie ORFS



DN	ROSCA THREAD	Referencia Part n°	€
1/4"	9/16"-18h	869080904	66,99
3/8"	11/16"-16h	869081106	80,20
1/2"	13/16"-16h	869081308	89,74
3/4"	1"3/16-12h	869081912	147,27
1"	1"7/16-12h	869082316	218,32

One piece ORFS male

Machos una sola pieza rosca ORFS

Außengewinde einteilig ORFS

Mâle pré-serti ORFS



DN	ROSCA THREAD	Referencia Part n°	€
1/4"	9/16"-18h	869120904	44,31
3/8"	11/16"-16h	869121106	43,57
1/2"	13/16"-16h	869121308	53,29
3/4"	1"3/16-12h	869121912	95,22
1"	1"7/16-12h	869122316	139,69

ONE PIECE FITTINGS FOR SMOOTH PTFE / R14

Conexiones una sola pieza PTFE Liso / R14
Einteilige Armaturen PTFE-Glattschlauch / R14
Embouts pré-sertis pour PTFE lisse / R14

One piece NPSM female 60° cone

Hembras giratorias rectas una sola pieza rosca NPSM cono 60°

Dichtkopf mit NPSM einteilig Ü-Mutter 60° kon.

Femelle pré-sertie NPSM cone 60°



DN	ROSCA THREAD	Referencia Part n°	€
1/4"	1/4" 18h NPSM	862610404	21,66
3/8"	3/8" 18h NPSM	862610606	23,61
1/2"	1/2" 14h NPSM	862610808	29,64
3/4"	3/4" 14h NPSM	862611212	45,99
1"	1" - 11 1/2 h NPSM	862611616	75,53

One piece NPSM female 60° cone (90° Elbow)

Hembras giratorias 90° una sola pieza rosca NPSM cono 60°

Dichtkopf mit NPSM einteilig Ü-Mutter 60° kon. 90°

90° Femelle pré-sertie NPSM cone 60°



DN	ROSCA THREAD	Referencia Part n°	€
1/4"	1/4" 18h NPSM	862620404	31,87
3/8"	3/8" 18h NPSM	862620606	35,17
1/2"	1/2" 14h NPSM	862620808	43,99
3/4"	3/4" 14h NPSM	862621212	74,54
1"	1" - 11 1/2 h NPSM	862621616	106,00

One piece NPSM female 60° cone (45° Elbow)

Hembras giratorias 45° una sola pieza rosca NPSM cono 60°

Dichtkopf mit NPSM einteilig Ü-Mutter 60° kon. 45°

45° Femelle pré-sertie NPSM cone 60°



DN	ROSCA THREAD	Referencia Part n°	€
1/4"	1/4" 18h NPSM	862630404	31,87
3/8"	3/8" 18h NPSM	862630606	35,16
1/2"	1/2" 14h NPSM	862630808	57,74
3/4"	3/4" 14h NPSM	862631212	74,55
1"	1" - 11 1/2 h NPSM	862631616	106,00

One piece NPT male pipe

Machos una sola pieza rosca cónica NPT

Außengewinde einteilig kon. NPT

Mâle pré-serti NPT



DN	ROSCA THREAD	Referencia Part n°	€
1/4"	1/8" NPT	NEW 861610204	26,30
3/16"	1/4" NPT	NEW 861610403	26,39
1/4"	1/4" NPT	861610404	19,44
5/16"	1/4" NPT	NEW 861610405	30,00
3/8"	1/4" NPT	NEW 861610406	29,90
1/4"	3/8" NPT	NEW 861610604	28,17
5/16"	3/8" NPT	NEW 861610605	32,68
3/8"	3/8" NPT	861610606	21,34
1/2"	1/2" NPT	NEW 861610608	34,94
3/8"	1/2" NPT	NEW 861610806	36,37
1/2"	1/2" NPT	861610808	27,56
5/8"	1/2" NPT	NEW 861610810	43,04
1/2"	3/4" NPT	NEW 861611208	46,74
5/8"	3/4" NPT	NEW 861611210	50,81
3/4"	3/4" NPT	861611212	41,70
3/4"	1" NPT	NEW 861611612	64,93
1"	1" NPT	861611616	67,76
1"	1" 1/4 NPT	NEW 861612016	110,44

One piece double hexagonal NPSM female 60° cone

Hembras giratorias rectas una sola pieza rosca NPSM cono 60° doble hexagonal

Dichtkopf mit NPSM einteilig Ü-Mutter 60° kon. doppelt 6 kt

Femelle pré-sertie NPSM cone 60° double hexagonal



DN	ROSCA THREAD	Referencia Part n°	€
1/4"	1/4" NPSM	863610404	34,61
3/8"	3/8" 18h NPSM	863610606	36,69
1/2"	1/2" 14h NPSM	863610808	40,61
3/4"	3/4" NPSM	863611212	60,00
1"	1" - 11 1/2 h NPSM	863611616	96,75

ONE PIECE FITTINGS FOR SMOOTH PTFE/ R14

Conexiones una sola pieza PTFE Liso / R14
Einteilige Armaturen PTFE-Glattschlauch/ R14
Embouts pré-sertis pour PTFE lisse/ R14

One piece Metric female 24° cone

Hembras giratorias rectas una sola pieza rosca
Métrica cono 24° - DKO

Dichtkopf metr. einteilig Ü-Mutter kon. 24°

Femelle pré-sertie Métrique cone 24°



DN	TUBO PIPE	SERIE SERIES	ROSCA THREAD	Referencia Part n°	€
1/4"	8	L	M14x1.5	86804140804	18,28
3/8"	12	L	M18x1.5	86804181206	21,41
1/2"	15	L	M22x1.5	86804221508	27,44
3/4"	22	L	M30x2	86804302212	44,90
1"	28	L	M36x2	86804362816	73,38
1/4"	8	S	M16x1.5	86804160804	21,11
3/8"	12	S	M20x1.5	86804201206	24,59
1/2"	16	S	M24x1.5	86804241608	27,22
3/4"	25	S	M36x2	86804362512	63,84
1"	30	S	M42x2	86804423016	93,94

One piece Metric female 24° cone (90° Elbow)

Hembras giratorias 90° una sola pieza rosca
Métrica cono 24° - DKO 90°

Dichtkopf 90° metr. einteilig Ü-Mutter kon. 24°

90° Femelle pré-sertie Métrique cone 24°



DN	TUBO PIPE	SERIE SERIES	ROSCA THREAD	Referencia Part n°	€
1/4"	8	L	M14x1.5	86305140804	28,59
3/8"	12	L	M18x1.5	86305181206	33,96
1/2"	15	L	M22x1.5	86305221508	41,52
3/4"	22	L	M30x2	86305302212	69,52
1"	28	L	M36x2	86305362816	109,11
1/4"	8	S	M16x1.5	86305160804	33,17
3/8"	12	S	M20x1.5	86305201206	39,12
1/2"	16	S	M24x1.5	86305241608	44,31
3/4"	25	S	M36x2	86305362512	92,98
1"	30	S	M42x2	86305423016	144,68

One piece Metric female 24° cone (45° Elbow)

Hembras giratorias 45° una sola pieza rosca
Métrica cono 24° - DKO 45°

Dichtkopf 45° metr. einteilig Ü-Mutter kon. 24°

45° Femelle pré-sertie Métrique cone 24°



DN	TUBO PIPE	ROSCA THREAD	SERIE SERIES	Referencia Part n°	€
1/4"	8	M14x1.5	L	86306140804	28,59
3/8"	12	M18x1.5	L	86306181206	34,18
1/2"	15	M22x1.5	L	86306221508	40,35
3/4"	22	M30x2	L	86306302212	69,52
1"	28	M36x2	L	86306362816	109,11
1/4"	8	M16x1.5	S	86306160804	33,17
3/8"	12	M20x1.5	S	86306201206	36,52
1/2"	16	M24x1.5	S	86306241608	41,14
3/4"	25	M36x2	S	86306362512	92,98
1"	30	M42x2	S	86306423016	143,58

One piece Metric male 24° cone

Machos compactos rosca Métrica cono 24°

Außengewinde einteilig metr. kon. 24°

Mâle pré-serti Métrique cone 24°



DN	TUBO PIPE	SERIE SERIES	ROSCA THREAD	Referencia Part n°	€
1/4"	8	L	M14x1.5	86203140804	21,62
3/8"	12	L	M18x1.5	86203181206	20,27
1/2"	15	L	M22x1.5	86203221508	27,46
3/4"	22	L	M30x2	86203302212	49,83
1"	28	L	M36x2	86203362816	75,69
1/4"	8	S	M16x1.5	86203160804	27,25
3/8"	12	S	M20x1.5	86203201206	31,03
1/2"	16	S	M24x1.5	86203241608	30,46
3/4"	25	S	M36x2	86203362512	69,46
1"	30	S	M42x2	86203423016	107,54

ONE PIECE FITTINGS FOR SMOOTH PTFE/ R14

Conexiones una sola pieza PTFE Liso / R14
Einteilige Armaturen PTFE-Glattschlauch/ R14
Embouts pré-sertis pour PTFE lisse/ R14

One piece BSP female 60° cone

Hembras giratorias rectas una sola pieza rosca BSP cono 60°

Dichtkopf mit Ü-Mutter einteilig BSP 60° kon.

Femelle pré-sertie BSP cono 60°



DN	ROSCA THREAD	Referencia Part n°	€
3/16"	1/4" BSP	861000403	21,28
1/4"	1/4" BSP	861000404	17,46
3/8"	3/8" BSP	861000606	20,80
1/2"	1/2" BSP	861000808	24,59
3/4"	3/4" BSP	861001212	39,15
1"	1" BSP	861001616	63,76

One piece BSP female 60° cone (90° Elbow)

Hembras giratorias 90° una sola pieza rosca BSP cono 60°

Dichtkopf mit Ü-Mutter einteilig BSP 60° kon. 90°

90° Femelle pré-sertie BSP cono 60°



DN	ROSCA THREAD	Referencia Part n°	€
1/4"	1/4" BSP	861070404	26,97
3/8"	3/8" BSP	861070606	30,56
1/2"	1/2" BSP	861070808	37,74
3/4"	3/4" BSP	861071212	61,76
1"	1" BSP	861071616	94,61

One piece BSP female 60° cone (45° Elbow)

Hembras giratorias 45° una sola pieza rosca BSP cono 60°

Dichtkopf mit Überwurfmutter einteilig BSP 60° kon. 45°

45° Femelle pré-sertie BSP cono 60°



DN	ROSCA THREAD	Referencia Part n°	€
1/4"	1/4" BSP	861080404	26,97
3/8"	3/8" BSP	861080606	31,22
1/2"	1/2" BSP	861080808	37,74
3/4"	3/4" BSP	861081212	61,75
1"	1" BSP	861081616	94,61

One piece BSP male 60° cone

Machos una sola pieza rosca cilíndrica BSP cono 60°

Außengewinde zyl. einteilig kon. BSP 60°

Mâle pré-serti BSP cono 60°



DN	ROSCA THREAD	Referencia Part n°	€
1/4"	1/4" BSP	861120404	21,25
3/8"	3/8" BSP	861120606	22,56
1/2"	1/2" BSP	861120808	28,03
3/4"	3/4" BSP	861121212	42,69
1"	1" BSP	861121616	80,20

One piece double hexagonal BSP female 60° cone

Hembras giratorias rectas una sola pieza rosca BSP cono 60° doble hexagonal

Dichtkopf mit Überwurfmutter einteilig BSP 60° kon. doppelt 6 kt

Femelle pré-sertie BSP cono 60° double hexagonal



DN	ROSCA THREAD	Referencia Part n°	€
1/4"	1/4" BSP	864000404	29,02
3/8"	3/8" BSP	864000606	30,91
1/2"	1/2" BSP	864000808	34,36
3/4"	3/4" BSP	864001212	55,14
1"	1" BSP	864001616	89,01

ONE PIECE FITTINGS FOR CONVOLUTED PTFE

Conexiones una sola pieza PTFE Corrugado
Einteilige Armaturen PTFE-Wellenschlauch
Embouts pré-sertis pour PTFE convoluté

One piece JIC 37° female

Hembras giratorias rectas una sola pieza rosca JIC 37°

Dichtkopf einteilig Ü-Mutter 37° JIC

Femelle pré-sertie JIC 37°



DN	ROSCA THREAD	Referencia Part n°	€
1/4"	7/16" 20h UNF	851420704	19,98
5/16"	1/2" 20h UNF	851420805	21,84
3/8"	9/16" 18h UNF	851420906	22,21
1/2"	3/4" 16h UNF	851421208	28,17
3/4"	1"1/16 12h UN	851421712	42,77
1"	1"5/16 12h UN	851422116	69,19
1"1/4	1"5/8 12h UN	851422620	117,31
1"1/2	1"7/8 12h UN	NEW 851423024	162,61
2"	2"1/2 12h UN	NEW 851424032	298,29

One piece JIC 37° male

Machos una sola pieza rosca JIC 37°

Außengewinde einteilig JIC 37°

Mâle pré-serti JIC 37°



DN	ROSCA THREAD	Referencia Part n°	€
1/4"	7/16" 20h UNF	851400704	26,50
3/8"	9/16" 18h UNF	851400906	31,19
1/2"	3/4" 16h UNF	851401208	33,45
5/8"	1"1/16 12h UN	NEW 851401710	50,56
3/4"	1"1/16 12h UN	851401712	50,67
1"	1"5/16 12h UN	851402116	80,85
1"1/4	1"5/8 12h UN	NEW 851402620	127,23
1"1/2	1"7/8 12h UN	NEW 851403024	166,03
2"	2"1/2 12h UN	NEW 851404032	343,38

One piece JIC 37° female (90° Elbow)

Hembras giratorias 90° una sola pieza rosca JIC 37°

Dichtkopf einteilig Ü-Mutter 37° JIC 90°

90° Femelle pré-sertie JIC 37°



DN	ROSCA THREAD	Referencia Part n°	€
1/4"	7/16" 20h UNF	851380704	29,32
3/8"	9/16" 18h UNF	851380906	34,64
1/2"	3/4" 16h UNF	851381208	42,32
3/4"	1"1/16 12h UN	851381712	67,29
1"	1"5/16 12h UN	851382116	103,89
1"1/4	1"5/8 12h UN	NEW 851382620	174,91
1"1/2	1"7/8 12h UN	NEW 851383024	281,08
2"	2"1/2 12h UN	NEW 851384032	577,91

One piece JIC 37° double hexagonal female

Hembras giratorias rectas una sola pieza rosca JIC 37° doble hexagonal

Dichtkopf einteilig Ü-Mutter 37° JIC doppelt 6 kt

Femelle pré-sertie JIC 37° double hexagonal



DN	ROSCA THREAD	Referencia Part n°	€
1/4"	7/16" 20h UNF	852420704	24,41
3/8"	1/2" 20 UNF	NEW 852420806	33,45
3/8"	9/16" 18h UNF	852420906	26,25
1/2"	3/4" 16h UNF	852421208	30,62
1/2"	7/8" 14UNF	NEW 852421408	43,77
5/8"	7/8" 14UNF	NEW 852421410	50,45
5/8"	1"1/16 12 UN	NEW 852421710	54,80
3/4"	1"1/16 12h UN	852421712	52,28
1"	1"5/16 12h UN	852422116	80,84
1"1/4	1"5/8 12h UN	852422620	150,01
1"1/2	1"7/8 12h UN	852423024	199,07
2"	2"1/2 12h UN	NEW 852424032	363,10

One piece JIC 37° female (45° Elbow)

Hembras giratorias 45° una sola pieza rosca JIC 37°

Dichtkopf einteilig Ü-Mutter 37° JIC 45°

45° Femelle pré-sertie JIC 37°



DN	ROSCA THREAD	Referencia Part n°	€
1/4"	7/16" 20h UNF	851390704	30,38
3/8"	9/16" 18h UNF	851390906	36,15
1/2"	3/4" 16h UNF	851391208	39,80
3/4"	1"1/16 12h UN	851391712	67,29
1"	1"5/16 12h UN	851392116	103,89
1"1/4	1"5/8 12h UN	NEW 851392620	174,91
1"1/2	1"7/8 12h UN	NEW 851393024	268,46
2"	2"1/2 12h UN	NEW 851394032	577,91

ONE PIECE FITTINGS FOR CONVOLUTED PTFE

Conexiones una sola pieza PTFE Corrugado
Einteilige Armaturen PTFE-Wellenschlauch
Embouts pré-sertis pour PTFE convoluté

One piece doble hexagonal ORFS female

Hembras giratorias rectas una sola pieza rosca ORFS doble hexagonal

Dichtkopf mit ORFS einteilig Ü-Mutter doppelt 6 kt

Femelle pré-sertie ORFS double hexagonal



DN	ROSCA THREAD	Referencia Part n°	€
1/4"	9/16"-18h	859000904	39,12
3/8"	11/16"-16h	859001106	44,02
1/2"	13/16"-16h	859001308	51,78
3/4"	1"3/16-12h	859001912	105,02
1"	1"7/16-12h	859002316	113,90
1"1/4	1"11/16-16h	NEW 859002720	205,07
1"1/2	2" 12h	NEW 859003224	247,51

One piece ORFS male

Machos una sola pieza rosca ORFS

Außengewinde einteilig ORFS

Mâle pré-serti ORFS



DN	ROSCA THREAD	Referencia Part n°	€
1/4"	9/16"-18h	859120904	45,55
3/8"	11/16"-16h	859121106	43,79
1/2"	13/16"-16h	859121308	55,21
3/4"	1"3/16-12h	859121912	98,49
1"	1"7/16-12h	859122316	142,73
1"1/4	1"11/16 12h	NEW 859122720	194,96
1"1/2	2" 12h	NEW 859123224	285,14

One piece ORFS female (90° Elbow)

Hembras giratorias 90° una sola pieza rosca ORFS

Dichtkopf mit ORFS einteilig Ü-Mutter 90°

90° Femelle pré-sertie ORFS



DN	ROSCA THREAD	Referencia Part n°	€
1/4"	9/16"-18h	859070904	68,22
3/8"	11/16"-16h	859071106	80,10
1/2"	13/16"-16h	859071308	91,66
3/4"	1"3/16-12h	859071912	150,30
1"	1"7/16-12h	859072316	221,35
1"1/4	1"11/16-16h	NEW 859072720	303,49
1"1/2	2" 12h	NEW 859073224	810,16

One piece ORFS female (45° Elbow)

Hembras giratorias 45° una sola pieza rosca ORFS

Dichtkopf mit ORFS einteilig Ü-Mutter 45°

45° Femelle pré-sertie ORFS



DN	ROSCA THREAD	Referencia Part n°	€
1/4"	9/16"-18h	859080904	68,22
3/8"	11/16"-16h	859081106	80,10
1/2"	13/16"-16h	859081308	91,67
3/4"	1"3/16-12h	859081912	150,30
1"	1"7/16-12h	859082316	221,35
1"1/4	1"11/16-16h	NEW 859082720	303,49
1"1/2	2" 12h	NEW 859083224	810,16

ONE PIECE FITTINGS FOR CONVOLUTED PTFE

Conexiones una sola pieza PTFE Corrugado
Einteilige Armaturen PTFE-Wellenschlauch
Embouts pré-sertis pour PTFE convoluté

One piece NPSM female 60° cone

Hembras giratorias rectas una sola pieza rosca NPSM cono 60°

Dichtkopf mit NPSM einteilig Ü-Mutter 60° kon.

Femelle pré-sertie NPSM cone 60°



DN	ROSCA THREAD	Referencia Part n°	€
1/4"	1/4" 18h NPSM	852610404	22,90
3/8"	3/8" 18h NPSM	852610606	23,82
1/2"	1/2" 14h NPSM	852610808	31,56
3/4"	3/4" 14h NPSM	852611212	49,26
1"	1" - 11 1/2 h NPSM	852611616	80,29

One piece NPSM female 60° cone (90° Elbow)

Hembras giratorias 90° una sola pieza rosca NPSM cono 60°

Dichtkopf mit NPSM einteilig Ü-Mutter 60° kon. 90°

90° Femelle pré-sertie NPSM cone 60°



DN	ROSCA THREAD	Referencia Part n°	€
1/4"	1/4" 18h NPSM	852620404	33,10
3/8"	3/8" 18h NPSM	852620606	35,38
1/2"	1/2" 14h NPSM	852620808	45,91
3/4"	3/4" 14h NPSM	852621212	77,81
1"	1" - 11 1/2 h NPSM	852621616	110,75

One piece NPSM female 60° cone (45° Elbow)

Hembras giratorias 45° una sola pieza rosca NPSM cono 60°

Dichtkopf mit NPSM einteilig Ü-Mutter 60° kon. 45°

45° Femelle pré-sertie NPSM cone 60°



DN	ROSCA THREAD	Referencia Part n°	€
1/4"	1/4" 18h NPSM	852630404	33,10
3/8"	3/8" 18h NPSM	852630606	35,38
1/2"	1/2" 14h NPSM	852630808	45,91
3/4"	3/4" 14h NPSM	852631212	77,82
1"	1" - 11 1/2 h NPSM	852631616	110,75

One piece NPT male pipe straight

Machos una sola pieza rosca cónica NPT

Außengewinde einteilig kon. NPT

Mâle pré-serti NPT



DN	ROSCA THREAD	Referencia Part n°	€
1/4"	1/8" NPT	NEW 851610204	27,53
1/4"	1/4" NPT	851610404	20,68
5/16"	1/4" NPT	NEW 851610405	28,69
3/8"	1/4" NPT	NEW 851610406	30,11
1/4"	3/8" NPT	NEW 851610604	29,41
5/16"	3/8" NPT	NEW 851610605	31,37
3/8"	3/8" NPT	851610606	21,56
1/2"	3/8" NPT	NEW 851610608	36,86
3/8"	1/2" NPT	NEW 851610806	36,59
1/2"	1/2" NPT	851610808	29,48
5/8"	1/2" NPT	NEW 851610810	40,84
1/2"	3/4" NPT	NEW 851611208	48,66
5/8"	3/4" NPT	NEW 851611210	48,61
3/4"	3/4" NPT	851611212	44,97
3/4"	1" NPT	NEW 851611612	68,20
1"	1" NPT	851611616	72,52
1"	1 1/4" NPT	NEW 851612016	115,20
1 1/4"	1 1/4" NPT	NEW 851612020	124,16
1 1/2"	1 1/2" NPT	NEW 851612424	153,31
2"	2" NPT	NEW 851613232	262,94

One piece double hexagonal NPSM female 60° cone

Hembras giratorias rectas una sola pieza rosca NPSM cono 60° doble hexagonal

Dichtkopf mit NPSM einteilig Ü-Mutter 60° kon. doppelt 6 kt

Femelle pré-sertie NPSM cone 60° double hexagonal



DN	ROSCA THREAD	Referencia Part n°	€
1/4"	1/4" NPSM	853610404	35,85
3/8"	3/8" 18h NPSM	853610606	36,91
1/2"	1/2" 14h NPSM	853610808	42,54
3/4"	3/4" NPSM	853611212	63,27
1"	1" - 11 1/2 h NPSM	853611616	100,16

CRIMPING FITTINGS FOR HOSES

PIPE FITTINGS

PIPE FITTINGS II

ADAPTORS

WELDING FITTINGS

INDUSTRIAL FITTINGS

ACCESSORIES

CONTROL COMPONENTS

FLOW MEASURING

TRALE LOK

ONE PIECE FITTINGS FOR CONVOLUTED PTFE

Conexiones una sola pieza PTFE Corrugado
Einteilige Armaturen PTFE-Wellenschlauch
Embouts pré-sertis pour PTFE convoluté

One piece Metric female 24° cone

Hembras giratorias rectas una sola pieza rosca Métrica cono 24° - DKO

Dichtkopf metr. einteilig Ü-Mutter kon. 24°

Femelle pré-sertie Métrique cone 24°



DN	TUBO PIPE	SERIE SERIES	ROSCA THREAD	Referencia Part n°	€
1/4"	8	L	M14x1.5	85804140804	19,52
3/8"	12	L	M18x1.5	85804181206	21,63
1/2"	15	L	M22x1.5	85804221508	29,36
3/4"	22	L	M30x2	85804302212	48,17
1"	28	L	M36x2	85804362816	78,14
1 1/4"	35	L	M45x2	NEW 85804453520	117,37
1 1/2"	42	L	M52x2	NEW 85804524224	159,64
1/4"	8	S	M16x1.5	85804160804	22,35
3/8"	12	S	M20x1.5	85804201206	24,80
1/2"	16	S	M24x1.5	85804241608	29,15
3/4"	25	S	M36x2	85804362512	67,11
1"	30	S	M42x2	85804423016	98,70
1 1/4"	38	S	M52x2	NEW 85804523820	150,81

One piece Metric male 24° cone

Machos una sola pieza rosca Métrica cono 24°

Außengewinde einteilig metr. kon. 24°

Mâle pré-serti Métrique cone 24°



DN	TUBO PIPE	SERIE SERIES	ROSCA THREAD	Referencia Part n°	€
1/4"	8	L	M14x1.5	85203140804	22,86
3/8"	12	L	M18x1.5	85203181206	20,49
1/2"	15	L	M22x1.5	85203221508	29,39
3/4"	22	L	M30x2	85203302212	53,10
1"	28	L	M36x2	85203362816	79,47
1 1/4"	35	L	M45x2	NEW 85203453520	121,16
1 1/2"	42	L	M52x2	NEW 85203524224	184,41
1/4"	8	S	M16x1.5	85203160804	28,49
3/8"	12	S	M20x1.5	85203201206	31,24
1/2"	16	S	M24x1.5	85203241608	32,38
3/4"	25	S	M36x2	85203362512	72,73
1"	30	S	M42x2	85203423016	112,30
1 1/4"	38	S	M52x2	NEW 85203523820	167,37

One piece Metric female 24° cone (90° Elbow)

Hembras giratorias 90° una sola pieza rosca Métrica cono 24° - DKO 90°

Dichtkopf 90° metr. einteilig Ü-Mutter kon. 24°

90° Femelle pré-sertie Métrique cone 24°



DN	TUBO PIPE	ROSCA THREAD	SERIE SERIES	Referencia Part n°	€
1/4"	8	M14x1.5	L	85305140804	29,83
3/8"	12	M18x1.5	L	85305181206	34,17
1/2"	15	M22x1.5	L	85305221508	43,45
3/4"	22	M30x2	L	85305302212	72,79
1"	28	M36x2	L	85305362816	113,86
1 1/4"	35	M45x2	L	NEW 85305453520	194,15
1 1/2"	42	M52x2	L	NEW 85305524224	283,45
1/4"	8	M16x1.5	S	85305160804	34,40
3/8"	12	M20x1.5	S	85305201206	39,34
1/2"	16	M24x1.5	S	85305241608	46,24
3/4"	25	M36x2	S	85305362512	96,25
1"	30	M42x2	S	85305423016	149,44
1 1/4"	38	M52x2	S	NEW 85305523820	245,94

One piece Metric female 24° cone (45° Elbow)

Hembras giratorias 45° una sola pieza rosca Métrica cono 24° - DKO 45°

Dichtkopf 45° metr. einteilig Ü-Mutter kon. 24°

45° Femelle pré-sertie Métrique cone 24°



DN	TUBO PIPE	SERIE SERIES	ROSCA THREAD	Referencia Part n°	€
1/4"	8	L	M14x1.5	85306140804	29,83
3/8"	12	L	M18x1.5	85306181206	34,39
1/2"	15	L	M22x1.5	85306221508	42,28
3/4"	22	L	M30x2	85306302212	72,79
1"	28	L	M36x2	85306362816	113,86
1 1/4"	35	L	M45x2	NEW 85306453520	194,15
1 1/2"	42	L	M52x2	NEW 85306524224	283,45
1/4"	8	S	M10x1.5	85306160804	34,40
3/8"	12	S	M20x1.5	85306201206	39,34
1/2"	16	S	M24x1.5	85306241608	46,24
3/4"	25	S	M36x2	85306362512	96,25
1"	30	S	M42x2	85306423016	148,33
1 1/4"	38	S	M52x2	NEW 85306523820	245,94

ONE PIECE FITTINGS FOR CONVOLUTED PTFE

Conexiones una sola pieza PTFE Corrugado
Einteilige Armaturen PTFE-Wellenschlauch
Embouts pré-sertis pour PTFE convoluté

One piece BSP female 60° cone

Hembras giratorias rectas una sola pieza rosca BSP cono 60°

Dichtkopf mit Ü-Mutter einteilig BSP 60° kon.

Femelle pré-sertie BSP cone 60°



DN	ROSCA THREAD	Referencia Part n°	€
1/4"	1/4" BSP	851000404	18,69
3/8"	3/8" BSP	851000606	21,01
1/2"	1/2" BSP	851000808	26,51
3/4"	3/4" BSP	851001212	42,42
1"	1" BSP	851001616	67,17
1"1/4"	1"1/4 BSP	NEW 851002020	118,34
1"1/2"	1"1/2 BSP	NEW 851002424	148,79
2"	2" BSP	NEW 851003232	257,95

One piece BSP male 60° cone

Machos una sola pieza rosca cilíndrica BSP cono 60°

Außengewinde zyl. einteilig kon. BSP 60°

Mâle pré-serti BSP cone 60°



DN	ROSCA THREAD	Referencia Part n°	€
1/4"	1/4" BSP	851120404	22,48
3/8"	3/8" BSP	851120606	22,77
1/2"	1/2" BSP	851120808	29,95
3/4"	3/4" BSP	851121212	45,96
1"	1" BSP	851121616	83,24
1"1/4"	1"1/4 BSP	NEW 851122020	132,81
1"1/2"	1"1/2 BSP	NEW 851122424	169,17
2"	2" BSP	NEW 851123232	271,76

One piece BSP female 60° cone (90° Elbow)

Hembras giratorias 90° una sola pieza rosca BSP cono 60°

Dichtkopf mit Ü-Mutter einteilig BSP 60° kon. 90°

90° Femelle pré-sertie BSP cone 60°



DN	ROSCA THREAD	Referencia Part n°	€
1/4"	1/4" BSP	851070404	28,20
3/8"	3/8" BSP	851070606	30,77
1/2"	1/2" BSP	851070808	39,67
3/4"	3/4" BSP	851071212	65,02
1"	1" BSP	851071616	98,90
1"1/4"	1"1/4 BSP	NEW 851072020	183,60
1"1/2"	1"1/2 BSP	NEW 851072424	249,33
2"	2" BSP	NEW 851073232	454,04

One piece double hexagonal BSP female 60° cone

Hembras giratorias rectas una sola pieza rosca BSP cono 60° doble hexagonal

Dichtkopf mit Ü-Mutter einteilig BSP 60° kon. doppelt 6 kt

Femelle pré-sertie BSP cone 60° double hexagonal



DN	ROSCA THREAD	Referencia Part n°	€
1/4"	1/4" BSP	854000404	30,26
3/8"	3/8" BSP	854000606	31,12
1/2"	1/2" BSP	854000808	36,29
3/4"	3/4" BSP	854001212	58,41
1"	1" BSP	854001616	92,42
1"1/4"	1"1/4 BSP	NEW 854002020	128,80
1"1/2"	1"1/2 BSP	NEW 854002424	193,47
2"	2" BSP	NEW 854003232	328,24

One piece BSP female 60° cone (45° Elbow)

Hembras giratorias 45° una sola pieza rosca BSP cono 60°

Dichtkopf mit Ü-Mutter einteilig BSP 60° kon. 45°

45° Femelle pré-sertie BSP cone 60°



DN	ROSCA THREAD	Referencia Part n°	€
1/4"	1/4" BSP	851080404	28,21
3/8"	3/8" BSP	851080606	31,44
1/2"	1/2" BSP	851080808	39,67
3/4"	3/4" BSP	851081212	65,02
1"	1" BSP	851081616	98,90
1"1/4"	1"1/4 BSP	NEW 851082020	170,36
1"1/2"	1"1/2 BSP	NEW 851082424	249,33
2"	2" BSP	NEW 851083232	454,05

CRIMPING FITTINGS FOR HOSES

PIPE FITTINGS

PIPE FITTINGS II

ADAPTORS

WELDING FITTINGS

INDUSTRIAL FITTINGS

ACCESSORIES

CONTROL COMPONENTS

FLOW MEASURING

TRALE LOK

ONE PIECE FITTINGS BW SERIES R12/4SP/4SH NO SKIVE

Conexiones una sola pieza Serie BW R12/4SP/4SH No Pelar
 Einteilige Armaturen Serie BW R12/4SP/4SH ohne Schälung
 Embouts pré-sertis R12/4SP/4SH Série BW Sans dénuder

One piece double hexagonal JIC 37° Swivel female

Hembras giratorias rectas una sola pieza JIC 37° doble hexagonal

Dichtkopf mit Ü-Mutter einteilig 37° JIC doppelt 6 kt

Femelle pré-sertie JIC 37° double hexagonal



DN	ROSCA THREAD	Referencia Part n°	€
5/8"	7/8" 14h UNF	Z682421410	61,50
3/4"	1"1/16 12h UN	Z682421712	68,79
1"	1"1/16 12h UN	NEW Z682421716	116,15
1"	1"5/16 12h UN	Z682422116	110,67
1"1/4	1"5/8 12h UN	Z682422620	211,49
1"1/2	1"7/8 12h UN	Z682423024	267,34
2"	2"1/2 12h UN	Z682424032	463,87

Until end of stock / Hasta fin de existencias / Bis zum Ende des Lagerbestandes / Jusqu'à la fin du stock

One piece JIC 37° male with o'ring

Machos una sola pieza rosca JIC 37° con junta

Außengewinde einteilig JIC 37° mit O-Ring

Mâle pré-serti JIC 37° avec joint torique



DN	ROSCA THREAD	Referencia Part n°	€
1/2"	3/4" 16h UNF	Z681411208	47,89
5/8"	7/8" 14h UNF	Z681411410	68,93
3/4"	1"1/16 12h UNF	Z681411712	86,46
1"	1"5/16 12h UNF	Z681412116	121,98
1"1/4	1"5/8 12h UNF	Z681412620	227,42

Until end of stock / Hasta fin de existencias / Bis zum Ende des Lagerbestandes / Jusqu'à la fin du stock

One piece JIC 37° Swivel female (90° Elbow)

Hembras giratorias 90° una sola pieza rosca JIC 37°

Dichtkopf mit Ü-Mutter einteilig 37° JIC 90°

Coude 90° femelle pré-sertie JIC 37°



DN	ROSCA THREAD	Referencia Part n°	€
1/2"	3/4" 16h UNF	Z681381208	52,79
5/8"	7/8" 14h UNF	Z681381410	69,06
3/4"	1"1/16 12h UNF	Z681381712	86,22
1"	1"5/16 12h UNF	Z681382116	137,43
1"1/4	1"5/8 12h UNF	Z681382620	240,36
1"1/2	1"7/8 12h UNF	Z681383024	362,55
2"	2"1/2 12h UNF	Z681384032	713,27

Until end of stock / Hasta fin de existencias / Bis zum Ende des Lagerbestandes / Fino ad esaurimento

One piece JIC 37° Swivel female (45° Elbow)

Hembras giratorias 45° una sola pieza rosca JIC 37°

Dichtkonus JIC 37° einteilig 45°

Coude 45° femelle pré-sertie JIC 37°



DN	ROSCA THREAD	Referencia Part n°	€
1/2"	3/4" 16h UNF	Z681391208	49,86
5/8"	7/8" 14h UNF	Z681391410	72,63
3/4"	1"1/16 12h UNF	Z681391712	86,22
1"	1"5/16 12h UNF	Z681392116	137,42
1"1/4	1"5/8 12h UNF	Z681392620	240,36
1"1/2	1"7/8 12h UNF	Z681393024	347,90
2"	2"1/2 12h UNF	Z681394032	713,27

Until end of stock / Hasta fin de existencias / Bis zum Ende des Lagerbestandes / Fino ad esaurimento

ONE PIECE FITTINGS BW SERIES R12/4SP/4SH NO SKIVE

Conexiones una sola pieza Serie BW R12/4SP/4SH No Pelar
Einteilige Armaturen Serie BW R12/4SP/4SH ohne Schälung
Embouts pré-sertis R12/4SP/4SH Série BW Sans dénuder

One piece ORFS Swivel female straight double hexagonal

Hembras giratorias rectas una sola pieza ORFS
doble hexagonal

Dichtkopf mit ORFS einteilig Ü-Mutter doppelt 6 kt

Femelle pré-sertie droite ORFS double hexagonale



DN	ROSCA THREAD	Referencia Part n°	€
1/2"	13/16"-16h	Z689011308	61,87
3/4"	1"3/16-12h	Z689011912	100,89
1"	1"7/16-12h	Z689012316	149,05
1"1/4	1" 11/16-12h	Z689012720	275,41
1"1/2	2"-12h	Z689013224	323,58

Until end of stock / Hasta fin de existencias / Bis zum Ende des Lagerbestandes / Jusqu'à la fin du stock

One piece ORFS Swivel female (90° Elbow)

Hembras giratorias 90° una sola pieza ORFS

Dichtkopf mit ORFS einteilig Ü-Mutter 90°

Coude 90° femelle pré-sertie ORFS



DN	ROSCA THREAD	Referencia Part n°	€
1/2"	13/16"-16h	Z689071308	110,09
3/4"	1"3/16-12h	Z689071912	177,64
1"	1"7/16-12h	Z689072316	265,28
1"1/4	1" 11/16-12h	Z689072720	389,64

Until end of stock / Hasta fin de existencias / Bis zum Ende des Lagerbestandes / Jusqu'à la fin du stock

One piece ORFS Male

Machos compactos ORFS

Außengewinde ORFS einteilig

Mâle pré-serti ORFS



DN	ROSCA THREAD	Referencia Part n°	€
3/4"	1"3/16-12h	Z689121912	122,44
1"	1"7/16-12h	Z689122316	177,63

Until end of stock / Hasta fin de existencias / Bis zum Ende des Lagerbestandes / Jusqu'à la fin du stock

One piece ORFS Swivel female (45° Elbow)

Hembras giratorias 45° una sola pieza ORFS

Dichtkopf mit ORFS einteilig Ü-Mutter 45°

Coude 45° femelle pré-sertie ORFS



DN	ROSCA THREAD	Referencia Part n°	€
3/4"	1"3/16-12h	Z689081912	177,64
1"	1"7/16-12h	Z689082316	265,27
1"1/4	1" 11/16-12h	Z689082720	389,64

Until end of stock / Hasta fin de existencias / Bis zum Ende des Lagerbestandes / Jusqu'à la fin du stock

One piece NPT Male pipe straight

Machos cónicos una sola pieza NPT

Außengewinde kon. einteilig NPT

Mâle pré-serti conique NPT



DN	ROSCA THREAD	Referencia Part n°	€
1/2"	1/2" NPT	Z681610808	37,89
3/4"	3/4" NPT	Z681611212	60,30
1"	1" NPT	Z681611616	101,01
1"1/4	1"1/4 NPT	Z681612020	181,47
1"1/2	1"1/2 NPT	Z681612424	214,21

Until end of stock / Hasta fin de existencias / Bis zum Ende des Lagerbestandes / Fino ad esaurimento

One piece double hexagonal NPSM female 60° cone with o'ring

Hembras giratorias rectas una sola pieza NPSM
cono 60° doble hexagonal con junta

Dichtkopf mit NPSM einteilig Ü-Mutter 60° kon.
doppelt 6 kt mit O-Ring

Femelle pré-sertie NPSM cone 60° double
hexagonal avec joint torique



DN	ROSCA THREAD	Referencia Part n°	€
3/4"	3/4" NPSM	Z684611212	99,52
1"	1" NPSM	Z684611616	148,66

Until end of stock / Hasta fin de existencias / Bis zum Ende des Lagerbestandes / Fino ad esaurimento

ONE PIECE FITTINGS BW SERIES R12/4SP/4SH NO SKIVE

Conexiones una sola pieza Serie BW R12/4SP/4SH No Pelar
Einteilige Armaturen Serie BW R12/4SP/4SH ohne Schälung
Embouts pré-sertis R12/4SP/4SH Série BW Sans dénuder

One piece 3000 PSI SAE Straight Flange / Code 61

Bridas rectas una sola pieza SAE 3000 PSI

Gerader Kompaktflansch SAE 3000 PSI

Bride SAE droite pré-sertie série 3000 PSI



DN	Ø	Referencia Part n°	€
1/2"	30.2	Z681820808	65,28
3/4"	38.1	Z681821212	93,19
1"	44.5	Z681821616	128,53
1"1/4	50.8	Z681822020	193,63
1"1/4	60.3	NEW Z681822420	229,64
1"1/2	60.3	Z681822424	248,04
2"	71.4	Z681823232	394,11

Until end of stock / Hasta fin de existencias / Bis zum Ende des Lagerbestandes / Jusqu'à la fin du stock

One piece 3000 PSI SAE Flange (90° Elbow) / Code 61

Bridas 90° una sola pieza SAE 3000 PSI

Kompaktflansch 90° SAE 3000 PSI

Bride SAE coude 90° pré-sertie série 3000 PSI



DN	Ø	Referencia Part n°	€
3/4"	38.1	Z681831212	127,52
1"	44.5	Z681831616	176,45
1"1/4	50.8	Z681832020	275,81
1"1/2	60.3	Z681832424	373,34
2"	71.4	Z681833232	555,22

Until end of stock / Hasta fin de existencias / Bis zum Ende des Lagerbestandes / Jusqu'à la fin du stock

One piece 3000 PSI SAE Flange (45° Elbow) / Code 61

Bridas 45° una sola pieza SAE 3000 PSI

Kompaktflansch 45° SAE 3000 PSI

Bride SAE coude 45° pré-sertie série 3000 PSI



DN	Ø	Referencia Part n°	€
3/4"	38.1	Z681841212	127,52
1"	44.5	Z681841616	176,45
1"1/4	50.8	Z681842020	275,81
1"1/2	60.3	Z681842424	373,34
2"	71.4	Z681843232	555,22

Until end of stock / Hasta fin de existencias / Bis zum Ende des Lagerbestandes / Jusqu'à la fin du stock

One piece 6000 PSI SAE Straight Flange / Code 62

Bridas rectas una sola pieza SAE 6000 PSI

Gerader Kompaktflansch SAE 6000 PSI

Bride SAE droite pré-sertie série 6000 PSI



DN	Ø	Referencia Part n°	€
1/2"	30.2	Z682820808	73,79
3/4"	41.3	Z682821212	106,59
1"	47.6	Z682821616	148,09
1"1/4	54	Z682822020	222,91
1"1/2	63.5	Z682822424	288,51
2"	79.4	Z682823232	473,70

Until end of stock / Hasta fin de existencias / Bis zum Ende des Lagerbestandes / Jusqu'à la fin du stock

One piece 6000 PSI SAE Flange (90° Elbow) / Code 62

Bridas 90° una sola pieza SAE 6000 PSI

Kompaktflansch 90° SAE 6000 PSI

Bride SAE coude 90° pré-sertie série 6000 PSI



DN	Ø	Referencia Part n°	€
1/2"	30.2	Z682830808	89,00
5/8"	38.1	Z682831210	144,22
3/4"	41.3	Z682831212	135,37
1"	47.6	Z682831616	203,63
1"1/4	54	Z682832020	286,27
1"1/2	63.5	Z682832424	459,52
2"	79.4	Z682833232	582,00

Until end of stock / Hasta fin de existencias / Bis zum Ende des Lagerbestandes / Fino ad esaurimento

One piece 6000 PSI SAE Flange (45° Elbow) / Code 62

Bridas 45° una sola pieza SAE 6000 PSI

Kompaktflansch 45° SAE 6000 PSI

Bride SAE coude 45° pré-sertie série 6000 PSI



DN	Ø	Referencia Part n°	€
1/2"	30.2	Z682840808	89,00
5/8"	38.1	Z682841210	144,22
3/4"	41.3	Z682841212	135,47
1"	47.6	Z682841616	203,63
1"1/4	54	Z682842020	284,79
1"1/2	63.5	Z682842424	458,61
2"	79.4	Z682843232	582,00

Until end of stock / Hasta fin de existencias / Bis zum Ende des Lagerbestandes / Fino ad esaurimento

ONE PIECE FITTINGS BW SERIES R12/4SP/4SH NO SKIVE

Conexiones una sola pieza Serie BW R12/4SP/4SH No Pelar
Einteilige Armaturen Serie BW R12/4SP/4SH ohne Schälung
Embouts pré-sertis R12/4SP/4SH Série BW Sans dénuder

One piece Metric swivel female 24° seat with o'ring

Hembras giratorias rectas una sola pieza rosca Métrica cono 24° con junta tórica

Dichtkopf mit Ü-Mutter kon. 24° einteilig

Femelle pré-sertie Métrique 24° avec o'ring



DN	TUBO PIPE	SERIE SERIES	ROSCA THREAD	Referencia Part n°	€
1/2"	16	S	M24x1.5	Z68204241608	37,50
3/4"	20	S	M30x2	Z68204302012	77,38
3/4"	25	S	M36x2	Z68204362512	86,01
1"	30	S	M42x2	Z68204423016	131,40
1"1/4	38	S	M52x2	Z68204523820	212,41

Until end of stock / Hasta fin de existencias / Bis zum Ende des Lagerbestandes / Fino ad esaurimento

One piece Metric male stud 24° cone

Macho una sola pieza Métricos cono 24°

Außengewinde metr. einteilig kon. 24°

Mâle pré-serti Métrique cone 24°



DN	TUBO PIPE	SERIE SERIES	ROSCA THREAD	Referencia Part n°	€
3/4"	20	S	M30x2	Z68203302012	74,01
3/4"	25	S	M36x2	Z68203362512	92,53
1"	30	S	M42x2	Z68203423016	147,19
1"1/4	38	S	M52x2	Z68203523820	231,64

Until end of stock / Hasta fin de existencias / Bis zum Ende des Lagerbestandes / Jusqu'à la fin du stock

One piece Metric swivel female 24° seat with o'ring (90° Elbow)

Hembras giratorias 90° una sola pieza Métricas cono 24° con junta tórica

Dichtkegel 90° mit Ü-Mutter kon. 24° einteilig

Coude 90° femelle pré-sertie Métrique 24° avec o'ring



DN	TUBO PIPE	SERIE SERIES	ROSCA THREAD	Referencia Part n°	€
3/4"	20	S	M30x2	Z68205302012	96,46
3/4"	25	S	M36x2	Z68205362512	119,83
1"	30	S	M42x2	Z68205423016	190,31
1"1/4	38	S	M52x2	Z68205523820	322,86

Until end of stock / Hasta fin de existencias / Bis zum Ende des Lagerbestandes / Jusqu'à la fin du stock

One piece Metric swivel female 24° seat with o'ring (45° Elbow)

Hembras giratorias 45° una sola pieza Métricas cono 24° con junta tórica

Dichtkegel 45° mit Ü-Mutter kon. 24° einteilig

Coude 45° femelle pré-sertie Métrique 24° avec o'ring



DN	TUBO PIPE	SERIE SERIES	ROSCA THREAD	Referencia Part n°	€
3/4"	20	S	M30x2	Z68206302012	96,46
3/4"	25	S	M36x2	Z68206362512	119,83
1"	30	S	M42x2	Z68206423016	189,03
1"1/4	38	S	M52x2	Z68206523820	322,86

Until end of stock / Hasta fin de existencias / Bis zum Ende des Lagerbestandes / Jusqu'à la fin du stock

ONE PIECE FITTINGS BW SERIES R12/4SP/4SH NO SKIVE

Conexiones una sola pieza Serie BW R12/4SP/4SH No Pelar
Einteilige Armaturen Serie BW R12/4SP/4SH ohne Schälung
Emboutis pré-sertis R12/4SP/4SH Série BW Sans dénuder

One piece double hexagonal BSP Swivel female cone 60° with joint

Hembras giratorias una sola pieza BSP 60° doble hexagonal

Dichtkopf einteilig 60° kon. doppelt hexagonal mit dichtung

Femelle BSP pré-sertie cone 60° double hexagonal +joint



DN	ROSCA THREAD	Referencia Part n°	€
1/2"	1/2" BSP	Z684100808	66,53
5/8"	5/8" BSP	Z684101210	93,88
3/4"	3/4" BSP	Z684101212	96,55
1"	1" BSP	Z684101616	143,85
1"1/4	1"1/4 BSP	Z684102020	270,95
1"1/2	1"1/2 BSP	Z684102424	369,42
2"	2" BSP	Z684103232	695,45

Until end of stock / Hasta fin de existencias / Bis zum Ende des Lagerbestandes / Jusqu'à la fin du stock

One piece BSP Male 60° cone

Machos cilíndricos una sola pieza BSP 60°

Außengewinde zyl. einteilig BSP 60°

Mâle pré-serti gaz cylindrique BSP 60°



DN	ROSCA THREAD	Referencia Part n°	€
1/2"	1/2" BSP	Z681120808	38,44
3/4"	3/4" BSP	Z681121212	61,45
1"	1" BSP	Z681121616	111,27
1"1/4	1"1/4 BSP	Z681122020	191,52
2"	2" BSP	Z681123232	357,82

Until end of stock / Hasta fin de existencias / Bis zum Ende des Lagerbestandes / Jusqu'à la fin du stock

One piece BSP Swivel female 60° cone with o'ring (90° Elbow)

Hembras giratorias 90° una sola pieza BSP 60° con junta tórica

Dichtkopf mit BSP Ü-Mutter 60° einteilig 90° mit O-Ring

Coude 90° femelle pré-sertie BSP 60° avec o'ring



DN	ROSCA THREAD	Referencia Part n°	€
1/2"	1/2" BSP	Z681170808	60,02
3/4"	3/4" BSP	Z681171212	90,28
1"	1" BSP	Z681171616	147,92
1"1/4	1"1/4 BSP	Z681172020	272,68

Until end of stock / Hasta fin de existencias / Bis zum Ende des Lagerbestandes / Jusqu'à la fin du stock

One piece BSP Swivel female 60° cone with o'ring (45° Elbow)

Hembras giratorias 45° una sola pieza BSP 60° con junta tórica

Dichtkopf mit BSP Ü-Mutter 60° einteilig 45° mit O-Ring

Coude 45° femelle pré-sertie BSP 60° avec o'ring



DN	ROSCA THREAD	Referencia Part n°	€
1/2"	1/2" BSP	Z681180808	55,87
3/4"	3/4" BSP	Z681181212	84,23
1"	1" BSP	Z681181616	133,79
1"1/4	1"1/4 BSP	Z681182020	227,52

Until end of stock / Hasta fin de existencias / Bis zum Ende des Lagerbestandes / Jusqu'à la fin du stock

BWS

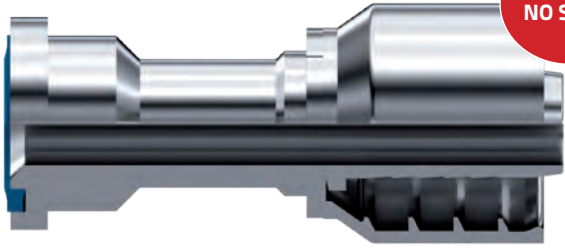

NO PELAR
NO SKIVE



MAYOR VERSATILIDAD. 1 CASQUILLO - 4 MANGUERAS
GREATER VERSATILITY. 1 FERRULE - 4 HOSES



REDUCCIÓN DE STOCK. USO DE ESPIGA STD
STOCK OPTIMISATION. STD SERIES



MENOR TIEMPO DE MONTAJE. NO PELAR
REDUCES ASSEMBLY TIME. NO SKIVE



AHORRO ECONÓMICO.
ECONOMIC EFFICIENCY



BW+

NEW



NO PELAR
NO SKIVE



ALTA PRESIÓN
HIGH PRESSURE

1" 1/4 - 1" 1/2-2

R13 - R15



REDUCCIÓN DE STOCK. USO DE ESPIGA BW
STOCK OPTIMISATION. BW SERIES



MENOR TIEMPO DE MONTAJE. NO PELAR
REDUCES ASSEMBLY TIME. NO SKIVE



ONE PIECE FITTINGS BW+ SERIES R13/R15 NO SKIVE

Conexiones una pieza Serie BW+ R13/R15 No Pelar
 Armaturen Serie BW+ R13/R15 ohne Schälung
 Embouts R13/R15 Série BW+ Sans denuder

R13 & R15 Ø 3/4" - 1" ->> BWS

One piece double hexagonal JIC 37° Swivel female

Hembras giratorias rectas una sola pieza JIC 37° doble hexagonal

Dichtkopf mit Ü-Mutter einteilig 37° JIC doppelt 6 kt

Femelle pré-sertie JIC 37° double hexagonal



DN	THREAD ROSCA	Part n° Referencia	€
1"1/4	1"5/8 12 UN	Z692422620	278,42
1"1/2	1"7/8 12 UN	Z692423024	414,96
2"	2" 1/2 12 UN	Z692424032	618,04

One piece JIC 37° male with o'ring

Machos una sola pieza rosca JIC 37° C/J

Außengewinde einteilig JIC 37° mit O-Ring

Mâle pré-serti JIC 37° avec joint torique



DN	THREAD ROSCA	Part n° Referencia	€
1"1/4	1"5/8 12 UN	Z691412620	172,97
1"1/2	1"7/8 12 UN	Z691413024	207,42
2"	2" 1/2 12 UN	Z691414032	381,82

One piece JIC 37° Swivel female (90° Elbow)

Hembras giratorias 90° una sola pieza rosca JIC 37°

Dichtkopf mit Ü-Mutter einteilig 37° JIC 90°

Coude 90° femelle pré-sertie JIC 37°



DN	THREAD ROSCA	Part n° Referencia	€
1"1/4	1"5/8 12 UN	Z691382620	202,20
1"1/2	1"7/8 12 UN	Z691383024	291,32
2"	2" 1/2 12 UN	Z691384032	538,42

One piece JIC 37° Swivel female (45° Elbow)

Hembras giratorias 45° una sola pieza rosca JIC 37°

Dichtkonus JIC 37° einteilig 45°

Coude 45° femelle pré-sertie JIC 37°



DN	THREAD ROSCA	Part n° Referencia	€
1"1/4	1"5/8 12 UN	Z691392620	202,20
1"1/2	1"7/8 12 UN	Z691393024	291,32
2"	2" 1/2 12 UN	Z691394032	538,42

One piece ORFS Swivel female straight double hexagonal

Hembras giratorias rectas una sola pieza ORFS doble hexagonal

Dichtkopf mit ORFS einteilig Ü-Mutter doppelt 6 kt

Femelle pré-sertie droite ORFS double hexagonale



DN	THREAD ROSCA	Part n° Referencia	€
1"1/4	1" 11/16 12 UN	Z699012720	219,53
1"1/2	2" 12 UN	Z699013224	315,90

One piece ORFS Swivel female (90° Elbow)

Hembras giratorias 90° una sola pieza ORFS

Dichtkopf mit ORFS einteilig Ü-Mutter 90°

Coude 90° femelle pré-sertie ORFS



DN	THREAD ROSCA	Part n° Referencia	€
1"1/4	1" 11/16 12 UN	Z699072720	517,62
73	2" 12 UN	Z699073224	1.404,24

One piece ORFS Swivel female (45° Elbow)

Hembras giratorias 45° una sola pieza ORFS

Dichtkopf mit ORFS einteilig Ü-Mutter 45°

Coude 45° femelle pré-sertie ORFS



DN	THREAD ROSCA	Part n° Referencia	€
1"1/4	1"11/16 12 UN	Z699082720	517,62
1"1/2	2" 12 UN	Z699083224	1.404,24

One piece ORFS Male

Machos una sola pieza ORFS

Außengewinde ORFS einteilig

Mâle pré-serti ORFS



DN	THREAD ROSCA	Part n° Referencia	€
1"1/4	1"11/16 12 UN	Z699122720	337,82
1"1/2	2" 12 UN	Z699123224	495,96

ONE PIECE FITTINGS BW+ SERIES R13/R15 NO SKIVE

Conexiones una pieza Serie BW+ R13/R15 No Pelar

Armaturen Serie BW+ R13/R15 ohne Schälung

Embouts R13/R15 Série BW+ Sans denuder

R13 & R15 Ø 3/4" - 1" ->> BWS

One piece double hexagonal NPSM female 60° cone

NEW

Hembras giratorias rectas una sola pieza rosca NPSM cono 60° doble hexagonal
Dichtkopf mit NPSM einteilig Überwurfmutter 60° kon. doppelt hexagonal
Femelle pré-sertie NPSM cone 60° double hexagonal



DN	THREAD ROSCA	Part n° Referencia	€
1"1/4	1"1/4 - 11 1/2 h NPSM	Z693612020	267,81
1"1/2	1"1/2 - 11 1/2 h NPSM	Z693612424	364,68
2"	2" - 11 1/2 h NPSM	Z693613232	559,45

One piece NPT Male pipe straight

NEW

Machos una sola pieza rosca cónica NPT
Außengewinde kon. einteilig NPT
Mâle pré-serti conique NPT



DN	THREAD ROSCA	Part n° Referencia	€
1"1/4	1"1/4 - 11 1/2 h NPSM	Z691612020	164,59
1"1/2	1"1/2 - 11 1/2 h NPSM	Z691612424	238,22
2"	2" - 11 1/2 h NPSM	Z691613232	424,94

One piece 6000 PSI SAE Straight Flange / Code 62

NEW

Bridas recta SAE 6000 PSI
Gerader Kompaktflansch SAE 6000 PSI
Bride SAE droite pré-sertie série 6000 PSI



DN	Ø	Part n° Referencia	€
1"1/4	1"1/4	Z692822020	198,05
1"1/2	1"1/2	Z692822424	265,16
2"	2"	Z692823232	415,96

One piece 6000 PSI SAE Flange (90° Elbow) / Code 62

NEW

Bridas a 90° SAE 6000 PSI
Kompaktflansch 90° SAE 6000 PSI
Bride SAE coude 90° pré-sertie série 6000 PSI



DN	Ø	Part n° Referencia	€
1"1/4	1"1/4	Z692832020	244,68
1"1/2	1"1/2	Z692832424	388,08
2"	2"	Z692833232	559,64

One piece 6000 PSI SAE Flange (45° Elbow) / Code 62

NEW

Bridas a 45° SAE 6000 PSI
Kompaktflansch 45° SAE 6000 PSI
Bride SAE coude 45° pré-sertie série 6000 PSI



DN	Ø	Part n° Referencia	€
1"1/4	1"1/4	Z692842020	244,68
1"1/2	1"1/2	Z692842424	388,08
2"	2"	Z692843232	559,64

ONE PIECE FITTINGS BW+ SERIES R13/R15 NO SKIVE

Conexiones una pieza Serie BW+ R13/R15 No Pelar
Armaturen Serie BW+ R13/R15 ohne Schälung
Embouts R13/R15 Série BW+ Sans denuder

R13 & R15 Ø 3/4" - 1" ->> BWS

One piece BSP Male 60° cone

Machos cilíndricos una sola pieza BSP 60°

Außengewinde zyl. einteilig BSP 60°

Mâle pré-serti gaz cylindrique BSP 60°



DN	THREAD ROSCA	Part n° Referencia	€
1"1/4	1"1/4 BSP	Z691122020	171,44
1"1/2	1"1/2 BSP	Z691122424	237,66
2"	2" BSP	Z691123232	419,66

One piece BSP Swivel female 60° cone with o'ring (90° Elbow)

Hembras giratorias 90° una sola pieza BSP 60° C/J

Dichtkopf mit BSP Ü-Mutter 60° einteilig 90° mit O-Ring

Coude 90° femelle pré-sertie BSP 60° avec o'ring



DN	THREAD ROSCA	Part n° Referencia	€
1"1/4	1"1/4 BSP	Z691172020	216,17
1"1/2	1"1/2 BSP	Z691172424	302,72
2"	2" BSP	Z691173232	511,14

One piece double hexagonal BSP Swivel female cone 60° with o'ring

Hembras giratorias una sóla pieza BSP 60° doble hexagonal con junta

Dichtkopf einteilig 60° kon. doppelt hexagonal mit O-Ring

Femelle BSP pré-sertie cone 60° double hexagonal with o'ring



DN	THREAD ROSCA	Part n° Referencia	€
1"1/4	1"1/4 BSP	Z694102020	258,41
1"1/2	1"1/2 BSP	Z694102424	352,18
2"	2" BSP	Z694103232	662,70

One piece BSP Swivel female 60° cone with o'ring (45° Elbow)

Hembras giratorias 45° una sola pieza BSP 60° C/J

Dichtkopf mit BSP Ü-Mutter 60° einteilig 45° mit O-Ring

Coude 45° femelle pré-sertie BSP 60° avec o'ring



DN	THREAD ROSCA	Part n° Referencia	€
1"1/4	1"1/4 BSP	Z691182020	216,17
1"1/2	1"1/2 BSP	Z691182424	302,72
2"	2" BSP	Z691183232	511,14

BAJO CONSULTA
UNDER REQUEST

BW+ MÉTRICAS / METRIC BW+

■ Hembras giratorias rectas una sola pieza rosca Métrica cono 24° con junta tórica

One piece Metric swivel female 24° seat with o'ring

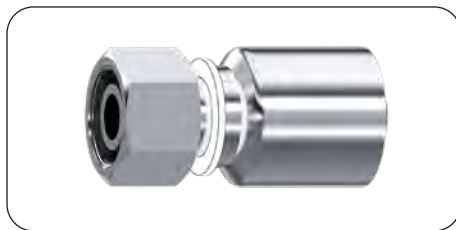

Ref: Z69204

■ Hembras giratorias 90° una sola pieza Métricas cono 24° con junta tórica

One piece Metric swivel female 24° seat with o'ring



Ref: Z69205

■ Macho una sola pieza Métricos cono 24°

One piece Metric male stud 24° cone

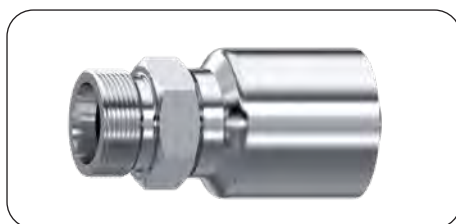

Ref: Z69203

■ Hembras giratorias 45° una sola pieza Métricas cono 24° con junta tórica

One piece Metric swivel female 24° seat with o'ring

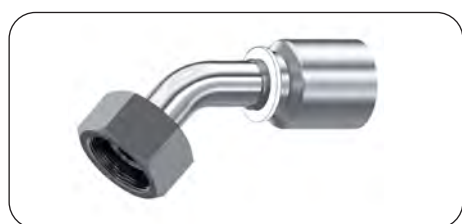

Ref: Z69206

FERRULES FOR ONE PIECE FITTINGS

Casquillos para conexiones una sola pieza
 Pressfassungen für einteilige Armaturen
 Jupes pour embouts pré-sertis

Ferrules R1AT/R2AT/1SN/2SN/R16/2SC/R17 for one piece fittings 43 series

Casquillos R1AT/R2AT/1SN/2SN /R16/2SC/R17 una sola pieza serie 43

Pressfassungen R1AT/R2AT/1SN/2SN/R16/2SC/R17 für einteilige Armaturen Serie 43

Jupes R1AT/R2AT/1SN/2SN/R16/2SC/R17 pour embouts pré-sertis série 43



DN	Referencia Part n°	€
1/4"	ZPFC221200400	10,30
5/16"	ZPFC221200500	13,93
3/8"	ZPFC221200600	13,47
1/2"	ZPFC221200800	14,09
5/8"	ZPFC221201000	17,34
3/4"	ZPFC221201200	24,38
1"	ZPFC221201600	41,95
1"1/4"	ZPFC221202000	73,70
1"1/2"	ZPFC221202400	88,52
2"	ZPFC221203200	128,19

Ferrules 3SP/4SP/R12/4SH standard series non skive

Casquillos 3SP/4SP/R12/4SH serie standard no pelar

Pressfassungen 3SP/4SP/R12/4SH Armaturen ohne Schälung

Jupes 3SP/4SP/R12/4SH série standard sans dénudage



DN	Referencia Part n°	€
3/8"	ZPF222400600	10,84
1/2"	ZPF222400800	13,69
5/8"	ZPF222401000	25,13
3/4"	ZPF222401200	22,46
1"	ZPF222401600	35,03
1" 1/4"	ZPF222402000	65,75
1" 1/2"	NEW ZPF222402400	94,12
2"	NEW ZPF222403200	133,77

Ferrules R7, R8 and braid of steel wire for one piece fittings

Casquillos R7, R8 y elastómero malla metálica una sola pieza

Pressfassungen R7/R8 und Elastomer/Metallumfl. für einteilige Armaturen

Jupes R7, R8 et elastomère tresse métallique pour embouts pré-sertis



DN	Referencia Part n°	€
3/16"	880120300	8,33
1/4"	880120400	8,75
5/16"	880120500	10,00
3/8"	880120600	10,33
1/2"	880120800	11,72
3/4"	880121200	17,39
1"	880121600	29,50

Ferrules smooth PTFE for one piece fittings

Casquillos PTFE Liso una sola pieza

Pressfassungen für PTFE-Glattschläuche mit einteiligen Armaturen

Jupes PTFE Lisse pour embouts pré-sertis



DN	Referencia Part n°	€
1/4"	880400400	6,81
5/16"	880400500	8,59
3/8"	880400600	8,07
1/2"	880400800	9,02
5/8"	880401000	17,01

For other sizes, use 81040 p.24 / Para otras medidas, usar 81040 p.24 / Für andere Größen 81040 auf S. 24 / Pour les autres dimensions, utiliser 81040 p.24

Ferrules convoluted PTFE for one piece fittings

Casquillos PTFE Corrugado una sola pieza

Pressfassungen für PTFE-Wellschläuche mit einteiligen Armaturen

Jupes PTFE Convoluté pour embouts pré-sertis



DN	Referencia Part n°	€
1/4"	880410400	8,05
5/16"	880410500	7,28
3/8"	880410600	8,28
1/2"	880410800	10,94
5/8"	880411000	14,82
3/4"	880411200	17,41

For other sizes, use 81041 p.24 / Para otras medidas, usar 81041 p.24 / Für andere Größen 81041 auf S. 24 / Pour les autres dimensions, utiliser 81041 p.24

Ferrules 1SC/1SN/2SC/R6

Casquillos 1SC/1SN/2SC/R6

Pressfassungen 1SC/1SN/2SC/R6

Jupes 1SC/1SN/2SC/R6



DN	Referencia Part n°	€
1/4"	ZSCC21120400	10,06
5/16"	ZSCC21120500	12,74
3/8"	ZSCC21120600	12,22
1/2"	ZSCC21120800	13,89
5/8"	ZSCC21121000	18,94
3/4"	ZSCC21121200	25,55
1"	ZSCC21121600	40,05

FERRULES FOR ONE PIECE FITTINGS

Casquillos para conexiones una sola pieza
Pressfassungen für einteilige Armaturen
Jupes pour embouts pré-sertis

Ferrules R12/4SP/4SH for fittings BW series

Casquillos R12/4SP/4SH para serie BW

Pressfassungen R12/4SP/4SH für Armaturen Serie BW

Jupes R12/4SP/4SH pour embouts série BW



DN	Referencia Part n°	€
1/2"	ZAC680100800	26,11
5/8"	ZAC680101000	28,67
3/4"	ZAC680101200	36,60
1"	ZAC680101600	47,04
1"1/4	ZAC680102000	72,77
1"1/2	ZAC680102400	106,05
2"	ZAC680103200	158,78

Until end of stock / Hasta fin de existencias / Bis zum Ende des Lagerbestandes / Jusqu'à la fin du stock

Ferrules R13/R15 for fittings BW/BW+ series

Casquillos R13/R15 para serie BW/BW+

Jupes R13/R15 pour embouts série BW/BW+

Boccole a pressione per R13/R15 per raccordi serie BW/BW+



NEW

DN	Referencia Part n°	\$
1"1/4	ZAC690102000	105,87
1"1/2	ZAC690102400	132,37
2"	ZAC690103200	194,69

REUSABLE SERIES

Conexiones Reusables
Schraubarmaturen
Embouts série récupérable

Reusable ferrules R1T/1SN non skive

Casquillos reus para manguera R1T/1SN no pelar

Schraubfassung für R1T/1SN ohne Schälén

Jupes récupérables R1T/1SN sans dénudage



DN	Referencia Part n°	€
1/4"	Z1G-4 R1T INOX	33,33
5/16"	Z1G-5 R1T INOX	46,14
3/8"	Z1G-6 R1T INOX	29,33
1/2"	Z1G-8 R1T INOX	37,05
3/4"	Z1G-12 R1T INOX	49,12
1"	Z1G-16 R1T INOX	74,02

Reusable ferrules R2AT/2SN non skive

Casquillos reus para manguera R2AT/2SN no pelar

Schraubfassung für R2AT/2SN ohne Schälén

Jupes récupérables R2AT/2SN sans dénudage



DN	Referencia Part n°	€
1/4"	Z1G-4 R2T INOX	34,26
3/8"	Z1G-6 R2T INOX	28,20
1/2"	Z1G-8 R2T INOX	31,69
5/8"	Z1G-10 R2T INOX	51,64
3/4"	Z1G-12 R2T INOX	60,85
1"	Z1G-16 R2T INOX	79,95

Reusable BSP Swivel female 60° cone

Hembras giratorias rectas reusables rosca BSP cono 60°

Dichtkopf mit BSP Ü-Mutter

Femelle récupérable gaz cylindrique 60°



DN	ROSCA THREAD	Referencia Part n°	€
1/4"	1/4" BSP	Z3G-4	34,76
5/16"	3/8" BSP	Z3G-6-5	38,65
3/8"	3/8" BSP	Z3G-6	37,32
3/8"	1/2" BSP	Z3G-8-6	45,10
1/2"	1/2" BSP	Z3G-8	43,32
3/4"	3/4" BSP	Z3G-12	65,90
1"	1" BSP	Z3G-16	112,69
1"1/4"	1"1/4" BSP	Z3G-20*	219,56
1"1/2"	1"1/2" BSP	Z3G-24*	265,64

*Until end of stock / Hasta fin de existencias / Bis zum Ende des Lagerbestandes / Jusqu'à la fin du stock

Reusable BSP 60° cone (90° Elbow)

Hembras giratorias 90° reusables rosca BSP cono 60°

Dichtkopf mit BSP Ü-Mutter 90° Bogen

Coude 90° femelle récupérable gaz cylindrique BSP 60°



DN	ROSCA THREAD	Referencia Part n°	€
1/4"	1/4" BSP	Z90G-4	61,86
3/8"	3/8" BSP	Z90G-6	74,12
3/8"	1/2" BSP	Z90G-8-6	97,12
1/2"	1/2" BSP	Z90G-8	91,65
3/4"	3/4" BSP	Z90G-12	123,26
1"	1" BSP	Z90G-16	194,06

Reusable BSP Male parallel 60° cone

Machos reusables rosca cilíndrica BSP cono 60°

BSP Einschraubzapfen zyl. DIN 3852 Form A

Mâle récupérable gaz cylindrique BSP 60°



DN	ROSCA THREAD	Referencia Part n°	€
1/4"	1/4" BSP	Z2G-4	41,71
3/8"	3/8" BSP	Z2G-6-5	49,63
3/8"	3/8" BSP	Z2G-6	37,62
1/2"	1/2" BSP	Z2G-8-6	44,71
1/2"	1/2" BSP	Z2G-8	41,48
3/4"	3/4" BSP	Z2G-12	68,36
1"	1" BSP	Z2G-16	89,23

REUSABLE SERIES

Conexiones Reusables
Schraubarmaturen
Embouts série récupérable

Reusable JIC 37° straight Swivel female

Hembras giratorias rectas reusables rosca JIC cono 37°

Schraubarmaturen Ü-Mutter Dichtkonus JIC 37°

Femelle droite récupérable JIC 37°



DN	ROSCA THREAD	Referencia Part n°	€
1/4"	7/16" 20h UNF	Z3J-07-04	38,23
3/8"	9/16" 18h UNF	Z3J-09-06	41,04
1/2"	3/4" 16h UNF	Z3J-12-08	47,66
1/2"	7/8" 14h UNF	Z3J-14-08	66,50
5/8"	7/8" 14h UNF	Z3J-14-10	57,82
3/4"	1"1/16 12h UNF	Z3J-17-12	73,94
1"	1"5/16 12h UNF	Z3J-21-16	123,95

Reusable JIC Male 37° cone

Machos reusables rosca JIC cono 37°

Schraubarmaturen Außengewindenippel Dichtkonus JIC 37°

Mâle récupérables JIC cône 37°



DN	ROSCA THREAD	Referencia Part n°	€
1/4"	7/16" 20h UNF	Z2J-07-04	39,97
3/8"	9/16" 18h UNF	Z2J-09-06	42,26
1/2"	3/4" 16h UNF	Z2J-12-08	49,43
1/2"	7/8" 14h UNF	Z2J-14-08	72,61
5/8"	7/8" 14h UNF	Z2J-14-10	71,98
3/4"	1"1/16" 12h UNF	Z2J-17-12	78,61
1"	1"5/16" 12h UNF	Z2J-21-16	130,77

90° reusable Swivel female thread JIC cone 37°

Hembras giratorias 90° reusables rosca JIC cono 37°

90° drehbarer, wiederverwendbarer JIC-Konus mit -Gewinde 37°

Femelle tournante 90° filetage récupérable cône JIC 37°



DN	ROSCA THREAD	Referencia Part n°	€
1/4"	7/16" 20h UNF	Z3J90-07-04	*
3/8"	9/16" 18h UNF	Z3J90-09-06	*
1/2"	3/4" 16h UNF	Z3J90-12-08	*
1/2"	7/8" 14h UNF	Z3J90-14-08	*
5/8"	7/8" 14h UNF	Z3J90-14-10	*
3/4"	1"1/16 12h UN	Z3J90-17-12	*
1"	1"5/16 12h UN	Z3J90-21-16	*

45° reusable Swivel female thread JIC cone 37°

Hembras giratorias 45° reusables rosca JIC cono 37°

45° drehbarer, wiederverwendbarer JIC-Konus mit -Gewinde 37°

Femelle tournante 45° filetage récupérable cône JIC 37°



DN	ROSCA THREAD	Referencia Part n°	€
1/4"	7/16" 20h UNF	Z3J45-07-04	*
3/8"	9/16" 18h UNF	Z3J45-09-06	*
1/8"	3/4" 16h UNF	Z3J45-12-08	*
1/2"	7/8" 14h UNF	Z3J45-14-08	*
5/8"	7/8" 14h UNF	Z3J45-14-10	*
3/4"	1"1/16 12h UN	Z3J45-17-12	*
1"	1"5/16 12h UN	Z3J45-21-16	*

Reusable NPT Male

Machos reusables rosca NPT

Wiederverwendbare Außengewinde NPT

Mâle récupérable NPT



DN	ROSCA THREAD	Referencia Part n°	€
1/4	1/4" NPT	Z2NPT-04-04	33,02
3/8	3/8" NPT	Z2NPT-06-06	35,53
1/2	1/2" NPT	Z2NPT-08-08	39,41
3/4	3/4" NPT	Z2NPT-12-12	64,94
1"	1" NPT	Z2NPT-16-16	84,77

Reusable Metric standpipe

Espigas lisas Métricas reusables

Met. Einschraubstutzen glatt

Embout lisse récupérable Métrique



DN	TUBO PIPE	Referencia Part n°	€
1/4"	6	ZE-6-4	32,42
1/4"	8	ZE-8-4	30,85
3/8"	8	ZE-8-6	29,96
1/4"	10	ZE-10-4	30,85
5/16"	10	ZE-10-5	31,28
3/8"	10	ZE-10-6	44,84
5/16"	12	ZE-12-5	31,28
3/8"	12	ZE-12-6	44,84
3/8"	15	ZE-15-6	44,84
1/2"	15	ZE-15-8	44,01
1/2"	16	ZE-16-8	43,98
3/4"	22	ZE-22-12	66,68
3/4"	25	ZE-25-12	92,40
1"	25	ZE-25-16	*
1"	28	ZE-28-16	*
1"	30	ZE-30-16	*

REUSABLE SERIES

Conexiones Reusables
Schraubarmaturen
Embouts série récupérable

Reusable R5 JIC 37° straight swivel female

Hembras giratorias rectas reusables R5 rosca JIC cono 37°

Wiederverwendbare gerade drehbare Innengewinde R5 JIC mit 37° -Konus

Femelle pivotante droite réutilisable R5 JIC filetage 37° cône



DN	ROSCA THREAD	Referencia Part n°	€
3/16"	7/16" 20 UNF	Z3J-07-04-R5	40,29
1/4"	7/16" 20h UNF	Z3J-07-05-R5	40,72
1/4"	1/2" 20h UNF	Z3J-08-05-R5	42,71
5/16"	9/16" 18h UNF	Z3J-09-06-R5	43,18
13/32"	3/4" 16h UNF	Z3J-12-08-R5	50,86
1/2"	3/4" 16h UNF	Z3J-12-10-R5	63,91
1/2"	7/8"x14 UNF	Z3J-14-10-R5	66,33
5/8"	1" 1/16" 12 UNF	Z3J-17-12-R5	80,52
7/8"	1" 5/16" 12 UNF	Z3J-21-16-R5	126,23
1" 1/8"	1" 5/8 12 UNF	Z3J-26-20-R5	294,21
1" 3/8"	1" 7/8 12 UNF	Z3J-30-24-R5	331,40
1" 13/16"	2" 1/2 12UNF	Z3J-40-32-R5	483,21

Reusable R5 JIC 37° swivel female (90° elbow)

Hembras giratorias 90° reusables R5 rosca JIC cono 37°

90° drehbarer, wiederverwendbarer JIC-Konus mit R5-Gewinde 37°

Femelle pivotante 90° filetage R5 réutilisable cône JIC 37°



DN	ROSCA THREAD	Referencia Part n°	€
3/16"	7/16" 20 UNF	Z3J90-07-04-R5	*
1/4"	7/16" 20h UNF	Z3J90-07-05-R5	*
1/4"	1/2" 20h UNF	Z3J90-08-05-R5	*
5/16"	9/16" 18h UNF	Z3J90-09-06-R5	*
13/32"	3/4" 16h UNF	Z3J90-12-08-R5	*
1/2"	3/4" 16h UNF	Z3J90-12-10-R5	*
1/2"	7/8" 14 UNF	Z3J90-14-10-R5	*
5/8"	1" 1/16 12 UNF	Z3J90-17-12-R5	*
7/8"	1" 5/16" 12 UNF	Z3J90-21-16-R5	*

Reusable R5 JIC 37° swivel female (45° elbow)

Hembras giratorias 45° reusables R5 rosca JIC cono 37°

45° wiederverwendbar. Innengewinde R5, JIC-Konus 37°

Femelle pivotante 45° réutilisable Filetage R5 Cône JIC 37°



DN	ROSCA THREAD	Referencia Part n°	€
3/16"	7/16" 20 UNF	Z3J45-07-04-R5	*
1/4"	7/16" 20h UNF	Z3J45-07-05-R5	*
1/4"	1/2" 20h UNF	Z3J45-08-05-R5	*
5/16"	9/16" 18h UNF	Z3J45-09-06-R5	*
13/32"	3/4" 16h UNF	Z3J45-12-08-R5	*
1/2"	3/4" 16h UNF	Z3J45-12-10-R5	*
1/2"	7/8" 14 UNF	Z3J45-14-10-R5	*
5/8"	1" 1/16 12 UNF	Z3J45-17-12-R5	*
7/8"	1" 5/16" 12 UNF	Z3J45-21-16-R5	*

Reusable R5 NPT Male

Machos reusables R5 rosca NPT

Wiederverwendbare Außengewinde R5 NPT

Mâle récupérables R5 NPT



DN	ROSCA THREAD	Referencia Part n°	€
3/16"	1/4" NPT	Z2P-04-04-R5	38,30
1/4"	1/4" NPT	Z2P-04-05-R5	39,83
5/16"	3/8" NPT	Z2P-06-06-R5	40,50
13/32"	1/2" NPT	Z2P-08-08-R5	45,71
1/2"	1/2" NPT	Z2P-08-10-R5	55,54
5/8"	3/4" NPT	Z2P-12-12-R5	75,34
7/8"	1" NPT	Z2P-16-16-R5	98,33
1" 1/8"	1" 1/4 NPT	Z2P-20-20-R5	128,89
1" 3/8"	1" 1/2 NPT	Z2P-24-24-R5	212,23
1" 13/16"	2" NPT	Z2P-32-32-R5	347,95

CONEXIONES REUSABLES R5

REUSABLE R5 FITTINGS



Consulta datos en nuestra ficha técnica | Check our technical sheet for data

Sistemas hidráulicos de **media presión** con fluidos basados en petróleo o agua/glycol, aceites y lubricantes.

Medium pressure hydraulic systems with petroleum or water/glycol based fluids and for fuel and lubricating oils

PUSH-ON FITTINGS

Conexiones Push-On
Aufsteck-Armaturen
Embouts Push-On

BSP Swivel female 60° cone

Hembras giratorias rectas rosca BSP cono 60°

Dichtkopf mit BSP Ü-Mutter

Femelle tournante BSP cono 60°



DN	ROSCA THREAD	Referencia Part n°	€
1/4"	1/4" BSP	891000404	18,96
3/8"	3/8" BSP	891000606	17,37
1/2"	1/2" BSP	891000808	21,90
5/8"	5/8" BSP	891001010	40,68
3/4"	3/4" BSP	891001212	28,11
1"	1" BSP	891001616	44,51

BSP Male 60° cone

Machos rosca cilíndrica BSP cono 60°

Außengewinde BSP

Mâle fixe BSP cono 60°



DN	ROSCA THREAD	Referencia Part n°	€
1/4"	1/4" BSP	891120404	20,22
3/8"	3/8" BSP	891120606	17,30
1/2"	1/2" BSP	891120808	27,92
3/4"	1/2" BSP	891120812	39,75
5/8"	5/8" BSP	891121010	33,74
3/4"	3/4" BSP	891121212	46,65
1"	1" BSP	891121616	55,71

JIC 37° Swivel female

Hembras giratorias rectas JIC 37°

Dichtkonus mit Ü-Mutter JIC 37°

Femelle tournante JIC 37°



DN	ROSCA THREAD	Referencia Part n°	€
1/4"	7/16" 20h UNF	891420704	14,94
3/8"	9/16" 18h UNF	891420906	18,47
1/2"	3/4" 16h UNF	891421208	21,72
5/8"	7/8" 14h UNF	891421410	24,72
3/4"	1" 1/16 12h UN	891421712	38,60
1"	1" 5/16 12h UN	891422116	47,82

JIC 37° Male

Machos rosca JIC cono 37°

Außengewinde JIC 37°

Mâle fixe JIC 37°



DN	ROSCA THREAD	Referencia Part n°	€
1/4"	7/16" 20h UNF	891400704	18,32
3/8"	9/16" 18h UNF	891400906	25,36
1/2"	3/4" 16h UNF	891401208	25,16
5/8"	7/8" 14h UNF	891401410	35,57
3/4"	1" 1/16 12h UN	891401712	42,47
1"	1" 5/16 12h UN	891402116	52,08

NPT Male pipe straight

Machos rosca cónica NPT

Außengewinde NPT

Mâle gaz conique NPT (BRIGGS)



DN	ROSCA THREAD	Referencia Part n°	€
1/4"	1/4" NPT	891610404	15,72
3/8"	3/8" NPT	891610606	21,94
1/2"	1/2" NPT	891610808	25,85
3/4"	3/4" NPT	891611212	38,13
1"	1" NPT	891611616	45,79

Metric female swivel with o-ring 24° cone

Hembra giratoria recta Métrica cono 24°

Dichtkopf metr. Ü-Mutter kon. 24°

Femelle Métrique avec o-ring cône 24°



DN	TUBO PIPE	SERIE SERIES	ROSCA THREAD	Referencia Part n°	€
1/4"	8	L	M14x1.5	89804140804	21,44
1/4"	10	L	M16x1.5	89804161004	20,54
3/8"	12	L	M18x1.5	89804181206	19,58
1/2"	15	L	M22x1.5	89804221508	22,81
3/4"	22	L	M30x2	89804302212	35,03

Metric stud 24° cone

Machos rosca métrica cono 24°

Gewindezapfen L/S DIN 20078 D/E

Mâle Métrique cône 24°



DN	TUBO PIPE	SERIE SERIES	ROSCA THREAD	Referencia Part n°	€
1/4"	8	L	M14x1.5	89203140804	25,04
1/4"	10	L	M16x1.5	89203161004	18,86
3/8"	12	L	M18x1.5	89203181206	19,81
1/2"	15	L	M22x1.5	89203221508	27,47
3/4"	22	L	M30x2	89203302212	35,41

HIGH PRESSURE 700 BAR FITTINGS

Conexiones Alta Presión (700 bar)
 Armaturen Hochdruck (700bar)
 Embouts haute pression 700 bar

Ferrules for thermoplastic hose 700 bar

Casquillos para alta presión (700bar)

Pressfassungen Hochdruck (700bar)

Jupes à sertir thermoplastique 700 bar



DN	Referencia Part n°	€
1/4"	Z710120400	35,24
3/8"	Z710120600	36,64
1/2"	Z710120800	38,84

BSP Swivel female 60° cone 700 bar

Hembra giratoria BSP cono 60° (700bar)

Dichtkopf mit Ü-Mutter BSP 60° (700bar)

Embout 700 bar femelle tournante gaz cyl BSP 60°



DN	ROSCA THREAD	Referencia Part n°	€
1/4"	1/4" BSP	Z741000404	60,83
3/8"	3/8" BSP	Z741000606	64,00
1/2"	1/2" BSP	Z741000808	66,57

BSP Male parallel 60° cone 700 bar

Macho BSP cono 60° (700bar)

Außengewinde BSP kon. 60° (700bar)

Embout 700 bar mâle fixe gaz cyl BSP 60°



DN	ROSCA THREAD	Referencia Part n°	€
1/4"	1/4" BSP	Z741120404	70,15
3/8"	3/8" BSP	Z741120606	72,45
1/2"	1/2" BSP	Z741120808	78,49

NPSM Swivel female 60° cone 700 bar

Hembra giratoria NPSM cono 60° (700bar)

Dichtkonus mit NPSM 60°

Embout 700 bar femelle tournante NPSM 60°



DN	ROSCA THREAD	Referencia Part n°	€
1/4"	1/4" 18h NPSM	Z742610404	60,83
3/8"	3/8" 18h NPSM	Z742610606	67,37
1/2"	1/2" 14h NPSM	Z742610808	70,08

NPT Male pipe straight 700 bar

Macho NPT (700bar)

Außengewinde NPT (700bar)

Embout 700 bar mâle fixe gaz conique NPT



DN	ROSCA THREAD	Referencia Part n°	€
1/4"	1/4" NPT	Z741610404	70,15
1/4"	3/8" NPT	Z741610604	76,07
3/8"	3/8" NPT	Z741610606	72,45
1/2"	1/2" NPT	Z741610808	78,49

JIC 37° Swivel female 700 bar

Hembra giratoria JIC 37° (700bar)

Dichtkopf mit Ü-Mutter JIC 37° (700bar)

Embout 700 bar femelle tournante droit JIC 37°



DN	ROSCA THREAD	Referencia Part n°	€
1/4"	7/16" 20h UNF	Z741420704	66,91
1/4"	9/16" 18h UNF	Z741420904	74,77
3/8"	9/16" 18h UNF	Z741420906	70,40
1/2"	3/4" 16h UNF	Z741421208	73,24

JIC 37° Male thread 700 bar

Macho JIC 37° (700bar)

Außengewinde JIC 37° (700bar)

Embout 700 bar mâle fixe JIC 37°



DN	ROSCA THREAD	Referencia Part n°	€
1/4"	7/16" 20h UNF	Z741400704	81,23
3/8"	9/16" 18h UNF	Z741400906	83,88
1/2"	3/4" 16h UNF	Z741401208	90,89

Metric Swivel female 24° cone 700 bar

Hembra giratoria Métrica 24° (700bar)

Dichtkopf Ü-Mutter metr. 24° (700bar)

Embout 700 bar femelle tournante droit Métrique cone 24°



DN	TUBO PIPE	SERIE SERIES	ROSCA THREAD	Referencia Part n°	€
1/4"	8	S	M16x1.5	Z74804160804	87,54
3/8"	12	S	M20x1.5	Z74804201206	89,47
1/2"	16	S	M24x1.5	Z74804241608	90,33

Metric Male 24° cone 700 bar

Macho Métrico 24° (700bar)

Außengewinde metr. 24° (700bar)

Embout 700 bar mâle fixe Métrique cone 24°



DN	TUBO PIPE	SERIE SERIES	ROSCA THREAD	Referencia Part n°	€
1/4"	8	S	M16x1.5	Z74203160804	93,79
3/8"	12	S	M20x1.5	Z74203201206	104,84
1/2"	16	S	M24x1.5	Z74203241608	116,95

TABLAS DE PRENSADO Y CERTIFICADOS
disponibles en el área de **DESCARGAS** de nuestra web

www.dicsaes.com

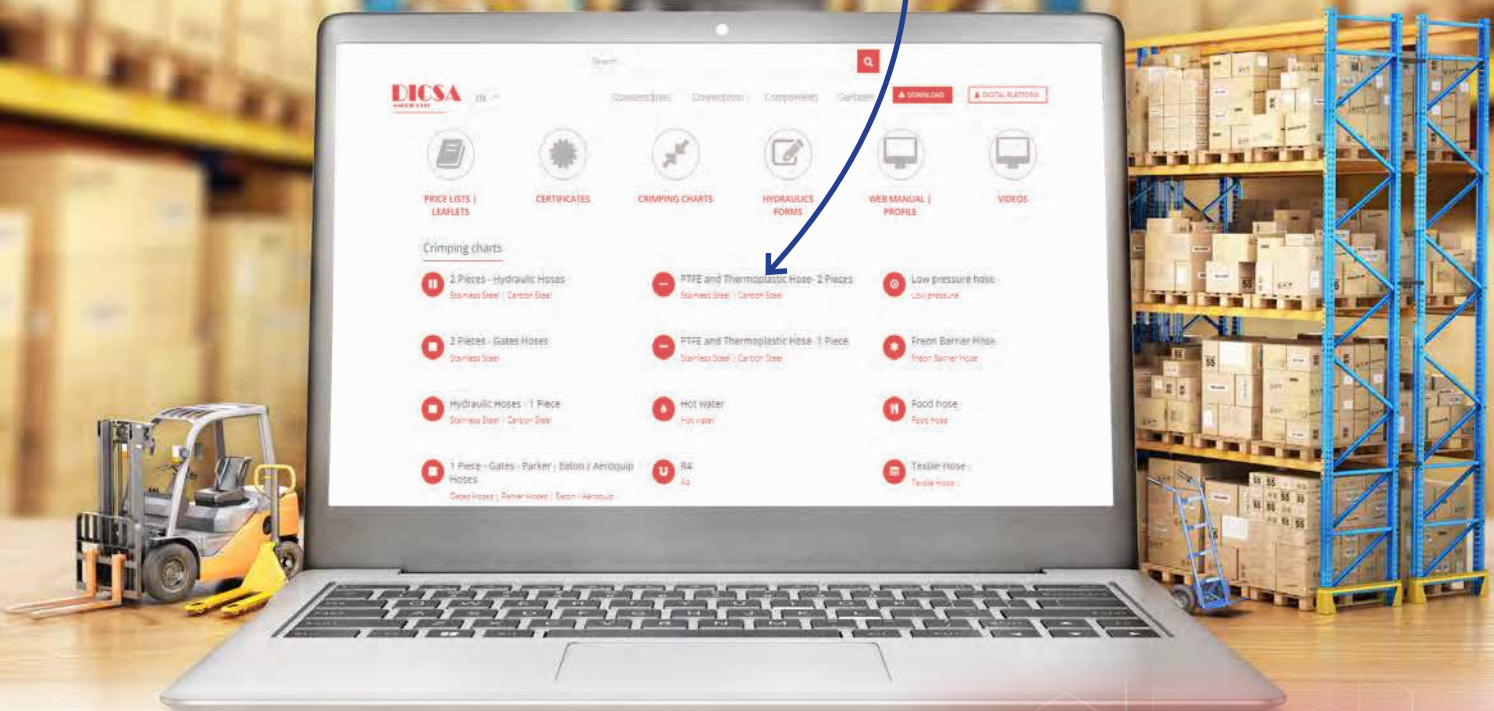

CRIMPING CHARTS & CERTIFICATES
available in the **DOWNLOAD** area



Hose configurator +
**ASISTENTE
LATIGUILLOS**
makes your work easier

Gestión intuitiva, rápida, fiable y eficiente
Simple, fast, reliable and efficient management

ELIGE LA MANGUERA



SELECCIONA LAS CONEXIONES



ELIGE LAS PROTECCIONES



PEDIDO FINAL

CHOOSE THE HOSE



SELECT THE FITTINGS



CHOOSE THE PROTECTIONS



ORDER

Póngase en contacto con nosotros para más información
Contact us for further information

MACHINES & ACCESSORIES

Máquinas y Accesorios
 Bearbeitungsmaschinen und Zubehör
 Machines et Accessoires

PM 18 6J N

- 80 t
- +20 mm
- 59 mm
- 28 kg.



TrDelta®
 1" 2SP
 3/4" 4SP
 1/2" 6SP

PM16-SPEED-8J | PM16-8J

- 100 t
- +20 mm
- 59 mm
- 25 kg.



TrDelta®
 1" 3SP

PM18F-9J

- 120 t
- +20 mm
- 65 mm
- 22 kg.



TrDelta®
 1" 4SP

PM22-9J

- 140 t
- +25 mm
- 110 mm



TrDelta®
 1" 1/4 4SP

PE 38 15j NT

- 220 t
- +32 mm
- 130 mm



TrDelta®
 2" 4 SP
 1" 6SP

PE 50 17J NT

- 420 t
- +32mm
- 130 mm



TrDelta®
 2" 6 SP

SE 28 5j N/10J N

- 137 t
- +28 mm
- 100 mm



TrDelta®
 1" 1/4 4SP

PE 38 12 J N

- 240 t
- +38 mm
- 118 mm



TrDelta®
 2" 4 SP
 1" 6SP

PE 58 14J N | PE 58 14J 5.5 N

- 350 t
- +54 mm
- 180 mm



TrDelta®
 2" 6 SP
 3" 2 SP

Accesorios para prensas · Accessories for crimping machines



MACHINES & ACCESSORIES

Máquinas y Accesorios
Bearbeitungsmaschinen und Zubehör
Machines et Accessoires

CHMT-20 N

Ø Max. 50mm

2,2 Kw

Ø 250 mm



TrAde®
1" 1/4 4SP

CHM4-32 N

Ø Max. 75mm

3 Kw

Ø 250 mm



TrAde®
2" 4SP

HOSE CUTTING BLADES

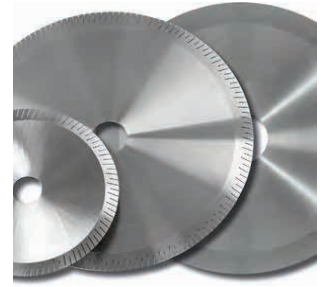

Disponibles múltiples perfiles de discos
Available several profiles blades

PB-32N

2"

R.P.M. 300

0.75 Kw



TrAde®
2"

Útiles / Tools



Portaherramientas
Tool holder

PMT 2

2"



Peladora Manual
Manual hose skiving

PRO7

Carga máx.
recomendada /
bandeja: 70 Kg.

Carga total
recomendada:
490 Kg.

Each holder max
70 kg

Total max.
capacity: 490 kg



PCM3

Carga máx. rollo:
35 Kg.

Each roll max 35 kg



¡PERSONALIZA
TUS
MÁQUINAS!

CUSTOMIZE
YOUR
MACHINES!

YOUR
LOGO

DESCUBRE NUESTRO
CATÁLOGO DE MÁQUINAS



DISCOVER OUR MACHINE
CATALOGUE

ROLLER

Roller
Roller
Roller

Roller retráctil Inox

Stainless Steel Retractable Roller

Roller rétractable Acier Inox

Roller retrattile Inox

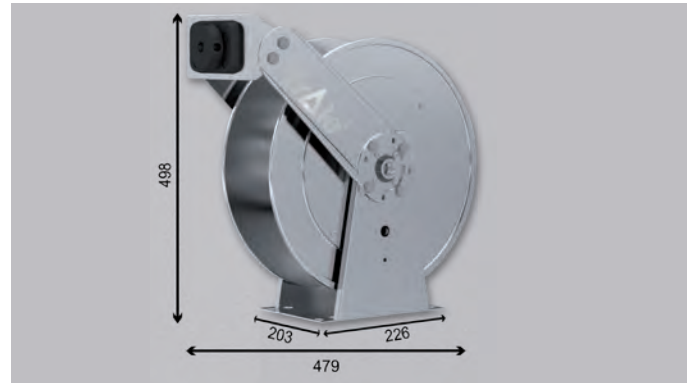

THREAD ROSCA	PRESSURE (bar) PRESION (bar)	MAX HOSE LENGHT LONG. MAX MANG.		Part n° Referencia	€
3/8" BSP	180	15 m - DN 3/8"	NEW	ZRRHG06	*
1/2" BSP	180	15 m - DN 1/2"	NEW	ZRRHG08	*

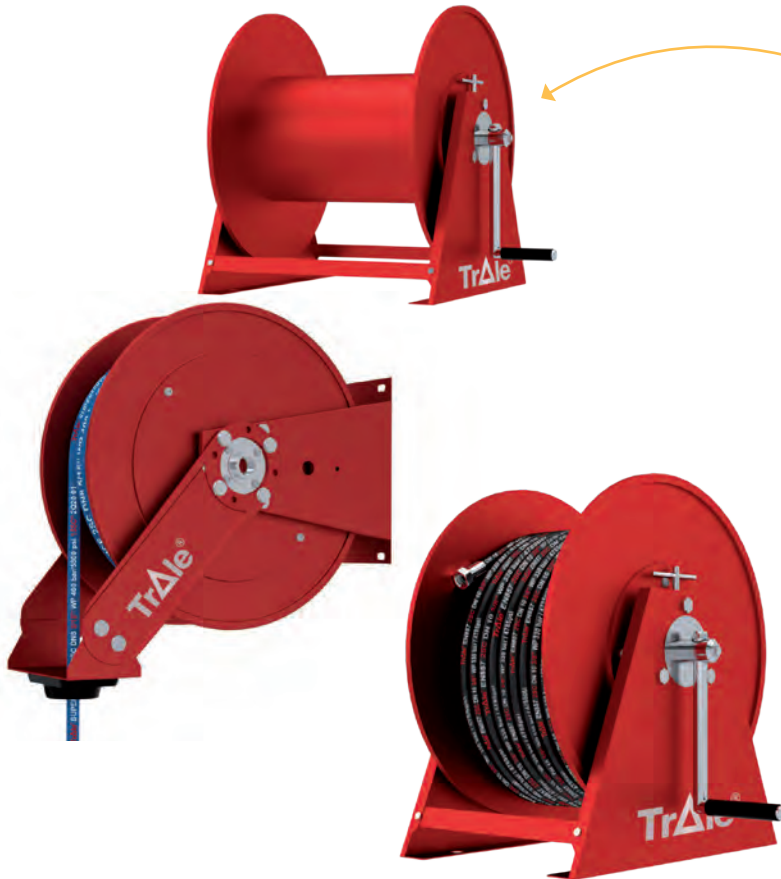
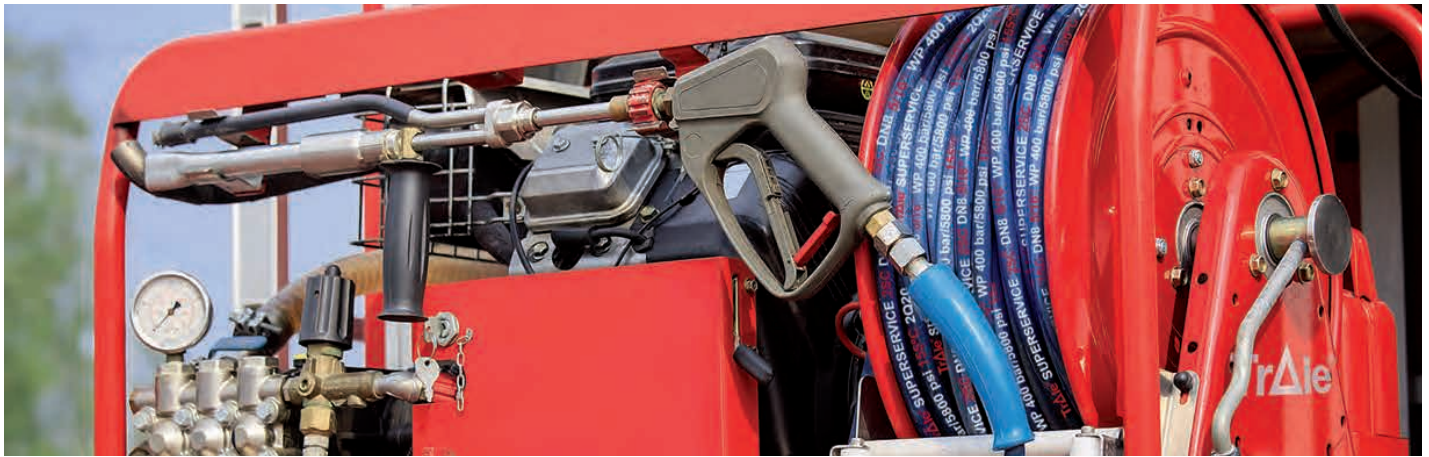





**MÁS
MODELOS
EN ACERO
CARBONO**



Carbon Steel Hose
Reels Also Available

MACHINES & ACCESSORIES

Máquinas y Accesorios
 Bearbeitungsmaschinen und Zubehör
 Machines et Accessoires

S01

 50
  0,18 Kw
  Ø 6-42 mm
  30 kg

Útiles de desbarbado incluidos
Deburring tools included

USFL/01 MAN

 6 → 42 x 4 mm



DIN 2353 **JIC 37°**

USFL/01

 6 → 42 x 4 mm
  0,75 Kw



DIN 2353 **JIC 37°**

M18 6-18

 6 → 18 mm



Manual bending machine
Dobladora manual



CMS42

 6 → 42 x 4 mm



With tool-holder cabinet
Con soporte

C42

 6 → 42 x 4 mm
  1.1 Kw



Electric bending machine with cabinet
Dobladora eléctrica con mueble

Útiles para las máquinas de doblado y montaje de racores · Pipe fittings for bending & assembly Machines

CUC42



Matrices de doblado
Bending tools

FT37



Matrices JIC 37°
Tools JIC 37°

BL

JIC 37°



Bloque BL JIC 37°
BL Block JIC 37°

PLT + SU

DIN 2353



Machos y matrices DIN 2353
Sockets & plates DIN 2353



CEN-MINI

 1.7 Kw max.
 210 kg.
Mini Mini





Pequeño y económico
Small & inexpensive

CEN-JU

 4.6 Kw max.
 300 kg.
 Mc
Completo



 220 l/min.
AIR

Con corte & aire comprimido
With cutting & compressed air

TRΔLE® METRIC PIPE | **108**

Tubo TrΔle® métrico
Metrisches Rohr TrΔle®
Tube rigide TrΔle® métrique

DIN 2353 PIPE FITTINGS | **109**

Racores DIN 2353
Verschraubungen Din 2353
Raccords à bague DIN 2353

FLARE FITTINGS JIC 37° | **131**

Racores JIC 37°
JIC - Verbindungen
Adapteurs JIC 37°

02



PIPE FITTINGS

Tubo Rígido TrAle®
Verschraubugen für Rohr
Raccord tube rigide



TrAle®



RACORES FABRICADOS POR
PIPE FITTINGS MANUFACTURED BY

DICSA

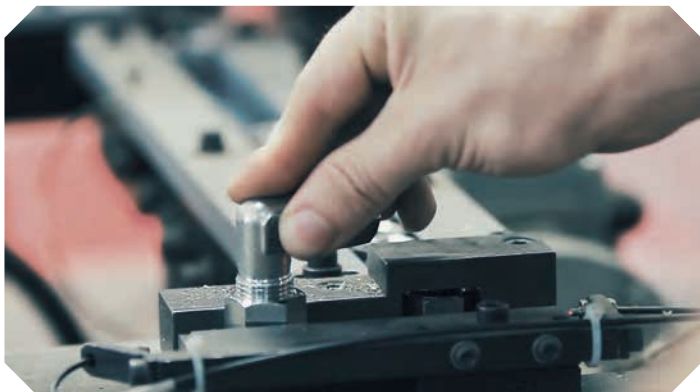

Assembly of the pipe fittings DIN 2353 in the rigid pipe (It is recommended to use pre-assembly tools)

Instrucciones de montaje del racor DIN 2353 sobre el tubo rígido (se recomienda el uso de herramientas de premontaje)
 Die Montage der Rohrverschraubungen DIN 2353 in dem Rohr (mit Pre-Montagewerkzeuge empfohlen)
 Instructions de montage du raccord DIN 2353 sur le tube rigide (Nous recommandons l'utilisation d'outils)

Minimun Height(H): twice the length of the thread					Minimun Height(L): 2,5 - 3 times the length of the thread																			
Series Ø ext. Pipe	LL				L												S							
	4	5	6	8	6	8	10	12	15	18	22	28	35	42	6	8	10	12	14	16	20	25	30	38
H min.	LL				L												S							
	24	25	25	26	31	31	33	33	36	38	42	42	48	48	35	35	37	37	43	43	50	54	58	65
L min.	LL				L												S							
	30	32	32	33	39	39	42	42	45	48	53	53	60	60	44	44	47	47	54	54	63	68	73	82

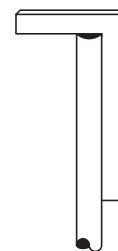
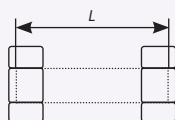
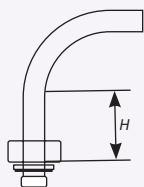

A. Rectangulary saw off the pipe and remove all burrs.
 Cortar el tubo a escuadra y eliminar rebabas.
 Das Rohr rechteckige schneiden und entfernen Sie alle Grate.
 Couper le tube à angle droit et entever les bavures.

B. Lubricate property
 Lubricar adecuadamente
 Richtig schmieren
 Lubrifier convenablement



C. Assembly
 Montaje
 Montage
 Montage



D. Blocking
 Apriete
 Andrücken
 Blockage

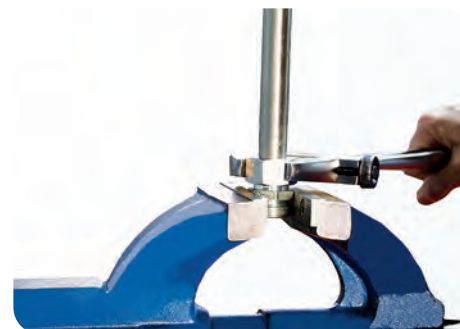

E. Control
 Control
 Kontrolle
 Control

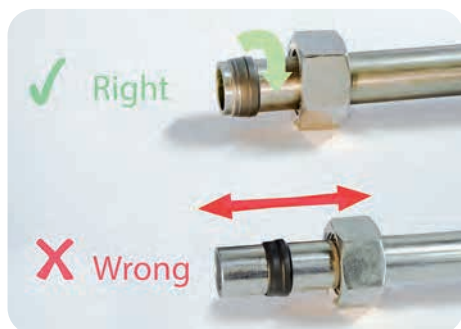

F. Final assembly
 Montaje final
 Endmontage
 Montage final



G. Later assemblies
 Montajes posteriores
 Letzten Montagen
 Montages posterieurs



TRΔLE® METRIC PIPE

Tubo TrΔle® métrico
Metrisches Rohr TrΔle®
Tube rigide TrΔle® métrique

Metric ▪ Métrico ▪ Metrisches ▪ Métrique

| 108



ZTH0



ZTH0...-3

DIN 2353 PIPE FITTINGS

Racores DIN 2353
Verschraubungen Din 2353
Raccords à bague DIN 2353

Nuts and cutting rings ▪ Tuercas y anillos ▪ Muttern und Schneidringe ▪ Écrous et bagues | 109



ZML/ZMS ZACL/ZACS ZVHS ZACJ

Straight couplings ▪ Uniones tubo-tubo ▪ Gerade Verschraubungen (G) ▪ Raccords union double | 112



ZDL/ZDS ZEL/ZES ZDL/ZDS ZTL/ZTS ZKVL/ZKVS

Straight male stud couplings ▪ Uniones rectas tubo-rosca ▪ Gerade Einschraubverschr. - EVGE ▪ Raccords union simple mâle | 114



ZAL/ZAS RC ZAL/ZAS BSP WD ZAL/ZAS BSP ZAL/ZAS M WD ZAL/ZAS UNF ZAKL/ZAKS NPT ZAKL/ZAKS BSPT ZAKL/ZAKS METRIC

Male stud elbows ▪ Codos tubo-rosca ▪ W-Einschraubverschraubungen - WE ▪ Raccords coude mâle gaz | 117



ZCKL/ZCKS BSPT Z WEE ZCKL/ZCKS NPT ZCKL/ZCKS METRIC

Male stud barrel ▪ TES rosca lateral ▪ L-Einschraubverschraubungen - LE ▪ Raccords Té mâle latéral | 118



ZLKL/ZLKS BSPT ZLKL/ZLKS METRIC

Male stud branch ▪ TES rosca central ▪ T-Einschraubungen - TE ▪ Raccords Té mâle central | 119



ZFKL/ZFKS BSPT ZFKL/ZFKS METRIC ZFKL/ZFKS NPT

Metric unions ▪ Uniones Métricas ▪ Metr. Verschraubungen ▪ Raccords union Métrique | 120



ZKORL TLM ZKORS TLM

Reductions ▪ Reducciones roscadas ▪ Reduzierstutzen ▪ Raccords de réduction | 121



ZRI-R WD

Adjustable stud couplings ▪ Racores regulables ▪ Einstellbare Verschraubungen - EV ▪ Raccords réglables | 122



ZEEL/ZEES CTA ZEEL/ZEES TLM ZTEL/ZTES TLM ZLEL/ZLES TLM

DIN 2353 PIPE FITTINGS

Racores DIN 2353
Verschraubungen Din 2353
Raccords à bague DIN 2353

Adjustable straight stud ▪ Tubo roscado (hembra giratoria) ▪ Einstellbarer gerader Einschraubstutzen - EV ▪ Raccords tube fileté | 123



ZATL/ZATS ZRAL/ZRASBSPTLMWD ZRAL/ZRAS NPT TLM ZRAL/ZRAS METRIC TLMWD

Welding fittings ▪ Soldables ▪ Schweißarmaturen ▪ Raccords à souder | 124



ZASL/ZASS ZESVL/ZESVS ZORIL/ZORIS

Bulkhead ▪ Pasatabiques ▪ Schottverschraubungen - SV ▪ Raccords passe cloison | 125



ZSVL/ZSVS ZUSVL/ZUSVS KZTPM

Straight female coupling ▪ Racor recto hembra ▪ Gerade Aufschraub-Versch. - GAI ▪ Raccords droits femelle | 126



ZGAIL/ZGAIS BSP ZMAVL/ZMAVS ZGAIL/ZGAIS METRIC ZAM

Banjos ▪ Orientables ▪ Ringaugen ▪ Raccords orientables | 127



ZWSVL/ZWSVS BSP ZWSVL/ZWSVS METRIC

Plugs ▪ Tapones ▪ Stopfen ▪ Raccords bouchon métrique | 128



ZBUTZEN L/S ZSTOPFEN BSP ZSTOPFEN METRIC

O-rings & captive seals ▪ Juntas ▪ Dichtringe - DOZ ▪ Joints | 128



JVT JVBSP/JVM

Accessories for the assembly ▪ Accesorios para montaje ▪ Zubehör für die Montage ▪ Accessoires pour le montage | 129



ZVOMO Grasa

Valves ▪ Válvulas antirretorno ▪ Rückschlagventil - RV ▪ Valves clapet antiretour | 130



ZRHVL/ZRHVS ZRHZL/ZRHZS ZRHDL/ZRHDS

FLARE FITTINGS JIC 37°

Racores JIC 37°
JIC - Verbindungen
Adapteurs JIC 37°

JIC 37° Nuts, sleeves and plugs ▪ Tuercas, ferulas y tapones JIC 37° ▪ Ü-Muttern, Druckringe und Verschlussstopfen JIC ▪ Écrous, ferrules et bouchons JIC 37°

131



ZS110

ZS120

ZS121

ZS140

ZS130

JIC 37° Straight unions ▪ Uniones rectas JIC 37° ▪ gerade JIC-Verschraubungen ▪ Union droite JIC 37°

132



ZS260

ZS260

ZS250

ZS260_OR

ZS240

ZS200

ZS380

ZS230

ZS180

ZS210

ZS295

ZS740

ZS291

ZS290

ZS185

JVMET

JVUNF

ZS730

JMBSP

JTVJIC

JIC 37° 90° Elbows ▪ Codos 90° JIC 37° ▪ 90° Winkel JIC 37° ▪ Coudes 90° JIC 37°

137



ZS500

ZS675

ZS700

ZS500_OR

ZS650

ZS570

ZS575

ZS550

ZS595

ZS525

JIC 37° 45° Elbows ▪ Codos 45 JIC 37° ▪ 45° Winkel JIC 37° ▪ Coudes 45° JIC 37°

139



ZS690

ZS775

ZS725

JIC 37° Tees ▪ Tes JIC 37° ▪ T-Verschraubungen JIC 37° ▪ Tés JIC 37°

140



ZS505

ZS680

ZS630

ZS505_OR

ZS685

ZS625

TRΔLE® METRIC PIPE

Tubo TrΔle® métrico
Metrisches Rohr TrΔle®
Tube rigide TrΔle® métrique

Rigid pipe - 6 mts

Tubo rígido - 6 mts

Rohr - 6m

Tube rigide - 6 mts

**Rigid pipe - 3 mts**

Tubo rígido - 3 mts

Rohr - 3m

Tube rigide - 3 mts



Ø EXT. Ø OUTER	Ø INT. Ø INNER	Referencia Part n°	€/M
4	2	ZTH0040100	5,06
6	4	ZTH0060100	8,04
6	3	NEW ZTH0060150	7,97
8	6	ZTH0080100	10,28
8	5	NEW ZTH0080150	13,42
10	8	ZTH0100100	12,30
10	7	ZTH0100150	18,18
10	6	NEW ZTH0100200	18,96
12	10	ZTH0120100	13,56
12	9	ZTH0120150	18,60
12	8	NEW ZTH0120200	27,33
12	7	NEW ZTH0120250	34,31
14	10	ZTH0140200	27,01
15	12	ZTH0150150	24,61
16	12	ZTH0160200	36,35
16	10	NEW ZTH0160300	34,18
18	15	ZTH0180150	31,60
18	14	ZTH0180200	40,83
20	14	ZTH0200300	60,82
22	18	ZTH0220200	46,98
25	19	ZTH0250300	77,32
28	24	ZTH0280200	60,26
30	24	ZTH0300300	77,18
35	31	ZTH0350200	75,01
38	30	ZTH0380400	128,01
42	38	NEW ZTH0420200	76,37
42	36	ZTH0420300	121,92

Ø EXT. Ø OUTER	Ø INT. Ø INNER	Referencia Part n°	€/M
4	2	ZTH0040100-3	5,32
6	4	ZTH0060100-3	8,45
6	3	NEW ZTH0060150-3	8,37
8	6	ZTH0080100-3	10,79
8	5	NEW ZTH0080150-3	14,09
10	8	ZTH0100100-3	12,92
10	7	ZTH0100150-3	19,08
12	10	ZTH0120100-3	14,24
10	6	NEW ZTH0100200-3	19,91
12	9	ZTH0120150-3	19,53
12	8	NEW ZTH0120200-3	28,70
12	7	NEW ZTH0120250-3	36,03
14	10	ZTH0140200-3	28,36
15	12	ZTH0150150-3	25,84
16	12	ZTH0160200-3	38,17
16	10	NEW ZTH0160300-3	35,89
18	15	ZTH0180150-3	33,18
18	14	ZTH0180200-3	42,87
20	14	ZTH0200300-3	63,86
22	18	ZTH0220200-3	49,33
25	19	ZTH0250300-3	81,18
28	24	ZTH0280200-3	63,27
30	24	ZTH0300300-3	81,04
35	31	ZTH0350200-3	78,76
38	30	ZTH0380400-3	134,41
42	38	NEW ZTH0420200-3	80,19
42	36	ZTH0420300-3	128,02

TUBO SCHEDULE PIPE

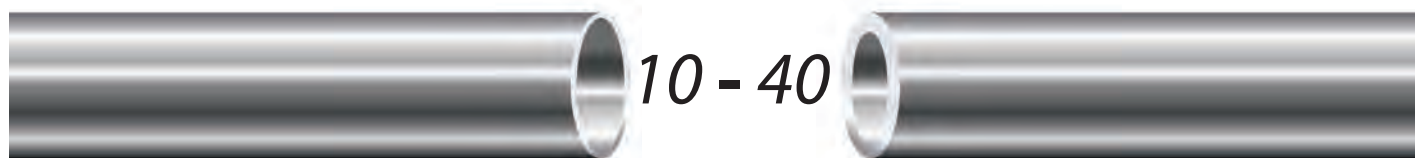

PÁGINA | PAGE
149

Consulta en nuestra ficha técnica datos | Check our technical sheet for data

DIN 2353 PIPE FITTINGS

Racores DIN 2353
Verschraubungen Din 2353
Raccords à bague DIN 2353

Nuts DIN 3870

Tuercas Métricas DIN 3870

Muttern DIN 3870 (M)

Écrou DIN 3870



TUBO PIPE	SERIE SERIES	ROSCA THREAD	Referencia Part n°	€
4	LL	M8X1	Z MLL 4	3,40
6	LL	M10X1	Z MLL 6	3,12
8	LL	M12X1	Z MLL 8	3,64
6	L	M12X1.5	Z ML 6	2,13
8	L	M14X1.5	Z ML 8	2,64
10	L	M16X1.5	Z ML 10	3,04
12	L	M18X1.5	Z ML 12	3,65
15	L	M22X1.5	Z ML 15	5,28
18	L	M26X1.5	Z ML 18	8,21
22	L	M30X2	Z ML 22	10,66
28	L	M36X2	Z ML 28	21,93
35	L	M45X2	Z ML 35	36,67
42	L	M52X2	Z ML 42	45,78
6	S	M14X1.5	Z MS 6	2,87
8	S	M16X1.5	Z MS 8	3,23
10	S	M18X1.5	Z MS 10	4,05
12	S	M20X1.5	Z MS 12	4,49
14	S	M22X1.5	Z MS 14	7,31
16	S	M24X1.5	Z MS 16	8,12
20	S	M30X2	Z MS 20	12,38
25	S	M36X2	Z MS 25	29,22
30	S	M42X2	Z MS 30	37,58
38	S	M52X2	Z MS 38	57,15

Cutting rings DIN 3861

Anillos de corte DIN 3861

Schneidringe DIN 3861 (D)

Bague DIN 3861



TUBO PIPE	SERIE SERIES	Referencia Part n°	€
4	LL	Z ACLL 4	2,04
6	LL	Z ACLL 6	2,24
8	LL	Z ACLL 8	2,32
6	L/S	Z ACL 6	2,05
8	L/S	Z ACL 8	2,11
10	L/S	Z ACL 10	2,70
12	L/S	Z ACL 12	2,81
15	L	Z ACL 15	3,09
18	L	Z ACL 18	3,37
22	L	Z ACL 22	4,50
28	L	Z ACL 28	6,75
35	L	Z ACL 35	10,32
42	L	Z ACL 42	12,05
14	S	Z ACS 14	3,53
16	S	Z ACS 16	3,83
20	S	Z ACS 20	4,50
25	S	Z ACS 25	6,75
30	S	Z ACS 30	10,12
38	S	Z ACS 38	10,89

Reinforced ring

Anillos de refuerzo

Verstärkungsring

Bague de renforcement



TUBO PIPE	Referencia Part n°	€
4	Z VHS 4	*
5	Z VHS 5	*
6	Z VHS 6	*
7	Z VHS 7	*
8	Z VHS 8	*
9	Z VHS 9	*
10	Z VHS 10	*
11	Z VHS 11	*
12	Z VHS 12	*
13	Z VHS 13	*
14	Z VHS 14	*
15	Z VHS 15	*
16	Z VHS 16	*
17	Z VHS 17	*
18	Z VHS 18	*
19	Z VHS 19	*
20	Z VHS 20	*
22	Z VHS 22	*
24	Z VHS 24	*
25	Z VHS 25	*
31	Z VHS 31	*
33	Z VHS 33	*
38	Z VHS 38	*

DIN 2353 PIPE FITTINGS

Racores DIN 2353
Verschraubungen Din 2353
Raccords à bague DIN 2353

Cutting ring with joint

Anillos de corte con junta

Schneidring mit Dichtung

Bague avec joint



TUBO PIPE	SERIE SERIES	Referencia Part n°	€
6	L	Z ACJL 6	5,04
8	L	Z ACJL 8	5,16
10	L	Z ACJL 10	5,81
12	L	Z ACJL 12	4,94
15	L	Z ACJL 15	8,23
18	L	Z ACJL 18	10,29
22	L	Z ACJL 22	11,76
28	L	Z ACJL 28	16,85
35	L	Z ACJL 35	24,95
42	L	Z ACJL 42	31,20
6	S	Z ACJS 6	5,15
8	S	Z ACJS 8	5,19
10	S	Z ACJS 10	5,85
12	S	Z ACJS 12	6,65
14	S	Z ACJS 14	8,10
16	S	Z ACJS 16	9,33
20	S	Z ACJS 20	12,32
25	S	Z ACJS 25	16,55
30	S	Z ACJS 30	21,70
38	S	Z ACJS 38	31,31

■ Asegura una completa estanqueidad con el anillo de corte con junta

■ Ensure the right tightening with our cutting ring with joint

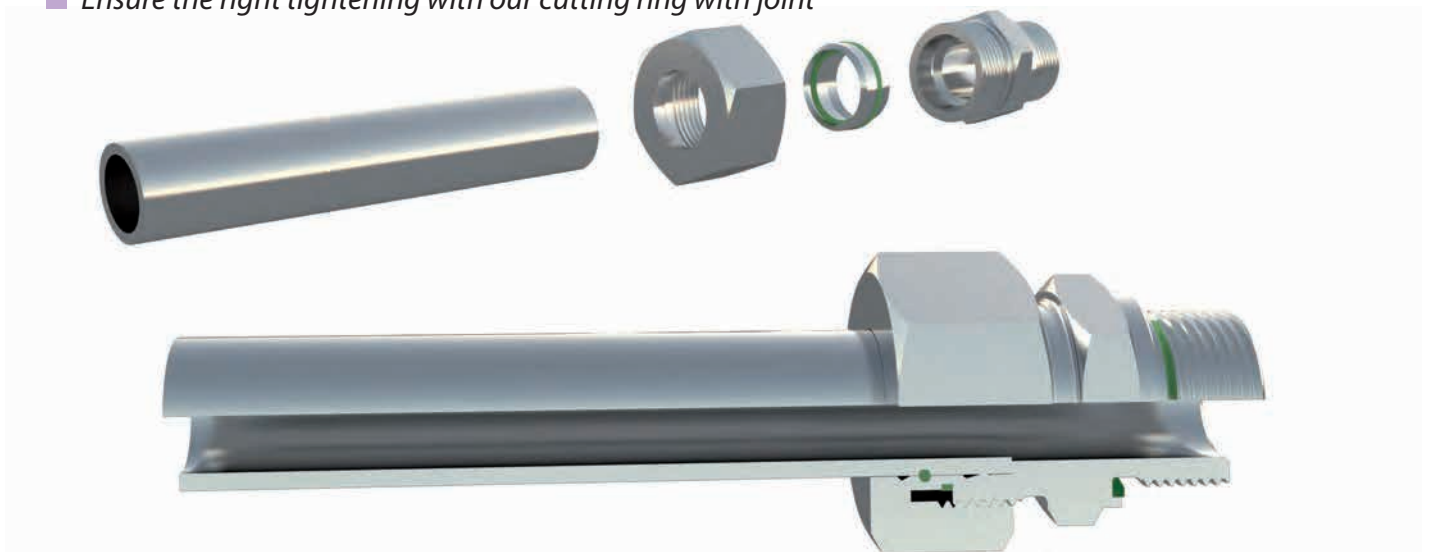

Consulta en nuestra ficha técnica datos | Check our technical sheet for data

**Ø FUGAS EN EQUIPAMIENTOS
SOMETIDOS A ALTAS VIBRACIONES**



**Ø LEAKS IN EQUIPMENT
SUBJECTED TO HIGH VIBRATIONS**



USOS MÁS EXIGENTES HIGH DEMANDING APPLICATIONS

**BAJO CONSULTA
ON REQUEST**

NEW

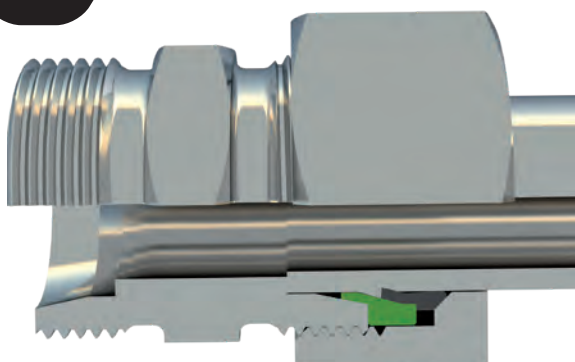

- ‡ **Hasta una presión nominal (PN) de 800 bar**
- ‡ **Reducción de los pares de apriete en hasta 25%**
- ‡ **Un montaje aún más sencillo**
- ‡ **Sencillo manejo mediante tuerca funcional**

- ‡ **Pressure rating up to 800 bar (PN)**
- ‡ **Reduction of tightening torques up to 25%**
- ‡ **Easier assembly**
- ‡ **Simple handling through functional nut**

DIN 2353 PIPE FITTINGS

Racores DIN 2353
Verschraubungen Din 2353
Raccords à bague DIN 2353

Straight coupling

Racor unión recta tubo - tubo

Gerade Verschraubungen (G)

Raccord union double



TUBO PIPE	SERIE SERIES	Referencia Part n°	€	Referencia STA Part N° STA	€
4	LL	Z DLL 4	26,35	---	*
6	LL	Z DLL 6	23,09	---	*
8	LL	Z DLL 8	22,29	---	*
6	L	Z DL 6	15,61	Z STA DL 6	7,02
8	L	Z DL 8	15,32	Z STA DL 8	8,78
10	L	Z DL 10	16,95	Z STA DL 10	10,13
12	L	Z DL 12	20,88	Z STA DL 12	10,46
15	L	Z DL 15	27,82	Z STA DL 15	13,84
18	L	Z DL 18	35,86	Z STA DL 18	16,47
22	L	Z DL 22	43,98	Z STA DL 22	25,00
28	L	Z DL 28	76,33	Z STA DL 28	40,54
35	L	Z DL 35	114,55	Z STA DL 35	55,40
42	L	Z DL 42	168,30	Z STA DL 42	86,46
6	S	Z DS 6	18,91	Z STA DS 6	10,81
8	S	Z DS 8	20,53	Z STA DS 8	9,61
10	S	Z DS 10	24,71	Z STA DS 10	13,46
12	S	Z DS 12	27,84	Z STA DS 12	17,48
14	S	Z DS 14	34,50	Z STA DS 14	21,61
16	S	Z DS 16	34,38	Z STA DS 16	17,73
20	S	Z DS 20	55,39	Z STA DS 20	29,05
25	S	Z DS 25	95,21	Z STA DS 25	47,28
30	S	Z DS 30	127,90	Z STA DS 30	60,79
38	S	Z DS 38	193,24	Z STA DS 38	79,69

Equal elbow coupling

Racor unión en codo tubo - tubo

Winkel-Verschraubungen (W)

Raccord coude égal



TUBO PIPE	SERIE SERIES	Referencia Part n°	€	Referencia STA Part N° STA	€
4	LL	Z ELL 4	39,27	---	*
6	LL	Z ELL 6	34,86	---	*
8	LL	Z ELL 8	37,82	---	*
6	L	Z EL 6	24,22	Z STA EL 6	17,32
8	L	Z EL 8	22,36	Z STA EL 8	21,11
10	L	Z EL 10	25,46	Z STA EL 10	24,32
12	L	Z EL 12	31,02	Z STA EL 12	25,67
15	L	Z EL 15	43,12	Z STA EL 15	33,78
18	L	Z EL 18	60,81	Z STA EL 18	45,93
22	L	Z EL 22	86,46	Z STA EL 22	65,27
28	L	Z EL 28	130,80	Z STA EL 28	99,71
35	L	Z EL 35	202,37	Z STA EL 35	157,89
42	L	Z EL 42	290,22	Z STA EL 42	244,50
6	S	Z ES 6	26,45	Z STA ES 6	23,38
8	S	Z ES 8	28,80	Z STA ES 8	26,00
10	S	Z ES 10	32,96	Z STA ES 10	27,01
12	S	Z ES 12	41,41	Z STA ES 12	30,49
14	S	Z ES 14	51,30	Z STA ES 14	37,82
16	S	Z ES 16	63,14	Z STA ES 16	43,23
20	S	Z ES 20	87,73	Z STA ES 20	66,77
25	S	Z ES 25	147,30	Z STA ES 25	99,05
30	S	Z ES 30	205,46	Z STA ES 30	152,81
38	S	Z ES 38	312,62	Z STA ES 38	220,18

Straight reducing coupling

Racor unión recta en reducción tubo - tubo

Gerade Reduzierschraubungen (GR)

Raccord union double en réduction



TUBO PIPE	PIPE	SERIE SERIES	Referencia Part n°	€	Referencia STA Part N° STA	€
8	6	L	Z DL 8-6	20,08	Z STA DL 8-6	10,83
10	6	L	Z DL 10-6	21,18	Z STA DL 10-6	10,94
10	8	L	Z DL 10-8	20,25	Z STA DL 10-8	9,44
12	6	L	Z DL 12-6	23,85	Z STA DL 12-6	12,89
12	8	L	Z DL 12-8	24,61	Z STA DL 12-8	12,85
12	10	L	Z DL 12-10	23,95	Z STA DL 12-10	10,43
15	6	L	Z DL 15-6	36,75	Z STA DL 15-6	23,88
15	8	L	Z DL 15-8	40,54	Z STA DL 15-8	25,00
15	10	L	Z DL 15-10	30,06	Z STA DL 15-10	15,63
15	12	L	Z DL 15-12	28,80	Z STA DL 15-12	14,27
18	8	L	Z DL 18-8	45,11	Z STA DL 18-8	28,47
18	10	L	Z DL 18-10	38,48	Z STA DL 18-10	20,86
18	12	L	Z DL 18-12	39,07	Z STA DL 18-12	20,72
18	15	L	Z DL 18-15	40,84	Z STA DL 18-15	23,46
22	12	L	Z DL 22-12	51,94	Z STA DL 22-12	30,00
22	15	L	Z DL 22-15	50,37	Z STA DL 22-15	26,52
22	18	L	Z DL 22-18	54,39	Z STA DL 22-18	27,34
28	22	L	Z DL 28-22	93,02	Z STA DL 28-22	48,86
35	22	L	Z DL 35-22 *	97,17	Z STA DL 35-22 *	40,59
35	28	L	Z DL 35-28	129,45	Z STA DL 35-28	84,44
42	28	L	Z DL 42-28	172,90	Z STA DL 42-28	86,07
42	35	L	Z DL 42-35	161,34	Z STA DL 42-35	102,93
8	6	S	Z DS 8-6	28,33	Z STA DS 8-6	18,09
10	6	S	Z DS 10-6	27,84	Z STA DS 10-6	17,52
10	8	S	Z DS 10-8	30,82	Z STA DS 10-8	20,01
12	6	S	Z DS 12-6	36,35	Z STA DS 12-6	23,82
12	8	S	Z DS 12-8	30,85	Z STA DS 12-8	17,89
12	10	S	Z DS 12-10	33,29	Z STA DS 12-10	18,93
14	10	S	Z DS 14-10	39,37	Z STA DS 14-10	21,47
16	10	S	Z DS 16-10	46,33	Z STA DS 16-10	28,23
16	12	S	Z DS 16-12	41,60	Z STA DS 16-12	22,03
16	14	S	Z DS 16-14	48,43	Z STA DS 16-14	25,34
20	12	S	Z DS 20-12	63,36	Z STA DS 20-12	41,13
20	14	S	Z DS 20-14	73,36	Z STA DS 20-14	45,78
20	16	S	Z DS 20-16	65,48	Z STA DS 20-16	36,34
25	16	S	Z DS 25-16	100,88	Z STA DS 25-16	52,65
25	20	S	Z DS 25-20	107,07	Z STA DS 25-20	53,90
30	20	S	Z DS 30-20	142,36	Z STA DS 30-20	77,47
30	25	S	Z DS 30-25	153,38	Z STA DS 30-25	99,15
38	25	S	Z DS 38-25	191,47	Z STA DS 38-25	91,32
38	30	S	Z DS 38-30	232,03	Z STA DS 38-30	115,98

*Until end of stock / Hasta fin de existencias / Bis zum Ende des Lagerbestandes / Jusqu'à la fin du stock

DIN 2353 PIPE FITTINGS

Racores DIN 2353
Verschraubungen Din 2353
Raccords à bague DIN 2353

Equal Tee

Racor unión en T tubo - tubo

T-Verschraubungen (T)

Raccord Té égal



TUBO PIPE	SERIE SERIES	Referencia Part n°	€	Referencia STA Part N° STA	€
4	LL	Z TLL 4	50,75	---	*
6	LL	Z TLL 6	51,32	---	*
8	LL	Z TLL 8	56,06	---	*
6	L	Z TL 6	31,04	Z STA TL 6	22,83
8	L	Z TL 8	32,55	Z STA TL 8	26,35
10	L	Z TL 10	36,83	Z STA TL 10	28,23
12	L	Z TL 12	41,64	Z STA TL 12	30,39
15	L	Z TL 15	56,43	Z STA TL 15	43,09
18	L	Z TL 18	81,32	Z STA TL 18	56,75
22	L	Z TL 22	116,85	Z STA TL 22	80,93
28	L	Z TL 28	168,33	Z STA TL 28	127,31
35	L	Z TL 35	298,03	Z STA TL 35	229,64
42	L	Z TL 42	405,32	Z STA TL 42	303,94
6	S	Z TS 6	35,02	Z STA TS 6	31,58
8	S	Z TS 8	37,91	Z STA TS 8	32,60
10	S	Z TS 10	44,43	Z STA TS 10	32,42
12	S	Z TS 12	54,95	Z STA TS 12	43,23
14	S	Z TS 14	84,04	Z STA TS 14	54,13
16	S	Z TS 16	82,04	Z STA TS 16	56,75
20	S	Z TS 20	114,98	Z STA TS 20	84,09
25	S	Z TS 25	197,25	Z STA TS 25	134,67
30	S	Z TS 30	303,18	Z STA TS 30	205,08
38	S	Z TS 38	417,67	Z STA TS 38	243,27

Equal cross

Racor unión en cruz tubo - tubo

Kreuz-Verschraubungen (K)

Raccord croix égale

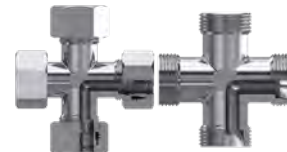

TUBO PIPE	SERIE SERIES	Referencia Part n°	€	Referencia STA Part N° STA	€
6	L	Z KVL 6	67,78	Z STA KVL 6	59,26
8	L	Z KVL 8	70,36	Z STA KVL 8	60,47
10	L	Z KVL 10	97,99	Z STA KVL 10	85,14
12	L	Z KVL 12	85,11	Z STA KVL 12	68,42
15	L	Z KVL 15	137,04	Z STA KVL 15	121,59
18	L	Z KVL 18	146,55	Z STA KVL 18	132,57
22	L	Z KVL 22	193,53	Z STA KVL 22	159,86
28	L	Z KVL 28	238,00	Z STA KVL 28	175,19
35	L	Z KVL 35	682,58	Z STA KVL 35	494,23
42	L	Z KVL 42	664,00	Z STA KVL 42	494,95
6	S	Z KVS 6	79,69	Z STA KVS 6	59,64
8	S	Z KVS 8	80,58	Z STA KVS 8	70,27
10	S	Z KVS 10	91,39	Z STA KVS 10	74,47
12	S	Z KVS 12	113,82	Z STA KVS 12	94,46
14	S	Z KVS 14	189,37	Z STA KVS 14	145,65
16	S	Z KVS 16	154,13	Z STA KVS 16	120,76
20	S	Z KVS 20	194,36	Z STA KVS 20	155,27
25	S	Z KVS 25	284,05	Z STA KVS 25	161,44
30	S	Z KVS 30	448,90	Z STA KVS 30	257,73
38	S	Z KVS 38	670,43	Z STA KVS 38	447,32

DIN 2353 PIPE FITTINGS

Racores DIN 2353
Verschraubungen Din 2353
Raccords à bague DIN 2353

Straight male stud coupling BSP cyl. 60°

Racor recto rosca cilíndrica BSP cono 60°

Gerade Einschraubverschr. zyl. BSP kon. 60°

Raccord Union simple mâle gaz cylindrique 60°



Straight male stud coupling BSP cylindrical with captive seal

Racor recto rosca cilíndrica BSP con junta

Gerade Einschraubverschr. mit Flachdichtung BSP ZYL - GE-R-ED

Raccord union simple mâle gaz cylindrique avec joint plat



TUBO PIPE	ROSCA THREAD	SERIE SERIES	Referencia Part n°	€	Referencia STA Part N° STA	€
6	1/8" BSP	L	Z AL 6 RC 1/8	9,27	Z STA AL 6 RC 1/8	6,24
6	1/4" BSP	L	Z AL 6 RC 1/4	14,05	Z STA AL 6 RC 1/4	11,60
6	3/8" BSP	L	Z AL 6 RC 3/8	27,14	Z STA AL 6 RC 3/8	22,80
6	1/2" BSP	L	Z AL 6 RC 1/2	38,42	Z STA AL 6 RC 1/2	34,08
8	1/8" BSP	L	Z AL 8 RC 1/8	17,60	Z STA AL 8 RC 1/8	12,69
8	1/4" BSP	L	Z AL 8 RC 1/4	15,78	Z STA AL 8 RC 1/4	10,87
8	3/8" BSP	L	Z AL 8 RC 3/8	19,21	Z STA AL 8 RC 3/8	14,30
8	1/2" BSP	L	Z AL 8 RC 1/2	32,07	Z STA AL 8 RC 1/2	27,16
10	1/8" BSP	L	Z AL 10 RC 1/8	14,80	Z STA AL 10 RC 1/8	9,16
10	1/4" BSP	L	Z AL 10 RC 1/4	13,54	Z STA AL 10 RC 1/4	7,86
10	3/8" BSP	L	Z AL 10 RC 3/8	17,18	Z STA AL 10 RC 3/8	13,43
10	1/2" BSP	L	Z AL 10 RC 1/2	23,10	Z STA AL 10 RC 1/2	17,20
12	1/4" BSP	L	Z AL 12 RC 1/4	15,70	Z STA AL 12 RC 1/4	10,97
12	3/8" BSP	L	Z AL 12 RC 3/8	15,07	Z STA AL 12 RC 3/8	11,44
12	1/2" BSP	L	Z AL 12 RC 1/2	20,92	Z STA AL 12 RC 1/2	14,63
15	3/8" BSP	L	Z AL 15 RC 3/8	21,30	Z STA AL 15 RC 3/8	14,82
15	1/2" BSP	L	Z AL 15 RC 1/2	22,12	Z STA AL 15 RC 1/2	14,62
15	3/4" BSP	L	Z AL 15 RC 3/4	35,38	Z STA AL 15 RC 3/4	26,85
18	1/2" BSP	L	Z AL 18 RC 1/2	34,15	Z STA AL 18 RC 1/2	22,66
18	3/4" BSP	L	Z AL 18 RC 3/4	34,48	Z STA AL 18 RC 3/4	25,05
22	3/8" BSP	L	Z AL 22 RC 3/8	44,46	Z STA AL 22 RC 3/8	29,14
22	1/2" BSP	L	Z AL 22 RC 1/2	46,82	Z STA AL 22 RC 1/2	31,50
22	3/4" BSP	L	Z AL 22 RC 3/4	37,48	Z STA AL 22 RC 3/4	22,65
22	1" BSP	L	Z AL 22 RC 1	53,59	Z STA AL 22 RC 1	38,27
28	3/4" BSP	L	Z AL 28 RC 3/4	59,54	Z STA AL 28 RC 3/4	31,43
28	1" BSP	L	Z AL 28 RC 1	63,06	Z STA AL 28 RC 1	34,22
35	1" 1/4 BSP	L	Z AL 35 RC 1 1/4	123,56	Z STA AL 35 RC 1 1/4	76,41
35	1" 1/2 BSP	L	Z AL 35 RC 1 1/2	114,20	Z STA AL 35 RC 1 1/2	68,00
42	1" 1/4 BSP	L	Z AL 42 RC 1 1/4	151,46	Z STA AL 42 RC 1 1/4	93,47
42	1" 1/2 BSP	L	Z AL 42 RC 1 1/2	137,73	Z STA AL 42 RC 1 1/2	79,74
6	1/4" BSP	S	Z AS 6 RC 1/4	24,30	Z STA AS 6 RC 1/4	19,23
6	3/8" BSP	S	Z AS 6 RC 3/8	20,07	Z STA AS 6 RC 3/8	15,00
8	1/4" BSP	S	Z AS 8 RC 1/4	15,70	Z STA AS 8 RC 1/4	10,81
8	3/8" BSP	S	Z AS 8 RC 3/8	19,15	Z STA AS 8 RC 3/8	13,64
8	1/2" BSP	S	Z AS 8 RC 1/2	34,51	Z STA AS 8 RC 1/2	29,01
10	1/4" BSP	S	Z AS 10 RC 1/4	17,67	Z STA AS 10 RC 1/4	11,30
10	3/8" BSP	S	Z AS 10 RC 3/8	27,74	Z STA AS 10 RC 3/8	20,83
10	1/2" BSP	S	Z AS 10 RC 1/2	34,53	Z STA AS 10 RC 1/2	27,62
12	1/4" BSP	S	Z AS 12 RC 1/4	24,02	Z STA AS 12 RC 1/4	16,70
12	3/8" BSP	S	Z AS 12 RC 3/8	22,31	Z STA AS 12 RC 3/8	14,86
12	1/2" BSP	S	Z AS 12 RC 1/2	27,69	Z STA AS 12 RC 1/2	20,23
14	3/8" BSP	S	Z AS 14 RC 3/8	39,45	Z STA AS 14 RC 3/8	28,46
14	1/2" BSP	S	Z AS 14 RC 1/2	37,81	Z STA AS 14 RC 1/2	26,82
16	3/8" BSP	S	Z AS 16 RC 3/8	30,16	Z STA AS 16 RC 3/8	23,93
16	1/2" BSP	S	Z AS 16 RC 1/2	27,16	Z STA AS 16 RC 1/2	17,38
16	3/4" BSP	S	Z AS 16 RC 3/4	42,88	Z STA AS 16 RC 3/4	30,78
20	3/8" BSP	S	Z AS 20 RC 3/8	48,44	Z STA AS 20 RC 3/8	31,56
20	1/2" BSP	S	Z AS 20 RC 1/2	40,60	Z STA AS 20 RC 1/2	25,80
20	3/4" BSP	S	Z AS 20 RC 3/4	48,39	Z STA AS 20 RC 3/4	31,36
20	1" BSP	S	Z AS 20 RC 1	67,62	Z STA AS 20 RC 1	50,59
25	3/4" BSP	S	Z AS 25 RC 3/4	78,11	Z STA AS 25 RC 3/4	41,98
25	1" BSP	S	Z AS 25 RC 1	79,92	Z STA AS 25 RC 1	43,79
25	1" 1/4 BSP	S	Z AS 25 RC 1 1/4	114,80	Z STA AS 25 RC 1 1/4	78,67
30	1" BSP	S	Z AS 30 RC 1	114,12	Z STA AS 30 RC 1	66,26
30	1" 1/4 BSP	S	Z AS 30 RC 1 1/4	131,76	Z STA AS 30 RC 1 1/4	83,91
30	1" 1/2 BSP	S	Z AS 30 RC 1 1/2	112,59	Z STA AS 30 RC 1 1/2	73,20
38	1" 1/4 BSP	S	Z AS 38 RC 1 1/4	155,19	Z STA AS 38 RC 1 1/4	86,99
38	1" 1/2 BSP	S	Z AS 38 RC 1 1/2	167,19	Z STA AS 38 RC 1 1/2	99,00

TUBO PIPE	SERIE SERIES	ROSCA THREAD	Referencia Part n°	€	Referencia STA Part N° STA	€
6	L	1/8" BSP	Z AL 6 R 1/8WD	12,16	Z STA AL 6 R 1/8WD	10,59
6	L	1/4" BSP	Z AL 6 R 1/4WD	15,26	Z STA AL 6 R 1/4WD	12,72
6	L	3/8" BSP	Z AL 6 R 3/8WD	18,13	Z STA AL 6 R 3/8WD	13,79
8	L	1/8" BSP	Z AL 8 R 1/8WD	14,63	Z STA AL 8 R 1/8WD	11,32
8	L	1/4" BSP	Z AL 8 R 1/4WD	14,69	Z STA AL 8 R 1/4WD	10,60
8	L	3/8" BSP	Z AL 8 R 3/8WD	17,20	Z STA AL 8 R 3/8WD	14,37
8	L	1/2" BSP	Z AL 8 R 1/2WD	22,89	Z STA AL 8 R 1/2WD	17,98
10	L	1/8" BSP	Z AL 10 R 1/8WD	16,70	Z STA AL 10 R 1/8WD	15,16
10	L	1/4" BSP	Z AL 10 R 1/4WD	15,83	Z STA AL 10 R 1/4WD	11,63
10	L	3/8" BSP	Z AL 10 R 3/8WD	17,41	Z STA AL 10 R 3/8WD	15,29
10	L	1/2" BSP	Z AL 10 R 1/2WD	22,71	Z STA AL 10 R 1/2WD	20,35
12	L	1/4" BSP	Z AL 12 R 1/4WD	17,61	Z STA AL 12 R 1/4WD	13,89
12	L	3/8" BSP	Z AL 12 R 3/8WD	17,77	Z STA AL 12 R 3/8WD	13,70
12	L	1/2" BSP	Z AL 12 R 1/2WD	21,80	Z STA AL 12 R 1/2WD	18,29
15	L	3/8" BSP	Z AL 15 R 3/8WD	24,62	Z STA AL 15 R 3/8WD	17,88
15	L	1/2" BSP	Z AL 15 R 1/2WD	25,22	Z STA AL 15 R 1/2WD	16,70
15	L	3/4" BSP	Z AL 15 R 3/4WD	33,04	Z STA AL 15 R 3/4WD	24,95
18	L	3/8" BSP	Z AL 18 R 3/8WD	39,18	Z STA AL 18 R 3/8WD	27,45
18	L	1/2" BSP	Z AL 18 R 1/2WD	27,15	Z STA AL 18 R 1/2WD	16,55
18	L	3/4" BSP	Z AL 18 R 3/4WD	35,77	Z STA AL 18 R 3/4WD	27,51
22	L	1/2" BSP	Z AL 22 R 1/2WD	44,79	Z STA AL 22 R 1/2WD	29,47
22	L	3/4" BSP	Z AL 22 R 3/4WD	34,60	Z STA AL 22 R 3/4WD	22,09
22	L	1" BSP	Z AL 22 R 1WD	53,29	Z STA AL 22 R 1WD	40,42
28	L	3/4" BSP	Z AL 28 R 3/4WD	63,92	Z STA AL 28 R 3/4WD	38,61
28	L	1" BSP	Z AL 28 R 1WD	57,41	Z STA AL 28 R 1WD	34,17
35	L	1" BSP	Z AL 35 R 1WD	103,70	Z STA AL 35 R 1WD	56,55
35	L	1" 1/4 BSP	Z AL 35 R 1 1/4WD	94,59	Z STA AL 35 R 1 1/4WD	67,69
42	L	1" 1/2 BSP	Z AL 42 R 1 1/2WD	126,58	Z STA AL 42 R 1 1/2WD	73,58
6	S	1/4" BSP	Z AS 6 R 1/4WD	21,49	Z STA AS 6 R 1/4WD	16,57
8	S	1/4" BSP	Z AS 8 R 1/4WD	18,26	Z STA AS 8 R 1/4WD	14,52
8	S	3/8" BSP	Z AS 8 R 3/8WD	22,93	Z STA AS 8 R 3/8WD	18,10
8	S	1/2" BSP	Z AS 8 R 1/2WD	29,05	Z STA AS 8 R 1/2WD	23,55
10	S	1/4" BSP	Z AS 10 R 1/4WD	19,53	Z STA AS 10 R 1/4WD	15,68
10	S	3/8" BSP	Z AS 10 R 3/8WD	24,25	Z STA AS 10 R 3/8WD	19,32
10	S	1/2" BSP	Z AS 10 R 1/2WD	32,80	Z STA AS 10 R 1/2WD	25,90
12	S	1/4" BSP	Z AS 12 R 1/4WD	26,38	Z STA AS 12 R 1/4WD	19,82
12	S	3/8" BSP	Z AS 12 R 3/8WD	21,13	Z STA AS 12 R 3/8WD	13,67
12	S	1/2" BSP	Z AS 12 R 1/2WD	27,98	Z STA AS 12 R 1/2WD	23,60
14	S	3/8" BSP	Z AS 14 R 3/8WD	34,74	Z STA AS 14 R 3/8WD	27,68
14	S	1/2" BSP	Z AS 14 R 1/2WD	30,23	Z STA AS 14 R 1/2WD	23,04
16	S	3/8" BSP	Z AS 16 R 3/8WD	30,84	Z STA AS 16 R 3/8WD	20,80
16	S	1/2" BSP	Z AS 16 R 1/2WD	29,81	Z STA AS 16 R 1/2WD	19,10
16	S	3/4" BSP	Z AS 16 R 3/4WD	37,44	Z STA AS 16 R 3/4WD	27,62
20	S	1/2" BSP	Z AS 20 R 1/2WD	39,46	Z STA AS 20 R 1/2WD	26,96
20	S	3/4" BSP	Z AS 20 R 3/4WD	39,55	Z STA AS 20 R 3/4WD	26,61
25	S	3/4" BSP	Z AS 25 R 3/4WD	66,98	Z STA AS 25 R 3/4WD	47,42
25	S	1" BSP	Z AS 25 R 1WD	68,65	Z STA AS 25 R 1WD	53,47
25	S	1" 1/4 BSP	Z AS 25 R 1 1/4WD	114,91	Z STA AS 25 R 1 1/4WD	78,78
30	S	1" BSP	Z AS 30 R 1WD	98,28	Z STA AS 30 R 1WD	50,43
30	S	1" 1/4 BSP	Z AS 30 R 1 1/4WD	109,18	Z STA AS 30 R 1 1/4WD	67,00
30	S	1" 1/2 BSP	Z AS 30 R 1 1/2WD	168,86	Z STA AS 30 R 1 1/2WD	121,01
38	S	1" 1/4 BSP	Z AS 38 R 1 1/4WD	151,29	Z STA AS 38 R 1 1/4WD	94,25
38	S	1" 1/2 BSP	Z AS 38 R 1 1/2WD	147,76	Z STA AS 38 R 1 1/2WD	84,84

DIN 2353 PIPE FITTINGS

Racores DIN 2353
Verschraubungen Din 2353
Raccords à bague DIN 2353

Straight male stud coupling BSP cylindrical

Racor recto rosca cilíndrica BSP

Gerade Einschraubverschr. BSP 60°
Innenkonus – GE-R

Raccord union simple gaz cylindrique mâle

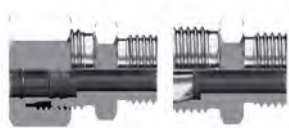

TUBO PIPE	SERIE SERIES	ROSCA THREAD	Referencia Part n°	€	Referencia STA Part N° STA	€
10	L	1/8" BSP	Z AL 10 R 1/8	14,80	---	*
15	L	3/4" BSP	Z AL 15 R 3/4	29,11	---	*
18	L	1/2" BSP	Z AL 18 R 1/2	25,25	Z STA AL 18 R 1/2	20,26
6	S	1/4" BSP	Z AS 6 R 1/4	18,51	Z STA AS 6 R 1/4	13,43
6	S	3/8" BSP	Z AS 6 R 3/8	20,07	---	*
8	S	1/4" BSP	Z AS 8 R 1/4	15,10	Z STA AS 8 R 1/4	11,01
8	S	1/2" BSP	Z AS 8 R 1/2	27,25	---	*
10	S	1/4" BSP	Z AS 10 R 1/4	16,99	Z STA AS 10 R 1/4	12,16
10	S	3/8" BSP	Z AS 10 R 3/8	17,40	Z STA AS 10 R 3/8	13,34
10	S	1/2" BSP	Z AS 10 R 1/2	31,74	Z STA AS 10 R 1/2	17,85
12	S	1/4" BSP	Z AS 12 R 1/4	20,88	Z STA AS 12 R 1/4	16,06
14	S	1/2" BSP	Z AS 14 R 1/2	26,56	Z STA AS 14 R 1/2	19,00
30	S	1" 1/2 BSP	Z AS 30 R 1 1/2	130,29	---	*
38	S	1" 1/4 BSP	Z AS 38 R 1 1/4	127,89	Z STA AS 38 R 1 1/4	86,04

Until end of stock / Hasta fin de existencias / Bis zum Ende des Lagerbestandes / Jusqu'à la fin du stock

Straight male stud coupling Metric cylindrical with captive seal

Racor recto rosca cilíndrica Métrica con junta

Gerade metr. Einschraubverschr. mit Flachdichtung GE-M-ED

Raccord union simple mâle cylindrique Métrique avec joint plat



TUBO PIPE	SERIE SERIES	ROSCA THREAD	Referencia Part n°	€	Referencia STA Part N° STA	€
6	L	M10x1	Z AL 6 M 10X1 WD	11,98	Z STA AL 6 M 10X1 WD	8,17
8	L	M12x1.5	Z AL 8 M 12X1.5 WD	16,73	Z STA AL 8 M 12X1.5 WD	12,09
10	L	M12x1.5	Z AL 10 M 12X1.5 WD	22,21	Z STA AL 10 M 12X1.5 WD	16,31
10	L	M14x1.5	Z AL 10 M 14X1.5 WD	21,64	Z STA AL 10 M 14X1.5 WD	16,34
10	L	M16x1.5	Z AL 10 M 16X1.5 WD	21,87	Z STA AL 10 M 16X1.5 WD	15,97
12	L	M16x1.5	Z AL 12 M 16X1.5 WD	23,98	Z STA AL 12 M 16X1.5 WD	17,57
12	L	M18x1.5	Z AL 12 M 18X1.5 WD	21,64	Z STA AL 12 M 18X1.5 WD	16,46
12	L	M22x1.5	Z AL 12 M 22X1.5 WD	28,66	Z STA AL 12 M 22X1.5 WD	24,18
15	L	M18x1.5	Z AL 15 M 18X1.5 WD	31,46	Z STA AL 15 M 18X1.5 WD	22,94
18	L	M22x1.5	Z AL 18 M 22X1.5 WD	37,52	Z STA AL 18 M 22X1.5 WD	25,79
22	L	M26x1.5	Z AL 22 M 26X1.5 WD	47,95	Z STA AL 22 M 26X1.5 WD	32,64
28	L	M33x2	Z AL 28 M 33X2 WD	67,61	Z STA AL 28 M 33X2 WD	40,72
35	L	M42x2	Z AL 35 M 42X2 WD	113,46	Z STA AL 35 M 42X2 WD	66,31
42	L	M48x2	Z AL 42 M 48X2 WD	154,00	Z STA AL 42 M 48X2 WD	96,01
6	S	M12x1.5	Z AS 6 M 12X1.5 WD	25,00	Z STA AS 6 M 12X1.5 WD	19,92
6	S	M14x1.5	Z AS 6 M 14X1.5 WD	24,71	Z STA AS 6 M 14X1.5 WD	19,63
8	S	M14x1.5	Z AS 8 M 14X1.5 WD	27,70	Z STA AS 8 M 14X1.5 WD	22,20
10	S	M16x1.5	Z AS 10 M 16X1.5 WD	26,75	Z STA AS 10 M 16X1.5 WD	19,84
12	S	M14x1.5	Z AS 12 M 14X1.5 WD	28,36	Z STA AS 12 M 14X1.5 WD	20,91
12	S	M18x1.5	Z AS 12 M 18X1.5 WD	25,61	Z STA AS 12 M 18X1.5 WD	20,50
14	S	M20x1.5	Z AS 14 M 20X1.5 WD	39,51	Z STA AS 14 M 20X1.5 WD	28,52
16	S	M22x1.5	Z AS 16 M 22X1.5 WD	37,58	Z STA AS 16 M 22X1.5 WD	26,85
20	S	M27x2	Z AS 20 M 27X2 WD	50,74	Z STA AS 20 M 27X2 WD	33,70
25	S	M33x2	Z AS 25 M 33X2 WD	85,24	Z STA AS 25 M 33X2 WD	49,12
30	S	M42x2	Z AS 30 M 42X2 WD	112,11	Z STA AS 30 M 42X2 WD	64,26
38	S	M48x2	Z AS 38 M 48X2 WD	162,07	Z STA AS 38 M 48X2 WD	93,88

Straight male stud coupling UNF

Racor recto rosca UNF

Gerade Einschraubverschr. UNF

Raccord union simple mâle UNF

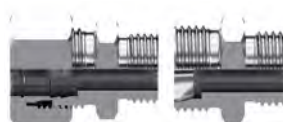

TUBO PIPE	SERIE SERIES	ROSCA THREAD	Referencia Part n°	€	Referencia STA Part N° STA	€
8	L	7/16" UNF	Z AL 8 7/16 UNF	25,17	Z STA AL 8 7/16 UNF	20,26
10	L	7/16" UNF	Z AL 10 7/16 UNF	26,77	Z STA AL 10 7/16 UNF	20,87
12	L	3/4" UNF	Z AL 12 3/4 UNF	27,83	Z STA AL 12 3/4 UNF	21,22
12	L	9/16" UNF	Z AL 12 9/16 UNF	23,76	Z STA AL 12 9/16 UNF	17,14
15	L	3/4" UNF	Z AL 15 3/4 UNF	37,48	Z STA AL 15 3/4 UNF	28,95
18	L	7/8" UNF	Z AL 18 7/8 UNF	38,52	Z STA AL 18 7/8 UNF	26,79
22	L	1" 1/16 UNF	Z AL 22 1 1/16 UNF	47,41	Z STA AL 22 1 1/16 UNF	32,09
28	L	1" 5/16 UNF	Z AL 28 1 5/16 UNF	76,15	Z STA AL 28 1 5/16 UNF	48,38
35	L	1" 5/8 UNF	Z AL 35 1 5/8 UNF	136,42	Z STA AL 35 1 5/8 UNF	89,27
8	S	7/16" UNF	Z AS 8 7/16 UNF	24,10	Z STA AS 8 7/16 UNF	18,59
10	S	9/16" UNF	Z AS 10 9/16 UNF	26,35	Z STA AS 10 9/16 UNF	19,45
12	S	9/16" UNF	Z AS 12 9/16 UNF	28,08	Z STA AS 12 9/16 UNF	21,49
16	S	3/4" UNF	Z AS 16 3/4 UNF	42,02	Z STA AS 16 3/4 UNF	29,92
20	S	7/8" UNF	Z AS 20 7/8 UNF	57,91	Z STA AS 20 7/8 UNF	40,87
30	S	1" 5/16 UNF	Z AS 30 1 5/16 UNF	125,01	Z STA AS 30 1 5/16 UNF	77,15
25	S	1" 5/16 UNF	Z AS 25 1 5/16 UNF	95,75	Z STA AS 25 1 5/16 UNF	99,90
38	S	1" 5/8 UNF	Z AS 38 1 5/8 UNF	206,88	Z STA AS 38 1 5/8 UNF	138,68

DIN 2353 PIPE FITTINGS

Racores DIN 2353
Verschraubungen Din 2353
Raccords à bague DIN 2353

Straight male stud coupling NPT

Racor recto rosca cónica NPT

Gerade Einschraubversch. NPT - EVGE-NPT

Raccord union simple mâle NPT



TUBO PIPE	SERIE SERIES	ROSCA THREAD	Referencia Part n°	€	Referencia STA Part N° STA	€
6	L	1/8"NPT	Z AKL 6 1/8 NPT	12,75	Z STA AKL 6 1/8 NPT	9,95
6	L	1/4"NPT	Z AKL 6 1/4 NPT	18,79	Z STA AKL 6 1/4 NPT	15,06
6	L	3/8"NPT	Z AKL 6 3/8 NPT	20,53	Z STA AKL 6 3/8 NPT	16,19
8	L	1/8"NPT	Z AKL 8 1/8 NPT	13,91	Z STA AKL 8 1/8 NPT	10,75
8	L	1/4"NPT	Z AKL 8 1/4 NPT	14,65	Z STA AKL 8 1/4 NPT	10,79
8	L	3/8"NPT	Z AKL 8 3/8 NPT	19,09	Z STA AKL 8 3/8 NPT	14,67
8	L	1/2"NPT	Z AKL 8 1/2 NPT	22,31	Z STA AKL 8 1/2 NPT	17,40
10	L	1/4"NPT	Z AKL 10 1/4 NPT	15,24	Z STA AKL 10 1/4 NPT	11,11
10	L	3/8"NPT	Z AKL 10 3/8 NPT	18,48	Z STA AKL 10 3/8 NPT	12,59
10	L	1/2"NPT	Z AKL 10 1/2 NPT	25,13	Z STA AKL 10 1/2 NPT	20,48
12	L	1/4"NPT	Z AKL 12 1/4 NPT	17,37	Z STA AKL 12 1/4 NPT	14,03
12	L	3/8"NPT	Z AKL 12 3/8 NPT	19,20	Z STA AKL 12 3/8 NPT	14,36
12	L	1/2"NPT	Z AKL 12 1/2 NPT	20,79	Z STA AKL 12 1/2 NPT	16,23
15	L	3/8"NPT	Z AKL 15 3/8 NPT	26,03	Z STA AKL 15 3/8 NPT	20,13
15	L	1/2"NPT	Z AKL 15 1/2 NPT	26,78	Z STA AKL 15 1/2 NPT	20,17
18	L	1/2"NPT	Z AKL 18 1/2 NPT	33,32	Z STA AKL 18 1/2 NPT	25,39
18	L	3/4"NPT	Z AKL 18 3/4 NPT	41,94	Z STA AKL 18 3/4 NPT	30,21
22	L	3/4"NPT	Z AKL 22 3/4 NPT	43,94	Z STA AKL 22 3/4 NPT	28,62
28	L	1"NPT	Z AKL 28 1 NPT	68,14	Z STA AKL 28 1 NPT	39,30
35	L	1"1/4NPT	Z AKL 35 1 1/4 NPT	96,41	Z STA AKL 35 1 1/4 NPT	49,26
42	L	1"1/2NPT	Z AKL 42 1 1/2 NPT	141,82	Z STA AKL 42 1 1/2 NPT	84,33
6	S	1/8"NPT	Z AKS 6 1/8 NPT	20,69	Z STA AKS 6 1/8 NPT	15,61
6	S	1/4"NPT	Z AKS 6 1/4 NPT	18,13	Z STA AKS 6 1/4 NPT	13,16
6	S	3/8"NPT	Z AKS 6 3/8 NPT	25,67	Z STA AKS 6 3/8 NPT	21,33
8	S	1/4"NPT	Z AKS 8 1/4 NPT	19,03	Z STA AKS 8 1/4 NPT	13,88
8	S	3/8"NPT	Z AKS 8 3/8 NPT	28,36	Z STA AKS 8 3/8 NPT	22,86
8	S	1/2"NPT	Z AKS 8 1/2 NPT	25,60	Z STA AKS 8 1/2 NPT	20,10
10	S	1/4"NPT	Z AKS 10 1/4 NPT	22,23	Z STA AKS 10 1/4 NPT	15,32
10	S	3/8"NPT	Z AKS 10 3/8 NPT	21,87	Z STA AKS 10 3/8 NPT	14,96
10	S	1/2"NPT	Z AKS 10 1/2 NPT	27,55	Z STA AKS 10 1/2 NPT	20,67
12	S	1/4"NPT	Z AKS 12 1/4 NPT	25,74	Z STA AKS 12 1/4 NPT	18,28
12	S	3/8"NPT	Z AKS 12 3/8 NPT	26,63	Z STA AKS 12 3/8 NPT	19,17
12	S	1/2"NPT	Z AKS 12 1/2 NPT	27,08	Z STA AKS 12 1/2 NPT	19,63
14	S	1/2"NPT	Z AKS 14 1/2 NPT	35,12	Z STA AKS 14 1/2 NPT	25,64
16	S	1/2"NPT	Z AKS 16 1/2 NPT	33,62	Z STA AKS 16 1/2 NPT	26,23
16	S	3/4"NPT	Z AKS 16 3/4 NPT	39,85	Z STA AKS 16 3/4 NPT	27,74
20	S	1/2"NPT	Z AKS 20 1/2 NPT	49,39	Z STA AKS 20 1/2 NPT	32,35
20	S	3/4"NPT	Z AKS 20 3/4 NPT	61,99	Z STA AKS 20 3/4 NPT	47,48
20	S	1"NPT	Z AKS 20 1 NPT	70,57	Z STA AKS 20 1 NPT	53,54
25	S	3/4"NPT	Z AKS 25 3/4 NPT	91,55	Z STA AKS 25 3/4 NPT	55,42
25	S	1"NPT	Z AKS 25 1 NPT	82,25	Z STA AKS 25 1 NPT	47,47
30	S	1"NPT	Z AKS 30 1 NPT	126,44	Z STA AKS 30 1 NPT	80,61
30	S	1"1/4NPT	Z AKS 30 1 1/4 NPT	111,73	Z STA AKS 30 1 1/4 NPT	63,87
38	S	1"1/2NPT	Z AKS 38 1 1/2 NPT	156,97	Z STA AKS 38 1 1/2 NPT	93,28

Straight male stud coupling BSPT

Racor recto rosca cónica BSPT

Gerade Einschraubversch. kegelig - GE-BSPT

Raccord union simple mâle conique



TUBO PIPE	SERIE SERIES	ROSCA THREAD	Referencia Part n°	€	Referencia STA Part N° STA	€
6	LL	1/8" BSPT	Z AKLL 6 R 1/8	*	---	*
8	LL	1/8" BSPT	Z AKLL 8 R 1/8	*	---	*
6	L	1/8" BSPT	Z AKL 6 R 1/8	12,15	Z STA AKL 6 R 1/8	9,26
6	L	1/4" BSPT	Z AKL 6 R 1/4	13,49	Z STA AKL 6 R 1/4	9,15
8	L	1/8" BSPT	Z AKL 8 R 1/8	15,21	Z STA AKL 8 R 1/8	10,30
8	L	1/4" BSPT	Z AKL 8 R 1/4	13,47	Z STA AKL 8 R 1/4	9,49
6	L	3/8" BSPT	Z AKL 6 R 3/8	21,50	Z STA AKL 6 R 3/8	17,16
8	L	3/8" BSPT	Z AKL 8 R 3/8	17,20	Z STA AKL 8 R 3/8	12,29
10	L	1/4" BSPT	Z AKL 10 R 1/4	14,46	Z STA AKL 10 R 1/4	10,63
10	L	3/8" BSPT	Z AKL 10 R 3/8	14,83	Z STA AKL 10 R 3/8	10,54
10	L	1/2" BSPT	Z AKL 10 R 1/2	21,06	Z STA AKL 10 R 1/2	15,16
12	L	1/4" BSPT	Z AKL 12 R 1/4	17,40	Z STA AKL 12 R 1/4	13,53
12	L	3/8" BSPT	Z AKL 12 R 3/8	16,25	Z STA AKL 12 R 3/8	13,39
12	L	1/2" BSPT	Z AKL 12 R 1/2	19,08	Z STA AKL 12 R 1/2	14,82
15	L	3/8" BSPT	Z AKL 15 R 3/8	25,15	Z STA AKL 15 R 3/8	18,92
15	L	1/2" BSPT	Z AKL 15 R 1/2	24,10	Z STA AKL 15 R 1/2	17,29
18	L	1/2" BSPT	Z AKL 18 R 1/2	27,96	Z STA AKL 18 R 1/2	19,29
22	L	3/4" BSPT	Z AKL 22 R 3/4	36,97	Z STA AKL 22 R 3/4	24,36
28	L	1" BSPT	Z AKL 28 R 1	63,75	Z STA AKL 28 R 1	48,38
35	L	1"1/4 BSPT	Z AKL 35 R 1 1/4	96,86	Z STA AKL 35 R 1 1/4	54,98
42	L	1"1/2 BSPT	Z AKL 42 R 1 1/4	115,07	Z STA AKL 42 R 1 1/4	64,29
6	S	1/4" BSPT	Z AKS 6 R 1/4	17,85	Z STA AKS 6 R 1/4	12,77
8	S	1/4" BSPT	Z AKS 8 R 1/4	16,57	Z STA AKS 8 R 1/4	11,88
10	S	3/8" BSPT	Z AKS 10 R 3/8	32,96	Z STA AKS 10 R 3/8	26,05
14	S	1/2" BSPT	Z AKS 14 R 1/2	62,37	Z STA AKS 14 R 1/2	51,38
16	S	1/2" BSPT	Z AKS 16 R 1/2	37,95	Z STA AKS 16 R 1/2	25,84
20	S	3/4" BSPT	Z AKS 20 R 3/4	54,08	Z STA AKS 20 R 3/4	37,04
25	S	1" BSPT	Z AKS 25 R 1	87,22	Z STA AKS 25 R 1	51,09
30	S	1"1/4 BSPT	Z AKS 30 R 1 1/4	209,93	Z STA AKS 30 R 1 1/4	162,08

Straight male stud coupling Metric

Racor recto rosca cónica Métrica

Gerade Einschraubversch. metr. kon.- EVGE-M (KEG)

Raccord union simple mâle Métrique conique



TUBO PIPE	SERIE SERIES	ROSCA THREAD	Referencia Part n°	€
6	LL	M10X1	Z AKLL 6 M10X1	16,21
6	L	M10X1	Z AKL 6 M 10X1	16,35
8	L	M12X1.5	Z AKL 8 M 12X1.5	21,08
10	L	M14X1.5	Z AKL 10 M 14X1.5	23,48
12	L	M16X1.5	Z AKL 12 M 16X1.5	25,67
15	L	M18X1.5	Z AKL 15 M 18X1.5	35,12
18	L	M22X1.5	Z AKL 18 M 22X1.5	45,93
22	L	M26X1.5	Z AKL 22 M 26X1.5	38,36

DIN 2353 PIPE FITTINGS

Racores DIN 2353
Verschraubungen Din 2353
Raccords à bague DIN 2353

Male stud elbow BSPT

Racor en codo rosca cónica BSPT

W-Einschraubverschr. BSPT kon. - WE-R (KEG)

Raccord union coude mâle gaz conique



TUBO PIPE	SERIE SERIES	ROSCA THREAD	Referencia Part n°	€	Referencia STA Part N° STA	€
6	LL	1/8" BSPT	Z CKLL 6 R 1/8	24,62	---	*
6	L	1/8" BSPT	Z CKL 6 R 1/8	19,30	Z STA CKL 6 R 1/8	14,96
6	L	1/4" BSPT	Z CKL 6 R 1/4	18,80	Z STA CKL 6 R 1/4	14,46
8	L	1/8" BSPT	Z CKL 8 R 1/8	22,76	Z STA CKL 8 R 1/8	19,89
8	L	1/4" BSPT	Z CKL 8 R 1/4	20,72	Z STA CKL 8 R 1/4	18,81
8	L	3/8" BSPT	Z CKL 8 R 3/8	27,79	Z STA CKL 8 R 3/8	24,21
8	L	1/2" BSPT	Z CKL 8 R 1/2	39,12	Z STA CKL 8 R 1/2	34,21
10	L	1/8" BSPT	Z CKL 10 R 1/8	32,64	Z STA CKL 10 R 1/8	31,66
10	L	1/4" BSPT	Z CKL 10 R 1/4	23,28	Z STA CKL 10 R 1/4	19,96
10	L	3/8" BSPT	Z CKL 10 R 3/8	24,41	Z STA CKL 10 R 3/8	21,51
10	L	1/2" BSPT	Z CKL 10 R 1/2	29,10	Z STA CKL 10 R 1/2	23,20
12	L	1/4" BSPT	Z CKL 12 R 1/4	27,72	Z STA CKL 12 R 1/4	22,17
12	L	3/8" BSPT	Z CKL 12 R 3/8	27,96	Z STA CKL 12 R 3/8	24,39
12	L	1/2" BSPT	Z CKL 12 R 1/2	31,00	Z STA CKL 12 R 1/2	30,35
15	L	3/8" BSPT	Z CKL 15 R 3/8	51,03	Z STA CKL 15 R 3/8	42,51
15	L	1/2" BSPT	Z CKL 15 R 1/2	40,47	Z STA CKL 15 R 1/2	31,95
18	L	1/2" BSPT	Z CKL 18 R 1/2	53,93	Z STA CKL 18 R 1/2	42,75
22	L	3/4" BSPT	Z CKL 22 R 3/4	89,72	Z STA CKL 22 R 3/4	77,17
28	L	1" BSPT	Z CKL 28 R 1	192,05	Z STA CKL 28 R 1	163,21
35	L	1 1/4" BSPT	Z CKL 35 R 1 1/4	333,80	Z STA CKL 35 R 1 1/4	286,65
6	S	1/4" BSPT	Z CKS 6 R 1/4	27,00	Z STA CKS 6 R 1/4	21,93
8	S	1/4" BSPT	Z CKS 8 R 1/4	27,18	Z STA CKS 8 R 1/4	23,30
8	S	3/8" BSPT	Z CKS 8 R 3/8	37,15	---	*
8	S	1/2" BSPT	Z CKS 8 R 1/2	37,01	Z STA CKS 8 R 1/2	31,51
10	S	1/4" BSPT	Z CKS 10 R 1/4	40,80	Z STA CKS 10 R 1/4	35,10
10	S	3/8" BSPT	Z CKS 10 R 3/8	32,69	Z STA CKS 10 R 3/8	25,78
10	S	1/2" BSPT	Z CKS 10 R 1/2	50,89	---	*
12	S	3/8" BSPT	Z CKS 12 R 3/8	38,98	Z STA CKS 12 R 3/8	33,34
14	S	1/2" BSPT	Z CKS 14 R 1/2	51,84	Z STA CKS 14 R 1/2	40,85
16	S	1/2" BSPT	Z CKS 16 R 1/2	61,23	Z STA CKS 16 R 1/2	49,12
20	S	3/4" BSPT	Z CKS 20 R 3/4	91,43	Z STA CKS 20 R 3/4	74,56
25	S	1" BSPT	Z CKS 25 R 1	159,48	Z STA CKS 25 R 1	134,28
30	S	1 1/4" BSPT	Z CKS 30 R 1 1/4	337,43	Z STA CKS 30 R 1 1/4	289,58
38	S	1 1/2" BSPT	Z CKS 38 R 1 1/2	404,10	Z STA CKS 38 R 1 1/2	357,01

*Until end of stock / Hasta fin de existencias / Bis zum Ende des Lagerbestandes / Jusqu'à la fin du stock

90° Adjustable male stud elbow BSP

Racor en codo orientable BSP

Einstellbare W-Verschr. BSP - SWVE-M-R

Coude orientable mâle BSP



TUBO PIPE	SERIE SERIES	ROSCA THREAD	Referencia Part n°	€	Referencia STA Part N° STA	€
6	L	1/8" BSP	Z WEE 6L R 1/8	22,63	Z STA WEE 6L R 1/8	21,00
8	L	1/4" BSP	Z WEE 8L R 1/4	32,78	Z STA WEE 8L R 1/4	30,90
10	L	1/4" BSP	Z WEE 10L R 1/4	36,48	Z STA WEE 10L R 1/4	33,27
12	L	3/8" BSP	Z WEE 12L R 3/8	47,78	Z STA WEE 12L R 3/8	45,00
15	L	1/2" BSP	Z WEE 15L R 1/2	88,93	Z STA WEE 15L R 1/2	87,40
18	L	1/2" BSP	Z WEE 18L R 1/2	90,72	Z STA WEE 18L R 1/2	90,58
22	L	3/4" BSP	Z WEE 22L R 3/4	119,39	Z STA WEE 22L R 3/4	106,12
16	S	1/2" BSP	Z WEE 16S R 1/2	84,82	Z STA WEE 16S R 1/2	78,88
20	S	3/4" BSP	Z WEE 20S R 3/4	128,06	Z STA WEE 20S R 3/4	120,38
25	S	1" BSP	Z WEE 25S R 1	198,50	Z STA WEE 25S R 1	182,73

Male stud elbow NPT

Racor en codo rosca cónica NPT

W-Einschraubverschr. NPT - WE-NPT kon

Raccord union coude mâle NPT



TUBO PIPE	SERIE SERIES	ROSCA THREAD	Referencia Part n°	€	Referencia STA Part N° STA	€
6	L	1/8" NPT	Z CKL 6 1/8 NPT	21,43	Z STA CKL 6 1/8 NPT	17,09
6	L	1/4" NPT	Z CKL 6 1/4 NPT	21,95	Z STA CKL 6 1/4 NPT	17,61
8	L	1/4" NPT	Z CKL 8 1/4 NPT	22,36	Z STA CKL 8 1/4 NPT	18,16
10	L	1/4" NPT	Z CKL 10 1/4 NPT	25,09	Z STA CKL 10 1/4 NPT	19,20
12	L	1/4" NPT	Z CKL 12 1/4 NPT	32,39	Z STA CKL 12 1/4 NPT	25,78
12	L	3/8" NPT	Z CKL 12 3/8 NPT	32,75	Z STA CKL 12 3/8 NPT	26,14
12	L	1/2" NPT	Z CKL 12 1/2 NPT	34,98	Z STA CKL 12 1/2 NPT	28,36
15	L	1/2" NPT	Z CKL 15 1/2 NPT	40,94	Z STA CKL 15 1/2 NPT	32,41
18	L	1/2" NPT	Z CKL 18 1/2 NPT	82,73	Z STA CKL 18 1/2 NPT	71,00
22	L	3/4" NPT	Z CKL 22 3/4 NPT	88,06	Z STA CKL 22 3/4 NPT	72,74
28	L	1" NPT	Z CKL 28 1 NPT	125,45	Z STA CKL 28 1 NPT	96,61
35	L	1 1/4" NPT	Z CKL 35 1 1/4 NPT	270,41	Z STA CKL 35 1 1/4 NPT	223,26
42	L	1 1/2" NPT	Z CKL 42 1 1/2 NPT	335,31	Z STA CKL 42 1 1/2 NPT	277,32
6	S	1/4" NPT	Z CKS 6 1/4 NPT	25,50	Z STA CKS 6 1/4 NPT	20,43
8	S	1/4" NPT	Z CKS 8 1/4 NPT	32,17	Z STA CKS 8 1/4 NPT	26,67
10	S	3/8" NPT	Z CKS 10 3/8 NPT	39,27	Z STA CKS 10 3/8 NPT	32,37
12	S	3/8" NPT	Z CKS 12 3/8 NPT	37,48	Z STA CKS 12 3/8 NPT	30,03
12	S	1/2" NPT	Z CKS 12 1/2 NPT	36,30	Z STA CKS 12 1/2 NPT	29,38
14	S	1/2" NPT	Z CKS 14 1/2 NPT	66,18	Z STA CKS 14 1/2 NPT	55,19
16	S	1/2" NPT	Z CKS 16 1/2 NPT	64,83	Z STA CKS 16 1/2 NPT	52,73
20	S	3/4" NPT	Z CKS 20 3/4 NPT	87,80	Z STA CKS 20 3/4 NPT	70,77
25	S	1" NPT	Z CKS 25 1 NPT	174,51	Z STA CKS 25 1 NPT	138,38
30	S	1 1/4" NPT	Z CKS 30 1 1/4 NPT	337,70	Z STA CKS 30 1 1/4 NPT	289,84
38	S	1 1/2" NPT	Z CKS 38 1 1/2 NPT	337,03	Z STA CKS 38 1 1/2 NPT	268,84

Male stud elbow metrical conical

Racor en codo rosca cónica Métrica

W-Einschraubverschr. metr. kon. - WE-M (KEG)

Raccord équerre mâle métrique



TUBO PIPE	SERIE SERIES	ROSCA THREAD	Referencia Part n°	€
6	L	M10X1	Z CKL 6 M 10X1	26,35
8	L	M12X1,5	Z CKL 8 M 12X1,5	33,95
10	L	M14X1,5	Z CKL 10 M 14X1,5	36,58
12	L	M16X1,5	Z CKL 12 M 16X1,5	42,47
15	L	M18X1,5	Z CKL 15 M 18X1,5	59,28
18	L	M22X1,5	Z CKL 18 M 22X1,5	68,21
6	S	M12X1,5	Z CKS 6 M 12X1,5	27,43
8	S	M14X1,5	Z CKS 8 M 14X1,5	49,23
10	S	M16X1,5	Z CKS 10 M 16X1,5	50,91
12	S	M18X1,5	Z CKS 12 M 18X1,5	52,10
14	S	M20X1,5	Z CKS 14 M 20X1,5	53,35
16	S	M22X1,5	Z CKS 16 M 22X1,5	100,84

DIN 2353 PIPE FITTINGS

Racores DIN 2353
Verschraubungen Din 2353
Raccords à bague DIN 2353

Male stud barrel TEE BSPT

Racor en L rosca cónica BSPT

L-Einschraubverschr. BSPT kon. (LR)

Raccord TÉ mâle gaz conique latéral



TUBO PIPE	SERIE SERIES	ROSCA THREAD	Referencia Part n°	€
6	L	1/8" BSPT	Z LKL 6 R 1/8	47,28
8	L	1/4" BSPT	Z LKL 8 R 1/4	49,97
10	L	1/4" BSPT	Z LKL 10 R 1/4	53,62
12	L	3/8" BSPT	Z LKL 12 R 3/8	56,75
15	L	1/2" BSPT	Z LKL 15 R 1/2	79,69
18	L	1/2" BSPT	Z LKL 18 R 1/2	131,29
6	S	1/4" BSPT	Z LKS 6 R 1/4	51,43
8	S	1/4" BSPT	Z LKS 8 R 1/4	56,91
10	S	3/8" BSPT	Z LKS 10 R 3/8	67,00
12	S	3/8" BSPT	Z LKS 12 R 3/8	71,43
14	S	1/2" BSPT	Z LKS 14 R 1/2	87,80
16	S	1/2" BSPT	Z LKS 16 R 1/2	110,76

Male stud barrel TEE Metric

Racor en L rosca cónica Métrica

L-Einschraubverschr. metr. kon. (LM)

Raccord Té mâle Métrique latéral



TUBO PIPE	SERIE SERIES	ROSCA THREAD	Referencia Part n°	€
6	L	M10X1	Z LKL 6 M 10X1	*
8	L	M12X1.5	Z LKL 8 M 12X1.5	*
10	L	M14X1.5	Z LKL 10 M 14X1.5	*
12	L	M16X1.5	Z LKL 12 M 16X1.5	*
15	L	M18X1.5	Z LKL 15 M 18X1.5	*
18	L	M22X1.5	Z LKL 18 M 22X1.5	*
6	S	M12X1.5	Z LKS 6 M 12X1.5	*
8	S	M14X1.5	Z LKS 8 M 14X1.5	*
10	S	M16X1.5	Z LKS 10 M 16X1.5	*
12	S	M18X1.5	Z LKS 12 M 18X1.5	*
14	S	M20X1.5	Z LKS 14 M 20X1.5	*
16	S	M22X1.5	Z LKS 16 M 22X1.5	*

DIN 2353 PIPE FITTINGS

Racores DIN 2353
Verschraubungen Din 2353
Raccords à bague DIN 2353

Male stud branch TEE BSPT

Racor en T rosca cónica BSPT

T-Einschraubverschr. BSPT kon. (TR)

Raccord TÉ mâle gaz conique au centre



TUBO PIPE	SERIE SERIES	ROSCA THREAD	Referencia Part n°	€
6	L	1/8" BSPT	Z FKL 6 R 1/8	41,12
8	L	1/4" BSPT	Z FKL 8 R 1/4	37,59
10	L	1/4" BSPT	Z FKL 10 R 1/4	48,14
12	L	3/8" BSPT	Z FKL 12 R 3/8	54,31
15	L	1/2" BSPT	Z FKL 15 R 1/2	81,09
18	L	1/2" BSPT	Z FKL 18 R 1/2	102,66
6	S	1/4" BSPT	Z FKS 6 R 1/4	48,22
8	S	1/4" BSPT	Z FKS 8 R 1/4	59,44
10	S	3/8" BSPT	Z FKS 10 R 3/8	60,79
12	S	3/8" BSPT	Z FKS 12 R 3/8	71,58
14	S	1/2" BSPT	Z FKS 14 R 1/2	94,56
16	S	1/2" BSPT	Z FKS 16 1/2	110,76

Male stud branch TEE Metrical

Racor en T rosca cónica Métrica

T-Einschraubverschr. metr. kon. (TM)

Raccord TÉ mâle Métrique au centre



TUBO PIPE	SERIE SERIES	ROSCA THREAD	Referencia Part n°	€
6	L	M10X1	Z FKL 6 M 10X1	*
8	L	M12X1.5	Z FKL 8 M 12X1.5	*
10	L	M14X1.5	Z FKL 10 M 14X1.5	*
12	L	M16X1.5	Z FKL 12 M 16X1.5	*
15	L	M18X1.5	Z FKL 15 M 18X1.5	*
6	S	M12X1.5	Z FKS 6 M 12X1.5	*
8	S	M14X1.5	Z FKS 8 M 14X1.5	*
10	S	M16X1.5	Z FKS 10 M 16X1.5	*
12	S	M18X1.5	Z FKS 12 M 18X1.5	*
14	S	M20X1.5	Z FKS 14 M 20X1.5	*
16	S	M22X1.5	Z FKS 16 M 22X1.5	*

Male stud branch TEE NPT

Racor en T rosca cónica NPT

T-Einschraubverschr. NPT (T-NPT)

Raccord TÉ mâle NPT au centre



TUBO PIPE	SERIE SERIES	ROSCA THREAD	Referencia Part n°	€
6	L	1/8" NPT	Z FKL 6 R 1/8 NPT	47,28
8	L	1/4" NPT	Z FKL 8 R 1/4 NPT	43,54
10	L	1/4" NPT	Z FKL 10 R 1/4 NPT	58,93
12	L	3/8" NPT	Z FKL 12 R 3/8 NPT	66,18
18	L	1/2" NPT	Z FKL 18 R 1/2 NPT	129,68
22	L	3/4" NPT	Z FKL 22 R 3/4 NPT	164,79
28	L	1" NPT	Z FKL 28 R 1 NPT	200,43
35	L	1" 1/4 NPT	Z FKL 35 R 1 1/4 NPT	383,54
42	L	1" 1/2 NPT	Z FKL 42 R 1 1/2 NPT	395,92
6	S	1/4" NPT	Z FKS 6 R 1/4 NPT	52,01
10	S	3/8" NPT	Z FKS 10 R 3/8 NPT	56,91
12	S	3/8" NPT	Z FKS 12 R 3/8 NPT	74,29
14	S	1/2" NPT	Z FKS 14 R 1/2 NPT	74,63
16	S	1/2" NPT	Z FKS 16 R 1/2 NPT	126,97
20	S	3/4" NPT	Z FKS 20 R 3/4 NPT	148,47
25	S	1" NPT	Z FKS 25 R 1 NPT	215,28
30	S	1" 1/4 NPT	Z FKS 30 R 1 1/4 NPT	346,42
38	S	1" 1/2 NPT	Z FKS 38 R 1 1/2 NPT	532,01

DIN 2353 PIPE FITTINGS

Racores DIN 2353
Verschraubungen Din 2353
Raccords à bague DIN 2353

Standpipe reducer swivel female (light series)

Racor de reducción con TL Métrica (serie ligera)

Metr. Reduzierschraubung (Leichte Baureihe)

Raccord union simple femelle tournante Métrique (série légère)



TUBO PIPE	PIPE	SERIE SERIES	Referencia Part n°	€	Referencia Part n°	€
8	6	L	Z KORL 8-6 TLM	28,46	Z STA KORL 8-6 TLM	24,12
10	6	L	Z KORL 10-6 TLM	26,39	Z STA KORL 10-6 TLM	22,05
12	6	L	Z KORL 12-6 TLM	36,52	Z STA KORL 12-6 TLM	32,18
12	8	L	Z KORL 12-8 TLM	27,42	Z STA KORL 12-8 TLM	22,53
12	10	L	Z KORL 12-10 TLM	28,46	Z STA KORL 12-10 TLM	22,56
15	6	L	Z KORL 15-6 TLM	41,49	Z STA KORL 15-6 TLM	37,15
15	8	L	Z KORL 15-8 TLM	34,15	Z STA KORL 15-8 TLM	29,24
15	10	L	Z KORL 15-10 TLM	42,54	Z STA KORL 15-10 TLM	36,64
15	12	L	Z KORL 15-12 TLM	28,47	Z STA KORL 15-12 TLM	22,87
18	8	L	Z KORL 18-8 TLM	47,13	Z STA KORL 18-8 TLM	42,23
18	10	L	Z KORL 18-10 TLM	40,98	Z STA KORL 18-10 TLM	36,75
18	12	L	Z KORL 18-12 TLM	36,07	Z STA KORL 18-12 TLM	30,85
18	15	L	Z KORL 18-15 TLM	40,36	Z STA KORL 18-15 TLM	39,95
22	10	L	Z KORL 22-10 TLM	41,29	Z STA KORL 22-10 TLM	35,39
22	12	L	Z KORL 22-12 TLM	40,89	Z STA KORL 22-12 TLM	34,30
22	15	L	Z KORL 22-15 TLM	47,60	Z STA KORL 22-15 TLM	39,23
22	18	L	Z KORL 22-18 TLM	49,13	Z STA KORL 22-18 TLM	48,11
28	10	L	Z KORL 28-10 TLM	73,29	Z STA KORL 28-10 TLM	67,39
28	12	L	Z KORL 28-12 TLM	57,27	Z STA KORL 28-12 TLM	50,66
28	15	L	Z KORL 28-15 TLM	83,62	Z STA KORL 28-15 TLM	75,09
28	18	L	Z KORL 28-18 TLM	59,91	Z STA KORL 28-18 TLM	48,18
28	22	L	Z KORL 28-22 TLM	61,10	Z STA KORL 28-22 TLM	58,44
35	12	L	Z KORL 35-12 TLM	107,92	Z STA KORL 35-12 TLM	101,31
35	22	L	Z KORL 35-22 TLM	119,67	Z STA KORL 35-22 TLM	104,36
35	28	L	Z KORL 35-28 TLM	108,29	Z STA KORL 35-28 TLM	79,45
42	22	L	Z KORL 42-22 TLM	148,46	Z STA KORL 42-22 TLM	133,14
42	28	L	Z KORL 42-28 TLM	149,09	Z STA KORL 42-28 TLM	120,25
42	35	L	Z KORL 42-35 TLM	160,61	Z STA KORL 42-35 TLM	113,46

Standpipe reducer swivel female (heavy series)

Racor de reducción con TL Métrica (serie pesada)

Metr. Reduzierschraubung (Schwere Baureihe)

Raccord union simple femelle tournante Métrique (série lourde)



TUBO PIPE	PIPE	SERIE SERIES	Referencia Part n°	€	Referencia Part n°	€
8	6	S	Z KORS 8-6 TLM	35,66	Z STA KORS 8-6 TLM	30,59
10	6	S	Z KORS 10-6 TLM	38,48	Z STA KORS 10-6 TLM	33,41
10	8	S	Z KORS 10-8 TLM	39,85	Z STA KORS 10-8 TLM	34,35
12	6	S	Z KORS 12-6 TLM	40,39	Z STA KORS 12-6 TLM	35,32
12	8	S	Z KORS 12-8 TLM	40,39	Z STA KORS 12-8 TLM	34,89
12	10	S	Z KORS 12-10 TLM	44,58	Z STA KORS 12-10 TLM	37,67
14	10	S	Z KORS 14-10 TLM	45,76	Z STA KORS 14-10 TLM	38,85
14	12	S	Z KORS 14-12 TLM	46,75	Z STA KORS 14-12 TLM	39,29
16	6	S	Z KORS 16-6 TLM	51,50	Z STA KORS 16-6 TLM	46,43
16	8	S	Z KORS 16-8 TLM	48,50	Z STA KORS 16-8 TLM	43,00
16	10	S	Z KORS 16-10 TLM	47,39	Z STA KORS 16-10 TLM	40,48
16	12	S	Z KORS 16-12 TLM	38,68	Z STA KORS 16-12 TLM	35,95
20	8	S	Z KORS 20-8 TLM	63,36	Z STA KORS 20-8 TLM	57,86
20	10	S	Z KORS 20-10 TLM	61,27	Z STA KORS 20-10 TLM	54,36
20	12	S	Z KORS 20-12 TLM	58,23	Z STA KORS 20-12 TLM	55,73
20	14	S	Z KORS 20-14 TLM	65,09	Z STA KORS 20-14 TLM	54,09
20	16	S	Z KORS 20-16 TLM	53,71	Z STA KORS 20-16 TLM	52,59
25	12	S	Z KORS 25-12 TLM	81,44	Z STA KORS 25-12 TLM	73,99
25	16	S	Z KORS 25-16 TLM	88,48	Z STA KORS 25-16 TLM	76,37
25	20	S	Z KORS 25-20 TLM	95,43	Z STA KORS 25-20 TLM	77,21
30	16	S	Z KORS 30-16 TLM	140,34	Z STA KORS 30-16 TLM	128,23
30	20	S	Z KORS 30-20 TLM	141,70	Z STA KORS 30-20 TLM	119,59
30	25	S	Z KORS 30-25 TLM	149,81	Z STA KORS 30-25 TLM	113,68
38	20	S	Z KORS 38-20 TLM	173,96	Z STA KORS 38-20 TLM	156,93
38	25	S	Z KORS 38-25 TLM	195,19	Z STA KORS 38-25 TLM	159,06
38	30	S	Z KORS 38-30 TLM	205,18	Z STA KORS 38-30 TLM	154,68

DIN 2353 PIPE FITTINGS

Racores DIN 2353
Verschraubungen Din 2353
Raccords à bague DIN 2353

Male-female reducing adaptor BSP cylindrical with flat seal

Reducción con rosca M-HF BSP con junta plana

Reduzierstück m - w fest BSP zyl. mit
Flachdichtung

Raccord réduction mâle gaz-fem gaz avec joint plat



ROSCA (H) THREAD (F)	ROSCA (M) THREAD (M)	Referencia Part n°	€
1/4" BSP	1/8" BSP	Z RI-R 1/8 R 1/4WD	14,75
1/8" BSP	1/4" BSP	Z RI-R 1/4 R 1/8WD	14,96
3/8" BSP	1/4" BSP	Z RI-R 1/4 R 3/8WD	18,90
1/2" BSP	1/4" BSP	Z RI-R 1/4 R 1/2WD	21,74
1/8" BSP	3/8" BSP	Z RI-R 3/8 R 1/8WD	19,99
1/4" BSP	3/8" BSP	Z RI-R 3/8 R 1/4WD	17,42
1/2" BSP	3/8" BSP	Z RI-R 3/8 R 1/2WD	21,96
3/4" BSP	3/8" BSP	Z RI-R 3/8 R 3/4WD	30,91
1/8" BSP	1/2" BSP	Z RI-R 1/2 R 1/8WD	25,79
1/4" BSP	1/2" BSP	Z RI-R 1/2 R 1/4WD	18,90
3/8" BSP	1/2" BSP	Z RI-R 1/2 R 3/8WD	21,62
3/4" BSP	1/2" BSP	Z RI-R 1/2 R 3/4WD	31,21
3/8" BSP	3/4" BSP	Z RI-R 3/4 R 3/8WD	30,46
1/2" BSP	3/4" BSP	Z RI-R 3/4 R 1/2WD	32,33
1" BSP	3/4" BSP	Z RI-R 3/4 R 1WD	54,58
1/4" BSP	1" BSP	Z RI-R 1 R 1/4WD	39,30
3/8" BSP	1" BSP	Z RI-R 1 R 3/8WD	39,45
1/2" BSP	1" BSP	Z RI-R 1 R 1/2WD	37,23
3/4" BSP	1" BSP	Z RI-R 1 R 3/4WD	52,37
1"1/4 BSP	1" BSP	Z RI-R 1 R 1 1/4WD	125,47
1/2" BSP	1"1/4 BSP	Z RI-R 1 1/4 R 1/2WD	67,00
3/4" BSP	1"1/4 BSP	Z RI-R 1 1/4 R 3/4WD	71,66
1" BSP	1"1/4 BSP	Z RI-R 1 1/4 R 1WD	96,17
1"1/2 BSP	1"1/4 BSP	Z RI-R 1 1/4 R 1 1/2WD	125,25
1/2" BSP	1"1/2 BSP	Z RI-R 1 1/2 R 1/2WD	93,21
3/4" BSP	1"1/2 BSP	Z RI-R 1 1/2 R 3/4WD	89,15
1" BSP	1"1/2 BSP	Z RI-R 1 1/2 R 1WD	85,11
1"1/4 BSP	1"1/2 BSP	Z RI-R 1 1/2 R 1 1/4WD	130,89
2" BSP	1"1/2 BSP	Z RI-R 1 1/2 R 2WD	144,47
1"1/2 BSP	2" BSP	Z RI-R 2 R 1 1/2WD	176,18

DIN 2353 PIPE FITTINGS

Racores DIN 2353
Verschraubungen Din 2353
Raccords à bague DIN 2353

Adjustable stud elbow with nut and ring

Racor en codo regulable con tuerca y anillo

Einstellbarere metr. W-Verschraubung

Raccord coude orientable tube lisse équipé



TUBO PIPE	SERIE SERIES	Referencia Part n°	€	Referencia STA Part N° STA	€
6	L	Z EEL 6 CTA	26,95	Z STA EEL 6 CTA	24,75
8	L	Z EEL 8 CTA	27,41	Z STA EEL 8 CTA	23,10
12	L	Z EEL 12 CTA	33,61	Z STA EEL 12 CTA	29,69
15	L	Z EEL 15 CTA	49,49	Z STA EEL 15 CTA	43,64
22	L	Z EEL 22 CTA	92,03	Z STA EEL 22 CTA	84,46
28	L	Z EEL 28 CTA	139,36	Z STA EEL 28 CTA	155,34
35	L	Z EEL 35 CTA	179,35	Z STA EEL 35 CTA	160,43
6	S	Z EES 6 CTA	25,47	Z STA EES 6 CTA	21,20
16	S	Z EES 16 CTA	58,57	Z STA EES 16 CTA	53,57

Until end of stock / Hasta fin de existencias / Bis zum Ende des Lagerbestandes / Jusqu'à la fin du stock

Adjustable stud elbow with o'ring

Racor en codo regulable TL Métrica

Einstellbarere metr. W-Verschraubung mit O-Ring

Raccord coude orientable Métrique avec o'ring



TUBO PIPE	SERIE SERIES	Referencia Part n°	€	Referencia STA Part N° STA	€
6	L	Z EEL 6 TLM	26,41	Z STA EEL 6 TLM	24,62
8	L	Z EEL 8 TLM	26,87	Z STA EEL 8 TLM	26,61
10	L	Z EEL 10 TLM	33,16	Z STA EEL 10 TLM	27,27
12	L	Z EEL 12 TLM	38,05	Z STA EEL 12 TLM	34,85
15	L	Z EEL 15 TLM	49,05	Z STA EEL 15 TLM	46,61
18	L	Z EEL 18 TLM	68,79	Z STA EEL 18 TLM	65,74
22	L	Z EEL 22 TLM	93,80	Z STA EEL 22 TLM	84,25
28	L	Z EEL 28 TLM	136,57	Z STA EEL 28 TLM	128,39
35	L	Z EEL 35 TLM	192,78	Z STA EEL 35 TLM	171,03
42	L	Z EEL 42 TLM	330,84	Z STA EEL 42 TLM	296,53
6	S	Z EES 6 TLM	36,60	Z STA EES 6 TLM	34,17
8	S	Z EES 8 TLM	39,14	Z STA EES 8 TLM	33,70
10	S	Z EES 10 TLM	40,62	Z STA EES 10 TLM	39,05
12	S	Z EES 12 TLM	45,51	Z STA EES 12 TLM	43,68
14	S	Z EES 14 TLM	55,01	Z STA EES 14 TLM	50,56
16	S	Z EES 16 TLM	64,97	Z STA EES 16 TLM	63,58
20	S	Z EES 20 TLM	100,61	Z STA EES 20 TLM	93,11
25	S	Z EES 25 TLM	165,41	Z STA EES 25 TLM	145,45
30	S	Z EES 30 TLM	206,01	Z STA EES 30 TLM	197,09
38	S	Z EES 38 TLM	308,52	Z STA EES 38 TLM	287,08

Adjustable stud branch TEE with o'ring

Racor en T regulable TL Métrica

Einstellbare T-Verschraubung T-Form

Raccord TÉ orientable Métrique avec o'ring



TUBO PIPE	SERIE SERIES	Referencia Part n°	€	Referencia STA Part N° STA	€
6	L	Z TEL 6 TLM	33,65	Z STA TEL 6 TLM	28,85
8	L	Z TEL 8 TLM	37,38	Z STA TEL 8 TLM	31,76
10	L	Z TEL 10 TLM	41,25	Z STA TEL 10 TLM	34,64
12	L	Z TEL 12 TLM	46,60	Z STA TEL 12 TLM	40,50
15	L	Z TEL 15 TLM	80,03	Z STA TEL 15 TLM	63,06
18	L	Z TEL 18 TLM	122,12	Z STA TEL 18 TLM	98,74
22	L	Z TEL 22 TLM	142,18	Z STA TEL 22 TLM	127,77
28	L	Z TEL 28 TLM	214,60	Z STA TEL 28 TLM	183,56
35	L	Z TEL 35 TLM	386,51	Z STA TEL 35 TLM	323,56
42	L	Z TEL 42 TLM	517,22	Z STA TEL 42 TLM	401,33
6	S	Z TES 6 TLM	41,26	Z STA TES 6 TLM	32,93
8	S	Z TES 8 TLM	45,74	Z STA TES 8 TLM	38,07
10	S	Z TES 10 TLM	52,45	Z STA TES 10 TLM	44,13
12	S	Z TES 12 TLM	61,96	Z STA TES 12 TLM	53,90
14	S	Z TES 14 TLM	100,51	Z STA TES 14 TLM	90,12
16	S	Z TES 16 TLM	106,81	Z STA TES 16 TLM	101,11
20	S	Z TES 20 TLM	139,87	Z STA TES 20 TLM	127,91
25	S	Z TES 25 TLM	215,69	Z STA TES 25 TLM	180,14
30	S	Z TES 30 TLM	309,62	Z STA TES 30 TLM	262,87
38	S	Z TES 38 TLM	529,51	Z STA TES 38 TLM	393,20

Adjustable stud barrel TEE with o'ring

Racor en L regulable TL Métrica

Einstellbare T-Verschraubung L-Form

Raccord L orientable renversé Métrique avec o'ring



TUBO PIPE	SERIE SERIES	ROSCA THREAD	Referencia Part n°	€	Referencia STA Part N° STA	€
6	L	M12X1.5	Z LEL 6 TLM	33,10	Z STA LEL 6 TLM	27,52
8	L	M14X1.5	Z LEL 8 TLM	44,00	Z STA LEL 8 TLM	35,62
10	L	M16X1.5	Z LEL 10 TLM	47,77	Z STA LEL 10 TLM	40,57
12	L	M18X1.5	Z LEL 12 TLM	57,04	Z STA LEL 12 TLM	50,78
15	L	M22X1.5	Z LEL 15 TLM	82,63	Z STA LEL 15 TLM	70,91
18	L	M26X1.5	Z LEL 18 TLM	109,37	Z STA LEL 18 TLM	91,76
22	L	M30X2	Z LEL 22 TLM	150,04	Z STA LEL 22 TLM	135,20
28	L	M36X2	Z LEL 28 TLM	216,96	Z STA LEL 28 TLM	185,07
35	L	M45X2	Z LEL 35 TLM	395,65	Z STA LEL 35 TLM	303,14
42	L	M52X2	Z LEL 42 TLM	506,03	Z STA LEL 42 TLM	432,81
6	S	M14X1.5	Z LES 6 TLM	33,92	Z STA LES 6 TLM	26,08
8	S	M16X1.5	Z LES 8 TLM	44,20	Z STA LES 8 TLM	35,26
10	S	M18X1.5	Z LES 10 TLM	58,64	Z STA LES 10 TLM	50,13
12	S	M20X1.5	Z LES 12 TLM	58,45	Z STA LES 12 TLM	57,48
14	S	M22X1.5	Z LES 14 TLM	89,13	Z STA LES 14 TLM	74,21
16	S	M24X1.5	Z LES 16 TLM	101,45	Z STA LES 16 TLM	90,01
20	S	M30X2	Z LES 20 TLM	147,27	Z STA LES 20 TLM	122,49
25	S	M36X2	Z LES 25 TLM	228,22	Z STA LES 25 TLM	198,13
30	S	M42X2	Z LES 30 TLM	340,69	Z STA LES 30 TLM	288,11
38	S	M52X2	Z LES 38 TLM	564,50	Z STA LES 38 TLM	428,19

DIN 2353 PIPE FITTINGS

Racores DIN 2353
Verschraubungen Din 2353
Raccords à bague DIN 2353

Straight connection with o'ring

Racor unión TL Métrica

Gerader Zwischenstutzen mit O-Ring

Raccord union tournante Métrique égale



TUBO PIPE	SERIE SERIES	Referencia Part n°	€
6	L	Z ATL 6	28,28
8	L	Z ATL 8	29,65
10	L	Z ATL 10	28,29
12	L	Z ATL 12	34,41
15	L	Z ATL 15	47,78
18	L	Z ATL 18	62,19
22	L	Z ATL 22	66,56
28	L	Z ATL 28	102,30
35	L	Z ATL 35	159,94
42	L	Z ATL 42	213,70
6	S	Z ATS 6	39,24
8	S	Z ATS 8	34,26
10	S	Z ATS 10	33,57
12	S	Z ATS 12	43,87
14	S	Z ATS 14	54,55
16	S	Z ATS 16	55,85
20	S	Z ATS 20	73,08
25	S	Z ATS 25	101,24
30	S	Z ATS 30	168,72
38	S	Z ATS 38	226,80

Straight stud standpipe adaptor with captive seal BSP cylindrical-metric swivel fem.

Racor recto macho BSP con junta plana - TLM

Gerader Einschraubstutzen BSP ZYL. M/Dichtkegel und O-Ring

Raccord adapt.tube lisse-mâle gaz BSP avec joint plat-fem.tourn.métrique



TUBO PIPE	SERIE SERIES	ROSCA THREAD	Referencia Part n°	€
6	L	1/8"BSP	Z RAL 6 R 1/8TLMWD	30,39
8	L	1/4"BSP	Z RAL 8 R 1/4TLMWD	29,79
10	L	1/4"BSP	Z RAL 10 R 1/4TLMWD	27,36
12	L	1/4"BSP	Z RAL 12 R 1/4TLMWD	28,06
12	L	3/8"BSP	Z RAL 12 R 3/8TLMWD	29,07
12	L	1/2"BSP	Z RAL 12 R 1/2TLMWD	31,35
15	L	1/2"BSP	Z RAL 15 R 1/2TLMWD	38,05
18	L	1/2"BSP	Z RAL 18 R 1/2TLMWD	50,95
22	L	3/4"BSP	Z RAL 22 R 3/4TLMWD	54,85
28	L	1"BSP	Z RAL 28 R 1TLMWD	94,35
35	L	1 1/4 BSP	Z RAL 35 R 1 1/4TLMWD	131,30
42	L	1 1/2 BSP	Z RAL 42 R 1 1/2TLMWD	179,57
6	S	1/4"BSP	Z RAS 6 R 1/4TLMWD	33,09
8	S	1/4"BSP	Z RAS 8 R 1/4TLMWD	27,36
10	S	3/8"BSP	Z RAS 10 R 3/8TLMWD	30,56
12	S	3/8"BSP	Z RAS 12 R 3/8TLMWD	30,64
12	S	1/2"BSP	NEW Z RAS 12 R 1/2TLMWD	35,24
14	S	1/2"BSP	Z RAS 14 R 1/2TLMWD	40,48
16	S	1/2"BSP	Z RAS 16 R 1/2TLMWD	53,64
20	S	3/4"BSP	Z RAS 20 R 3/4TLMWD	56,91
25	S	1"BSP	Z RAS 25 R 1TLMWD	100,14
30	S	1 1/4 BSP	Z RAS 30 R 1 1/4TLMWD	129,70
38	S	1 1/2 BSP	Z RAS 38 R 1 1/2TLMWD	174,18

Straight stud standpipe adaptor NPT- metric swivel fem.

Racor recto macho NPT - TL Metrica

Gerader Einschraubstutzen NPT M/Dichtkegel

Raccord adapteur tube lisse - mâle NPT- fem. tourn. métrique



TUBO PIPE	SERIE SERIES	ROSCA THREAD	Referencia Part n°	€
6	L	1/8"NPT	Z RAL 6 R 1/8 NPTTLM	29,00
8	L	1/4"NPT	Z RAL 8 R 1/4 NPTTLM	29,89
10	L	1/4"NPT	Z RAL 10 R 1/4 NPTTLM	30,80
12	L	3/8" NPT	Z RAL 12 R 3/8 NPTTLM	41,05
15	L	1/2" NPT	Z RAL 15 R 1/2 NPTTLM	31,28
18	L	1/2"NPT	Z RAL 18 R 1/2 NPTTLM	64,98
22	L	3/4"NPT	Z RAL 22 R 3/4 NPTTLM	69,76
28	L	1"NPT	Z RAL 28 R 1 NPTTLM	104,36
35	L	1 1/4 NPT	Z RAL 35 R 1 1/4 NPTTLM	136,32
42	L	1 1/2 NPT	Z RAL 42 R 1 1/2 NPTTLM	186,84
6	S	1/4"NPT	Z RAS 6 R 1/4 NPTTLM	27,43
8	S	1/4"NPT	Z RAS 8 R 1/4 NPTTLM	28,81
10	S	3/8"NPT	Z RAS 10 R 3/8 NPTTLM	33,09
12	S	1/4" NPT	Z RAS 12 R 1/4 NPTTLM	25,71
14	S	1/2"NPT	Z RAS 14 R 1/2 NPTTLM	43,37
16	S	1/2"NPT	Z RAS 16 R 1/2 NPTTLM	65,10
20	S	3/4"NPT	Z RAS 20 R 3/4 NPTTLM	91,99
25	S	3/4"NPT	Z RAS 25 R 3/4 NPTTLM	110,83
25	S	1"NPT	Z RAS 25 R 1 NPTTLM	97,34
30	S	1"NPT	Z RAS 30 R 1 NPTTLM	120,96
30	S	1 1/4 NPT	Z RAS 30 R 1 1/4 NPTTLM	152,01
38	S	1 1/2 NPT	Z RAS 38 R 1 1/2 NPTTLM	236,79

Straight stud standpipe adaptor Metric with captive seal-metric swivel fem.

Racor recto macho Métrico con junta plana - tubo TLM

Gerader Einschraubstutzen metr. ZYL. M/ Dichtkegel und O-Ring

Raccord adapt.tube lisse-mâle Métrique avec joint plat-fem.tourn.métrique



TUBO PIPE	SERIE SERIES	ROSCA THREAD	Referencia Part n°	€
6	L	M10X1	Z RAL 6M10X1TLMWD	32,85
8	L	M12X1.5	Z RAL 8M12X1.5TLMWD	29,05
10	L	M14X1.5	Z RAL 10M14X1.5TLMWD	36,88
12	L	M16X1.5	Z RAL 12M16X1.5TLMWD	35,55
15	L	M18X1.5	Z RAL 15M18X1.5TLMWD	44,58
18	L	M22X1.5	Z RAL 18M22X1.5TLMWD	57,27
22	L	M26X1.5	Z RAL 22M26X1.5TLMWD	66,06
28	L	M33X2	Z RAL 28M33X2TLMWD	105,23
35	L	M42X2	Z RAL 35M42X2TLMWD	162,28
42	L	M48X2	Z RAL 42M48X2TLMWD	183,71
6	S	M12X1.5	Z RAS 6M12X1.5TLMWD	33,09
8	S	M14X1.5	Z RAS 8M14X1.5TLMWD	32,69
10	S	M16X1.5	Z RAS 10M16X1.5TLMWD	34,44
12	S	M18X1.5	Z RAS 12M18X1.5TLMWD	37,75
14	S	M20X1.5	Z RAS 14M20X1.5TLMWD	51,67
16	S	M22X1.5	Z RAS 16M22X1.5TLMWD	56,59
20	S	M27X2	Z RAS 20M27X2TLMWD	76,85
25	S	M33X2	Z RAS 25M33X2TLMWD	113,64
30	S	M42X2	Z RAS 30M42X2TLMWD	156,57
38	S	M48X2	Z RAS 38M48X2TLMWD	202,78

DIN 2353 PIPE FITTINGS

Racores DIN 2353
Verschraubungen Din 2353
Raccords à bague DIN 2353

Weldable straight coupling

Racor recto para soldar

Gerade Anschweiß-Versch. (GAV)

Raccord mamelon hexagonal Métrique à souder



TUBO PIPE	SERIE SERIES	Referencia Part n°	€	Referencia STA Part N° STA	€
6	L	Z ASL 6	11,45	Z STA ASL 6	7,56
8	L	Z ASL 8	13,12	Z STA ASL 8	9,02
10	L	Z ASL 10	16,57	Z STA ASL 10	10,67
12	L	Z ASL 12	15,32	Z STA ASL 12	11,26
15	L	Z ASL 15	25,09	Z STA ASL 15	16,74
18	L	Z ASL 18	28,77	Z STA ASL 18	20,52
22	L	Z ASL 22	40,90	Z STA ASL 22	26,65
28	L	Z ASL 28	61,85	Z STA ASL 28	37,90
35	L	Z ASL 35	100,37	Z STA ASL 35	53,22
42	L	Z ASL 42	131,04	Z STA ASL 42	75,47
6	S	Z ASS 6	27,30	Z STA ASS 6	22,23
8	S	Z ASS 8	31,41	Z STA ASS 8	25,91
10	S	Z ASS 10	37,17	Z STA ASS 10	30,27
12	S	Z ASS 12	29,16	Z STA ASS 12	21,70
14	S	Z ASS 14	57,89	Z STA ASS 14	46,90
16	S	Z ASS 16	29,02	Z STA ASS 16	21,75
20	S	Z ASS 20	47,72	Z STA ASS 20	30,69
25	S	Z ASS 25	69,27	Z STA ASS 25	34,77
30	S	Z ASS 30	91,03	Z STA ASS 30	49,47
38	S	Z ASS 38	166,28	Z STA ASS 38	106,72

Welding nipple with o-ring

Boquilla para soldar

Schweißkegel (SK)

Raccord collet cône métrique à souder



TUBO PIPE	SERIE SERIES	Referencia Part n°	€
15x2.5	L	Z ORIL 15	9,71
18x2.5	L	Z ORIL 18	14,28
22x2.5	L	Z ORIL 22	16,73
28x3	L	Z ORIL 28	23,23
35x4	L	Z ORIL 35	33,50
42x3	L	Z ORIL 42	58,88
6x2	L/S	Z ORIS 6	11,48
8x2	L/S	Z ORIS 8	9,06
10x2	L/S	Z ORIS 10	9,05
12x2	L/S	Z ORIS 12	9,24
14x3	S	Z ORIS 14	17,96
16x3	S	Z ORIS 16	13,20
20x3	S	Z ORIS 20	16,14
25x3.5	S	Z ORIS 25	23,34
30x5	S	Z ORIS 30	29,06
38x5	S	Z ORIS 38	41,49

Weldable bulkhead coupling

Racor pasatabique para soldar

Schweiß-Schottverschraubung (ESV)

Raccord union double passe cloison
Métrique à souder



TUBO PIPE	SERIE SERIES	Referencia Part n°	€	Referencia STA Part N° STA	€
6	L	Z ESVL 6	23,95	Z STA ESVL 6	15,35
8	L	Z ESVL 8	27,49	Z STA ESVL 8	17,76
10	L	Z ESVL 10	30,41	Z STA ESVL 10	18,70
12	L	Z ESVL 12	33,92	Z STA ESVL 12	20,77
15	L	Z ESVL 15	45,62	Z STA ESVL 15	28,65
18	L	Z ESVL 18	65,60	Z STA ESVL 18	42,22
22	L	Z ESVL 22	88,17	Z STA ESVL 22	57,62
28	L	Z ESVL 28	109,96	Z STA ESVL 28	52,36
35	L	Z ESVL 35	162,10	Z STA ESVL 35	67,89
42	L	Z ESVL 42	208,22	Z STA ESVL 42	105,40
6	S	Z ESVS 6	32,56	Z STA ESVS 6	22,49
8	S	Z ESVS 8	36,35	Z STA ESVS 8	25,43
10	S	Z ESVS 10	52,82	Z STA ESVS 10	39,09
12	S	Z ESVS 12	49,97	Z STA ESVS 12	35,14
14	S	Z ESVS 14	64,16	Z STA ESVS 14	42,25
16	S	Z ESVS 16	70,16	Z STA ESVS 16	48,18
20	S	Z ESVS 20	105,28	Z STA ESVS 20	71,30
25	S	Z ESVS 25	135,54	Z STA ESVS 25	63,36
30	S	Z ESVS 30	169,37	Z STA ESVS 30	73,74
38	S	Z ESVS 38	253,94	Z STA ESVS 38	117,63

DIN 2353 PIPE FITTINGS

Racores DIN 2353
Verschraubungen Din 2353
Raccords à bague DIN 2353

Straight bulkhead coupling

Racor recto pasatabique con tuerca

Gerade Schottverschraubung - GSV

Raccord droit union double passe cloison
avec écrou



TUBO PIPE	SERIE SERIES	Referencia Part n°	€	Referencia STA Part N° STA	€
6	L	Z SVL 6	20,55	Z STA SVL 6	13,42
8	L	Z SVL 8	23,51	Z STA SVL 8	16,89
10	L	Z SVL 10	30,52	Z STA SVL 10	25,09
12	L	Z SVL 12	30,64	Z STA SVL 12	29,05
15	L	Z SVL 15	44,68	Z STA SVL 15	37,54
18	L	Z SVL 18	71,05	Z STA SVL 18	52,55
22	L	Z SVL 22	87,17	Z STA SVL 22	70,41
28	L	Z SVL 28	121,73	Z STA SVL 28	80,24
35	L	Z SVL 35	193,08	Z STA SVL 35	124,69
42	L	Z SVL 42	268,80	Z STA SVL 42	152,90
6	S	Z SVS 6	33,34	Z STA SVS 6	25,32
8	S	Z SVS 8	34,98	Z STA SVS 8	26,65
10	S	Z SVS 10	40,15	Z STA SVS 10	31,13
12	S	Z SVS 12	45,56	Z STA SVS 12	37,58
14	S	Z SVS 14	60,52	Z STA SVS 14	49,04
16	S	Z SVS 16	66,26	Z STA SVS 16	47,82
20	S	Z SVS 20	106,63	Z STA SVS 20	86,46
25	S	Z SVS 25	150,18	Z STA SVS 25	107,80
30	S	Z SVS 30	214,10	Z STA SVS 30	118,48
38	S	Z SVS 38	336,36	Z STA SVS 38	226,31

Metric nut bulkhead

Tuerca pasatabique Métrica

Metr. Gegenmuttern für Schottverschraubungen
- GM-M

Écrou Métrique passe cloison



TUBO PIPE	ROSCA THREAD	Referencia Part n°	€
6L	M12x1.5	KZTPM12	2,74
8L / 6S	M14x1.5	KZTPM14	2,43
10L / 8S	M16x1.5	KZTPM16	3,13
12L / 10S	M18x1.5	KZTPM18	4,21
12S	M20x1.5	KZTPM20	5,06
15L / 14S	M22x1.5	KZTPM22	6,25
16S	M24x1.5	KZTPM24	7,53
18L	M26x1.5	KZTPM26	11,01
22L / 20S	M30x2	KZTPM30	14,35
28L / 25S	M36x2	KZTPM36	21,18
30S	M42x2	KZTPM42	27,60
35L	M45x2	KZTPM45	28,04
42L / 38S	M52x2	KZTPM52	38,50

Elbow bulkhead coupling

Racor en codo pasatabique con tuerca

W-Schottversch. - WSV

Raccord coude égal passe cloison



TUBO PIPE	SERIE SERIES	Referencia Part n°	€	Referencia STA Part N° STA	€
6	L	Z USVL 6	50,67	Z STA USVL 6	45,25
8	L	Z USVL 8	52,46	Z STA USVL 8	42,73
10	L	Z USVL 10	50,67	Z STA USVL 10	38,96
12	L	Z USVL 12	54,29	Z STA USVL 12	41,15
15	L	Z USVL 15	85,84	Z STA USVL 15	73,96
18	L	Z USVL 18	97,41	Z STA USVL 18	74,03
22	L	Z USVL 22	146,53	Z STA USVL 22	115,98
28	L	Z USVL 28	286,33	Z STA USVL 28	228,73
35	L	Z USVL 35	513,30	Z STA USVL 35	419,08
42	L	Z USVL 42	661,90	Z STA USVL 42	546,01
6	S	Z USVS 6	69,49	Z STA USVS 6	59,42
8	S	Z USVS 8	59,92	Z STA USVS 8	53,81
10	S	Z USVS 10	63,19	Z STA USVS 10	49,46
12	S	Z USVS 12	70,34	Z STA USVS 12	55,51
14	S	Z USVS 14	101,99	Z STA USVS 14	80,09
16	S	Z USVS 16	103,60	Z STA USVS 16	79,48
20	S	Z USVS 20	180,34	Z STA USVS 20	146,36
25	S	Z USVS 25	309,95	Z STA USVS 25	237,77
30	S	Z USVS 30	432,25	Z STA USVS 30	336,63

DIN 2353 PIPE FITTINGS

Racores DIN 2353
Verschraubungen Din 2353
Raccords à bague DIN 2353

Female stud coupling

Racor recto hembra rosca BSP

Gerader Aufschraubstutzen –
Innengewinde BSP = GAI- R

Raccord union simple femelle gaz



TUBO PIPE	SERIE SERIES	ROSCA THREAD	Referencia Part n°	€	Referencia STA Part N° STA	€
6	L	1/8" BSP	Z GAIL 6 R 1/8	14,69	Z STA GAIL 6 R 1/8	12,10
6	L	1/4" BSP	Z GAIL 6 R 1/4	15,49	Z STA GAIL 6 R 1/4	13,45
8	L	1/4" BSP	Z GAIL 8 R 1/4	18,48	Z STA GAIL 8 R 1/4	15,10
10	L	1/4" BSP	Z GAIL 10 R 1/4	17,49	Z STA GAIL 10 R 1/4	14,32
12	L	1/2" BSP	Z GAIL 12 R 1/2	24,89	Z STA GAIL 12 R 1/2	20,39
12	L	3/8" BSP	Z GAIL 12 R 3/8	25,00	Z STA GAIL 12 R 3/8	20,89
15	L	1/2" BSP	Z GAIL 15 R 1/2	30,71	Z STA GAIL 15 R 1/2	22,30
18	L	1/2" BSP	Z GAIL 18 R 1/2	36,78	Z STA GAIL 18 R 1/2	25,05
22	L	3/8" BSP	Z GAIL 22 R 3/4	45,33	Z STA GAIL 22 R 3/4	32,88
28	L	1" BSP	Z GAIL 28 R 1	72,90	Z STA GAIL 28 R 1	52,91
35	L	1 1/4" BSP	Z GAIL 35 R 1 1/4	151,96	Z STA GAIL 35 R 1 1/4	104,81
42	L	1 1/2" BSP	Z GAIL 42 R 1 1/2	189,12	Z STA GAIL 42 R 1 1/2	131,13
6	S	1/4" BSP	Z GAIS 6 R 1/4	20,94	Z STA GAIS 6 R 1/4	16,37
8	S	1/4" BSP	Z GAIS 8 R 1/4	21,49	Z STA GAIS 8 R 1/4	16,05
10	S	3/8" BSP	Z GAIS 10 R 3/8	24,44	Z STA GAIS 10 R 3/8	19,42
12	S	3/8" BSP	Z GAIS 12 R 3/8	29,86	Z STA GAIS 12 R 3/8	23,21
14	S	3/8" BSP	Z GAIS 14 R 3/8 *	38,83	---	*
14	S	1/2" BSP	Z GAIS 14 R 1/2	38,02	Z STA GAIS 14 R 1/2	29,24
16	S	1/2" BSP	Z GAIS 16 R 1/2	35,36	Z STA GAIS 16 R 1/2	24,43
20	S	3/4" BSP	Z GAIS 20 R 3/4	63,16	Z STA GAIS 20 R 3/4	46,12
25	S	1" BSP	Z GAIS 25 R 1	84,52	Z STA GAIS 25 R 1	48,14
30	S	1 1/4" BSP	Z GAIS 30 R 1 1/4	140,47	Z STA GAIS 30 R 1 1/4	92,62
38	S	1 1/2" BSP	Z GAIS 38 R 1 1/2	172,23	Z STA GAIS 38 R 1 1/2	113,97

*Until end of stock / Hasta fin de existencias / Bis zum Ende des Lagerbestandes / Jusqu'à la fin du stock

Gauge coupling BSP cylindrical

Racor para manómetro BSP

Manometer-Verschraubung BSP ZYL - MAV-BSP

Raccord union pour manomètre gaz



TUBO PIPE	SERIE SERIES	ROSCA THREAD	Referencia Part n°	€
6	L	1/4" BSP	Z MAVL 6 R 1/4	21,28
8	L	1/4" BSP	Z MAVL 8 R 1/4	21,28
10	L	1/4" BSP	Z MAVL 10 R 1/4	25,41
12	L	1/4" BSP	Z MAVL 12 R 1/4	25,41
6	S	1/2" BSP	Z MAVS 6 R 1/2	32,70
8	S	1/2" BSP	Z MAVS 8 R 1/2	31,74
10	S	1/2" BSP	Z MAVS 10 R 1/2	37,57
12	S	1/2" BSP	Z MAVS 12 R 1/2	32,70

Female stud coupling Metric Cylindrical

Racor recto hembra rosca Métrica

Gerader Aufschraubstutzen – metr.
Innengewinde = GAI- M

Raccord union simple femelle Métrique



TUBO PIPE	SERIE SERIES	ROSCA THREAD	Referencia Part n°	€
6	L	M10X1	Z GAIL 6 M 10X1	19,05
8	L	M12X1.5	Z GAIL 8 M 12X1.5	23,65
10	L	M14X1.5	Z GAIL 10 M 14X1.5	26,22
12	L	M16X1.5	Z GAIL 12 M 16X1.5	31,28
15	L	M18X1.5	Z GAIL 15 M 18X1.5	44,31
18	L	M22X1.5	Z GAIL 18 M 22X1.5	52,67
22	L	M26X1.5	Z GAIL 22 M 26X1.5	57,96
28	L	M33X2	Z GAIL 28 M 33X2	87,80
35	L	M42X2	Z GAIL 35 M 42X2	159,39
42	L	M48X2	Z GAIL 42 M 48X2	211,82
6	S	M12X1.5	Z GAIS 6 M 12X1.5	27,01
8	S	M14X1.5	Z GAIS 8 M 14X1.5	32,69
10	S	M16X1.5	Z GAIS 10 M 16X1.5	31,48
12	S	M18X1.5	Z GAIS 12 M 18X1.5	39,18
14	S	M20X1.5	Z GAIS 14 M 20X1.5	48,63
16	S	M22X1.5	Z GAIS 16 M 22X1.5	52,67
20	S	M27X2	Z GAIS 20 M 27X2	74,83
25	S	M33X2	Z GAIS 25 M 33X2	107,38
30	S	M42X2	Z GAIS 30 M 42X2	260,11
38	S	M48X2	Z GAIS 38 M 48X2	353,16

Seal for gauge coupling

Arandela para manómetros

Dichtkanten-Ring für Manometer-Anschlüsse - DKI

Raccord bague pour manomètres



ROSCA THREAD	Referencia Part n°	€
1/4" BSP	Z AM 6	5,95
1/2" BSP	Z AM 12	6,89

DIN 2353 PIPE FITTINGS

Racores DIN 2353
Verschraubungen Din 2353
Raccords à bague DIN 2353

Banjo coupling with captive seal and o'ring BSP cylindrical

Racor en codo orientable sin estrangulación rosca BSP

Schwenkversch. mit Dichtkegel und O-Ring BSP ZYL

Raccord équerre orientable articulée sans étranglement gaz

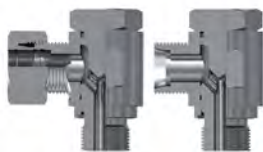

TUBO PIPE	SERIE SERIES	ROSCA THREAD	Referencia Part n°	€	Referencia STA Part N° STA	€
6	L	1/8" BSP	Z WSVL 6 R 1/8	78,96	Z STA WSVL 6 R 1/8	74,54
6	L	1/4" BSP	Z WSVL 6 R 1/4	105,37	Z STA WSVL 6 R 1/4	101,03
8	L	1/4" BSP	Z WSVL 8 R 1/4	83,00	Z STA WSVL 8 R 1/4	79,67
10	L	1/4" BSP	Z WSVL 10 R 1/4	79,05	Z STA WSVL 10 R 1/4	75,72
12	L	3/8" BSP	Z WSVL 12 R 3/8	94,94	Z STA WSVL 12 R 3/8	91,10
15	L	1/2" BSP	Z WSVL 15 R 1/2	130,58	Z STA WSVL 15 R 1/2	125,35
18	L	1/2" BSP	Z WSVL 18 R 1/2	168,04	Z STA WSVL 18 R 1/2	160,10
22	L	3/4" BSP	Z WSVL 22 R 3/4	343,11	Z STA WSVL 22 R 3/4	327,79
28	L	1" BSP	Z WSVL 28 R 1	573,43	Z STA WSVL 28 R 1	544,60
35	L	1 1/4" BSP	Z WSVL 35 R 1 1/4	748,53	Z STA WSVL 35 R 1 1/4	701,38
42	L	1 1/2" BSP	Z WSVL 42 R 1 1/2	1.035,01	Z STA WSVL 42 R 1 1/2	977,02
6	S	1/4" BSP	Z WSVS 6 R 1/4	85,04	Z STA WSVS 6 R 1/4	80,67
8	S	1/4" BSP	Z WSVS 8 R 1/4	93,13	Z STA WSVS 8 R 1/4	88,38
10	S	3/8" BSP	Z WSVS 10 R 3/8	105,28	Z STA WSVS 10 R 3/8	101,05
12	S	3/8" BSP	Z WSVS 12 R 3/8	118,44	Z STA WSVS 12 R 3/8	114,04
14	S	1/2" BSP	Z WSVS 14 R 1/2	185,06	Z STA WSVS 14 R 1/2	174,07
16	S	1/2" BSP	Z WSVS 16 R 1/2	174,01	Z STA WSVS 16 R 1/2	167,24
20	S	3/4" BSP	Z WSVS 20 R 3/4	347,66	Z STA WSVS 20 R 3/4	330,63
25	S	1" BSP	Z WSVS 25 R 1	500,48	Z STA WSVS 25 R 1	464,36
30	S	1 1/4" BSP	Z WSVS 30 R 1 1/4	893,41	Z STA WSVS 30 R 1 1/4	845,56
38	S	1 1/2" BSP	Z WSVS 38 R 1 1/2	1.248,81	Z STA WSVS 38 R 1 1/2	1.180,61

Banjo coupling with captive seal and o'ring Metric cylindrical

Racor en codo orientable sin estrangulación rosca Métrica

Schwenkversch. mit Dichtkegel und O-Ring metr. ZYL

Raccord équerre orientable articulée sans étranglement Métrique

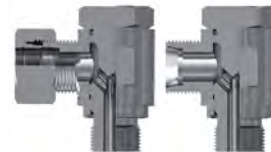

TUBO PIPE	SERIE SERIES	ROSCA THREAD	Referencia Part n°	€	Referencia STA Part N° STA	€
6	L	M10X1	Z WSVL 6 M 10X1	83,00	Z STA WSVL 6 M 10X1	80,15
8	L	M12X1.5	Z WSVL 8 M 12X1,5	87,06	Z STA WSVL 8 M 12X1,5	83,98
10	L	M14X1.5	Z WSVL 10 M 14X1,5	125,62	Z STA WSVL 10 M 14X1,5	119,73
12	L	M16X1.5	Z WSVL 12 M 16X1,5	135,08	Z STA WSVL 12 M 16X1,5	128,47
15	L	M18X1.5	Z WSVL 15 M 18X1,5	181,01	Z STA WSVL 15 M 18X1,5	172,48
18	L	M22X1.5	Z WSVL 18 M 22X1,5	221,53	Z STA WSVL 18 M 22X1,5	209,80
22	L	M26X1.5	Z WSVL 22 M 26X1,5	*	Z STA WSVL 22 M 26X1,5	*
28	L	M33X2	Z WSVL 28 M 33X2	*	Z STA WSVL 28 M 33X2	*
35	L	M42X2	Z WSVL 35 M 42X2	*	Z STA WSVL 35 M 42X2	*
42	L	M48X2	Z WSVL 42 M 48X2	*	Z STA WSVL 42 M 48X2	*
6	S	M12X1.5	Z WSVS 6 M 12X1,5	118,87	Z STA WSVS 6 M 12X1,5	113,79
8	S	M14X1.5	Z WSVS 8 M 14X1,5	126,97	Z STA WSVS 8 M 14X1,5	121,47
10	S	M16X1.5	Z WSVS 10 M 16X1,5	148,59	Z STA WSVS 10 M 16X1,5	141,69
12	S	M18X1.5	Z WSVS 12 M 18X1,5	164,79	Z STA WSVS 12 M 18X1,5	157,34
14	S	M22X1.5	Z WSVS 14 M 20X1,5	143,74	Z STA WSVS 14 M 20X1,5	132,75
16	S	M27X2	Z WSVS 16 M 22X1,5	245,85	Z STA WSVS 16 M 22X1,5	233,75
20	S	M33X2	Z WSVS 20 M 27X2	357,96	Z STA WSVS 20 M 27X2	340,93
30	S	M42X2	Z WSVS 30 M 42X2	677,04	Z STA WSVS 30 M 42X2	629,19
38	S	M48x2	Z WSVS 38 M 48X2	*	Z STA WSVS 38 M 48X2	*

DIN 2353 PIPE FITTINGS

Racores DIN 2353
Verschraubungen Din 2353
Raccords à bague DIN 2353

Blanking plug with o'ring

Tapón de cierre para tubo con junta tórica

Verschlusskegel mit O-Ring

Raccord bouchon de fermeture avec o'ring



TUBO PIPE	SERIE SERIES	Referencia Part n°	€
6	L/S	Z BUTZEN L 6	6,43
8	L/S	Z BUTZEN L 8	5,83
10	L/S	Z BUTZEN L 10	6,01
12	L/S	Z BUTZEN L 12	7,19
15	L	Z BUTZEN L 15	8,18
18	L	Z BUTZEN L 18	10,35
22	L	Z BUTZEN L 22	14,25
28	L	Z BUTZEN L 28	21,73
35	L	Z BUTZEN L 35	37,25
42	L	Z BUTZEN L 42	51,23
14	S	Z BUTZEN S 14	10,87
16	S	Z BUTZEN S 16	10,23
20	S	Z BUTZEN S 20	22,76
25	S	Z BUTZEN S 25	18,11
30	S	Z BUTZEN S 30	29,91
38	S	Z BUTZEN S 38	49,05

Green FKM o-ring

Juntas tóricas FKM verde

O-Ring FKM grün - DOZ FKM

Joint torique en FKM vert



TUBO PIPE	Referencia Part n°	€
6	JVT06	0,83
8	JVT08	0,90
10	JVT10	0,97
12	JVT12	1,02
14	JVT14	1,11
15-16	JVT15	1,09
18	JVT18	1,29
20	JVT20	1,29
22	JVT22	1,38
25	JVT25	1,43
28	JVT28	1,50
30	JVT30	1,60
35	JVT35	2,22
38	JVT38	2,34
42	JVT42	2,54

Blanking plug with captive seal BSP cylindrical

Tapón de cierre Allen rosca BSP con junta

Verschlussverschraubung Innensechskant mit Dichtung BSP

Raccord bouchon Allen gaz avec joint plat



ROSCA THREAD	Referencia Part n°	€
1/8" BSP	Z STOPFEN 1/8	6,68
1/4" BSP	Z STOPFEN 1/4	7,41
3/8" BSP	Z STOPFEN 3/8	8,57
1/2" BSP	Z STOPFEN 1/2	11,08
3/4" BSP	Z STOPFEN 3/4	15,61
1" BSP	Z STOPFEN 1	24,38
1"1/4 BSP	Z STOPFEN 1 1/4	44,50
1"1/2 BSP	Z STOPFEN 1 1/2	50,08

Green FKM captive seal

Juntas planas FKM verde

Dichtring flach FKM grün- DOZ FKM KL

Joint plat en FKM vert



ROSCA THREAD	Referencia Part n°	€
1/8" BSP - M10x1	JVBSP02	3,19
M12x1.5	JVM12	3,19
1/4" BSP - M14x1.5	JVBSP04	3,13
M16x1.5	JVM16	3,19
3/8" BSP	JVBSP06	3,19
M18x1.5	JVM18	3,33
M20x1.5	JVM20	3,33
1/2" BSP	JVBSP08	3,34
M22x1.5	JVM22	3,41
3/4" BSP - M26x1.5	JVBSP12	3,40
1" BSP - M33x2	JVBSP16	3,54
1"1/4 BSP - M42x2	JVBSP20	5,42
1"1/2 BSP - M48x2	JVBSP24	5,83
2" BSP	JVBSP32	20,15

Blanking plug with captive seal Metric cylindrical

Tapón de cierre Allen rosca Métrica con junta

Verschlussverschraubung Innensechskant mit Dichtung Metr.

Raccord bouchon Allen Métrique avec joint plat



ROSCA THREAD	Referencia Part n°	€
M10X1	Z STOPFEN M 10X1	7,46
M12X1,5	Z STOPFEN M 12X1,5	8,35
M14X1,5	Z STOPFEN M 14X1,5	8,00
M16X1,5	Z STOPFEN M 16X1,5	9,42
M18X1,5	Z STOPFEN M 18X1,5	10,67
M20X1,5	Z STOPFEN M 20X1,5	16,91
M22X1,5	Z STOPFEN M 22X1,5	19,18
M26X1,5	Z STOPFEN M 26X1,5	31,08
M27X2	Z STOPFEN M 27X2	27,83
M33X2	Z STOPFEN M 33X2	38,22
M42X2	Z STOPFEN M 42X2	45,42
M48X2	Z STOPFEN M 48X2	79,68

DIN 2353 PIPE FITTINGS

Racores DIN 2353
Verschraubungen Din 2353
Raccords à bague DIN 2353

Tool for manual pre-assembly

Vomo

Werkzeug für die manuelle Vormontage

Outil pour pre-montage



TUBO PIPE	SERIE SERIES	ROSCA THREAD	Referencia Part n°	€
6	L	12x1.5	Z VOMO L 6	*
8	L	14x1.5	Z VOMO L 8	*
10	L	16x1.5	Z VOMO L 10	*
12	L	18x1.5	Z VOMO L 12	*
15	L	22x1.5	Z VOMO L 15	*
18	L	26x1.5	Z VOMO L 18	*
22	L	30x2.0	Z VOMO L 22	*
28	L	36x2.0	Z VOMO L 28	*
35	L	45x2.0	Z VOMO L 35	*
42	L	52x2.0	Z VOMO L 42	*
6	S	14x1.5	Z VOMO S 6	*
8	S	16x1.5	Z VOMO S 8	*
10	S	18x1.5	Z VOMO S 10	*
12	S	20x1.5	Z VOMO S 12	*
14	S	22x1.5	Z VOMO S 14	*
16	S	24x1.5	Z VOMO S 16	*
20	S	30x2.0	Z VOMO S 20	*
25	S	36x2.0	Z VOMO S 25	*
30	S	42x2.0	Z VOMO S 30	*

Made of Hardened tool-steel / Material Acero Templado / Material Gehärteter Stahl / Matériel Acier Trempé

Grease

Grasa

Fett

Graisse



PESO (gr) WEIGHT (gr)	Referencia Part n°	€
145	GR ASW120	71,79

DIN 2353 PIPE FITTINGS

Racores DIN 2353
Verschraubungen Din 2353
Raccords à bague DIN 2353

Non-return valve flow from male stud end BSP cylindrical

Válvula antirretorno rosca BSP-tubo

Rückschlagventil einseitig sperrend BSP Stecker (m)-Rohr

Clapet anti-rétour unidirectionnel à gauche mâle-tube



TUBO PIPE	SERIE SERIES	ROSCA THREAD	Referencia Part n°	€
6	L	1/8" BSP	Z RHVL 6 R 1/8	*
8	L	1/4" BSP	Z RHVL 8 R 1/4	*
10	L	1/4" BSP	Z RHVL 10 R 1/4	*
12	L	3/8" BSP	Z RHVL 12 R 3/8	*
15	L	1/2" BSP	Z RHVL 15 R 1/2	*
18	L	1/2" BSP	Z RHVL 18 R 1/2	*
22	L	3/4" BSP	Z RHVL 22 R 3/4	*
28	L	1" BSP	Z RHVL 28 R 1	*
35	L	1"1/4 BSP	Z RHVL 35 R 1 1/4	*
42	L	1"1/2 BSP	Z RHVL 42 R 1 1/2	*
6	S	1/4" BSP	Z RHVS 6 R 1/4	*
8	S	1/4" BSP	Z RHVS 8 R 1/4	*
10	S	3/8" BSP	Z RHVS 10 R 3/8	*
12	S	3/8" BSP	Z RHVS 12 R 3/8	*
14	S	1/2" BSP	Z RHVS 14 R 1/2	*
16	S	1/2" BSP	Z RHVS 16 R 1/2	*
20	S	3/4" BSP	Z RHVS 20 R 3/4	*
25	S	1" BSP	Z RHVS 25 R 1	*
30	S	1"1/4 BSP	Z RHVS 30 R 1 1/4	*
38	S	1"1/2 BSP	Z RHVS 38 R 1 1/2	*

Setting 1 bar. For other standard spring pressures, consult us. / Taraje 1 bar. Para otras presiones de tarado estandard, consultar. / Einstellung-Druck 1 bar. Bitte kontaktieren Sie uns für andere Standard-Drucke. / Taraje 1 bar. Pour d'autres pressions ressort standard, consultez-nous.

Non-return valve tube-tube

Válvula antirretorno tubo-tubo

Rückschlagventil beidseitiger Rohranschluß

Clapet anti-rétour bidirectionnel tube-tube



TUBO PIPE	SERIE SERIES	Referencia Part n°	€	Referencia STA Part N° STA	€
6	L	Z RHDL 6	44,00	Z STA RHDL 6	35,40
8	L	Z RHDL 8	62,07	Z STA RHDL 8	52,34
10	L	Z RHDL 10	55,34	Z STA RHDL 10	43,62
12	L	Z RHDL 12	66,00	Z STA RHDL 12	52,85
15	L	Z RHDL 15	77,15	Z STA RHDL 15	60,18
18	L	Z RHDL 18	108,53	Z STA RHDL 18	85,15
22	L	Z RHDL 22	145,79	Z STA RHDL 22	115,24
28	L	Z RHDL 28	250,79	Z STA RHDL 28	193,19
35	L	Z RHDL 35	577,04	Z STA RHDL 35	482,83
42	L	Z RHDL 42	748,53	Z STA RHDL 42	632,64
6	S	Z RHDS 6	44,31	Z STA RHDS 6	34,24
8	S	Z RHDS 8	47,03	Z STA RHDS 8	36,11
10	S	Z RHDS 10	57,49	Z STA RHDS 10	43,76
12	S	Z RHDS 12	67,02	Z STA RHDS 12	52,19
14	S	Z RHDS 14	84,06	Z STA RHDS 14	62,16
16	S	Z RHDS 16	98,52	Z STA RHDS 16	74,39
20	S	Z RHDS 20	130,28	Z STA RHDS 20	96,29
25	S	Z RHDS 25	211,46	Z STA RHDS 25	139,28
30	S	Z RHDS 30	344,18	Z STA RHDS 30	248,56
38	S	Z RHDS 38	737,54	Z STA RHDS 38	601,24

Setting 1 bar. For other standard spring pressures, consult us. / Taraje 1 bar. Para otras presiones de tarado estandard, consultar. / Einstellung-Druck 1 bar. Bitte kontaktieren Sie uns für andere Standard-Drucke. / Taraje 1 bar. Pour d'autres pressions ressort standard, consultez-nous.

Non-return valve flow towards male stud end BSP cylindrical

Válvula antirretorno tubo-rosca BSP

Rückschlagventil einseitig sperrend BSP Rohr Stecker (m)

Clapet anti-rétour unidirectionnel à droite tube-mâle



TUBO PIPE	SERIE SERIES	ROSCA THREAD	Referencia Part n°	€
6	L	1/8" BSP	Z RHZL 6 R 1/8	*
8	L	1/4" BSP	Z RHZL 8 R 1/4	*
10	L	1/4" BSP	Z RHZL 10 R 1/4	*
12	L	3/8" BSP	Z RHZL 12 R 3/8	*
15	L	1/2" BSP	Z RHZL 15 R 1/2	*
18	L	1/2" BSP	Z RHZL 18 R 1/2	*
22	L	3/4" BSP	Z RHZL 22 R 3/4	*
28	L	1" BSP	Z RHZL 28 R 1	*
35	L	1"1/4 BSP	Z RHZL 35 R 1 1/4	*
42	L	1"1/2 BSP	Z RHZL 42 R 1 1/2	*
6	S	1/4" BSP	Z RHZS 6 R 1/4	*
8	S	1/4" BSP	Z RHZS 8 R 1/4	*
10	S	3/8" BSP	Z RHZS 10 R 3/8	*
12	S	3/8" BSP	Z RHZS 12 R 3/8	*
14	S	1/2" BSP	Z RHZS 14 R 1/2	*
16	S	1/2" BSP	Z RHZS 16 R 1/2	*
20	S	3/4" BSP	Z RHZS 20 R 3/4	*
25	S	1" BSP	Z RHZS 25 R 1	*
30	S	1"1/4 BSP	Z RHZS 30 R 1 1/4	*
38	S	1"1/2 BSP	Z RHZS 38 R 1 1/2	*

Setting 1 bar. For other standard spring pressures, consult us. / Taraje 1 bar. Para otras presiones de tarado estandard, consultar. / Einstellung-Druck 1 bar. Bitte kontaktieren Sie uns für andere Standard-Drucke. / Taraje 1 bar. Pour d'autres pressions ressort standard, consultez-nous.

Incorporamos válvulas antirretorno sin tuerca ni anillo

Non-return valve only body

FLARE FITTINGS JIC 37°

Racores JIC 37°
JIC - Verbindungen
Adapteurs JIC 37°

Nut JIC 37°

Tuercas JIC 37°

Muttern JIC 37° - M JIC

Écrou JIC 37°



TUBO PIPE	ROSCA THREAD	Referencia Part n°	€	
6	1/4"	ZS11006	5,58	
8	5/16"	ZS11008	4,71	
10	3/8"	ZS11010	5,25	
12	1/2"	ZS11012	5,37	
14-15-16	5/8"	ZS11016	6,80	
18-20	-	1"1/16 12h UN	ZS11020	11,67
-	3/4"	1"1/16 12h UNF	ZS11020W	19,43
25	1"	1"5/16 12h UN	ZS11025	20,35
30-32	1 1/4"	1"5/8 12h UN	ZS11032	27,71
38	1 1/2"	1"7/8 12h UN	ZS11038	51,29

Metric tube sleeves JIC 37°

Ferulas JIC 37° (tubo Métrico)

Druckring (Stützring) metr.

Ferrules JIC 37° pour tube Métrique



TUBO PIPE	Referencia Part n°	€
6	ZS12006	2,86
8	ZS12008	3,09
10	ZS12010	3,80
12	ZS12012	3,90
14	ZS12014	6,59
15	ZS12015	6,59
16	ZS12016	6,33
18	ZS12018	8,04
20	ZS12020	7,73
25	ZS12025	12,18
30	ZS12030	15,72
32	ZS12032	17,12
38	ZS12038	26,75

Tube sleeves Gas JIC 37°

Ferulas JIC 37° (tubo Gas)

Druckring (Stützring) GAS

Ferrules JIC 37° pour tube Gaz



TUBO PIPE	Referencia Part n°	€
1/4"	ZS12104	3,66
5/16"	ZS12105	4,02
3/8"	ZS12106	4,76
1/2"	ZS12108	5,52
5/8"	ZS12110	5,63
3/4"	ZS12112	8,04
1"	ZS12116	18,83
1"1/4	ZS12120	25,50
1"1/2	ZS12124	34,16

Plug male JIC 37°

Tapón macho JIC 37°

Verschlussstopfen JIC 37°

Bouchon mâle JIC 37°



TUBO PIPE	ROSCA THREAD	Referencia Part n°	€	
6	1/4"	ZS14006	7,85	
8	5/16"	ZS14008	7,93	
10	3/8"	ZS14010	12,57	
12	1/2"	ZS14012	14,02	
14-15-16	5/8"	7/8" 14h UNF	ZS14016	15,96
18-20	3/4"	1"1/16 12h UN	ZS14020	23,16
25	1"	1"5/16 12h UN	ZS14025	28,99
30-32	1 1/4"	1"5/8 12h UN	ZS14032	48,24
38	1 1/2"	1"7/8 12h UN	ZS14038	71,90

Cap JIC 37°

Tapón hembra giratoria JIC 37°

Verschlussmutter JIC 37°

Bouchon femelle JIC 37°



TUBO PIPE	ROSCA THREAD	Referencia Part n°	€	
6	1/4"	7/16"-20h UNF	ZS13006	15,47
8	5/16"	1/2"-20h UNF	ZS13008	15,95
10	3/8"	9/16"-18h UNF	ZS13010	14,87
12	1/2"	3/4"-16h UNF	ZS13012	18,61
14-15-16	5/8"	7/8"-14h UNF	ZS13016	17,62
18-20	3/4"	1"1/16-12h UN	ZS13020	25,31
25	1"	1"5/16-12h UN	ZS13025	44,91
30-32	1 1/4"	1"5/8-12h UN	ZS13032	62,87
38	1 1/2"	1"7/8-12h UN	ZS13038	105,84

FLARE FITTINGS JIC 37°

Racores JIC 37°
JIC - Verbindungen
Adpteurs JIC 37°

Straight union JIC 37°

Racor macho-macho JIC 37°

Gerade Verschraubung AGJ-AGJ

Adpteur droit mâle JIC 37°



TUBO PIPE	ROSCA THREAD		Referencia Part n°	€
6	1/4"	7/16" 20h UNF	ZS26006	13,25
8	5/16"	1/2" 20h UNF	ZS26008	15,01
10	3/8"	9/16" 18h UNF	ZS26010	15,21
12	1/2"	3/4" 16h UNF	ZS26012	17,26
14-15-16	5/8"	7/8" 14h UNF	ZS26016	22,93
18-20	3/4"	1"1/16 12h UN	ZS26020	24,59
25	1"	1"5/16 12h UN	ZS26025	36,52
30-32	1" 1/4	1"5/8 12h UN	ZS26032	57,42
38	1" 1/2	1"7/8 12h UN	ZS26038	74,39
50	2"	2" 1/2 12h UN	ZS26050	135,02

Reducer adaptor male JIC 37°

Racor reducción macho-macho JIC 37°

Reduzieranschlüsse m - m JIC 37°

Adpteur réduction mâle JIC 37°



TUBO PIPE	ROSCA THREAD		Referencia Part n°	€
85/16"	61/4"	1/2"20hUNF 7/16"20hUNF	ZS2600806	15,02
105/16"	61/4"	9/16"20hUNF 7/16"20hUNF	ZS2601006	19,59
103/8"	85/16"	9/16"20hUNF 1/2"20hUNF	ZS2601008	18,26
121/2"	103/8"	3/4"20hUNF 9/16"20hUNF	ZS2601210	24,63
14-15-165/8"	121/2"	7/8"20hUNF 3/4"20hUNF	ZS2601612	25,36
18-203/4"	14-15-165/8"	1"1/1620hUNF 7/8"20hUNF	ZS2602016	29,50
251"	18-203/4"	1"5/1620hUNF 1"1/1620hUNF	ZS2602520	40,13
30-321"1/4	251"	1"5/820hUNF 1"5/1620hUNF	ZS2603225	57,42
381"1/2	30-321"1/4	1"7/820hUNF 1"5/820hUNF	ZS2603832	86,26

Straight bulkhead fitting JIC 37°

Racor pasatabiques JIC 37°

Schottverschraubung - SV JIC 37°

Union passe cloison droite mâle JIC 37° équipé



TUBO PIPE	ROSCA THREAD		Referencia Part n°	€
6	1/4"	7/16" 20h UNF	ZS25006	22,67
8	5/16"	1/2" 20h UNF	ZS25008	24,63
10	3/8"	9/16" 18h UNF	ZS25010	25,92
12	1/2"	3/4" 16h UNF	ZS25012	29,34
14-15-16	5/8"	7/8" 14h UNF	ZS25016	36,70
18-20	3/4"	1"1/16 12h UN	ZS25020	52,89
25	1"	1"5/16 12h UN	ZS25025	70,36
30-32	1" 1/4	1"5/8 12h UN	ZS25032	120,18
38	1" 1/2	1"7/8 12h UN	ZS25038	138,99

Straight union JIC 37° with o'ring

Racor macho-macho JIC 37° con junta

Gerade Verschraubung AGJ-AGJ mit Dichtung

Adpteur droit mâle JIC 37° avec o'ring



TUBO PIPE	ROSCA THREAD		Referencia Part n°	€
6	1/4"	7/16" 20h UNF	ZS260060R	20,44
8	5/16"	1/2" 20h UNF	ZS260080R	20,28
10	3/8"	9/16" 18h UNF	ZS260100R	20,29
12	1/2"	3/4" 16h UNF	ZS260120R	24,65
14-15-16	5/8"	7/8" 14h UNF	ZS260160R	28,69
18-20	3/4"	1"1/16 12h UN	ZS260200R	44,28
25	1"	1"5/16 12h UN	ZS260250R	54,12
30-32	1" 1/4	1"5/8 12h UN	ZS260320R	84,94
38	1" 1/2	1"7/8 12h UN	ZS260380R	125,44

Metric adaptor male - male JIC 37°

Racor macho JIC 37° - macho Métrico

Gerade Einschraubversch. JIC 37° -AG metr.

Adpteur mâle JIC 37° - mâle Métrique



TUBO PIPE	ROSCA THREAD		Referencia Part n°	€
6	1/4"	M10x1 7/16" 20h UNF	ZS2400610	19,58
8	5/16"	M10x1 1/2" 20h UNF	ZS2400810*	18,05
8	5/16"	M12x1.5 1/2" 20h UNF	ZS2400812	17,82
8	5/16"	M14x1.5 1/2" 20h UNF	ZS2400814*	14,91
10	3/8"	M12x1.5 9/16" 18h UNF	ZS2401012	21,12
10	3/8"	M14x1.5 9/16" 18h UNF	ZS2401014	25,36
10	3/8"	M16x1.5 9/16" 18h UNF	ZS2401016	21,25
12	1/2"	M14x1.5 3/4" 16h UNF	ZS2401214	24,92
12	1/2"	M16x1.5 3/4" 16h UNF	ZS2401216	22,25
12	1/2"	M18x1.5 3/4" 16h UNF	ZS2401218	22,14
14-15-16	5/8"	M18x1.5 7/8" 14h UNF	ZS2401418	41,97
14-15-16	5/8"	M27x2 7/8" 14h UNF	ZS2401427*	23,94
14-15-16	5/8"	M22x1.5 7/8" 14h UNF	ZS2401622	44,16
18-20	3/4"	M22x1.5 1"1/16 12h UN	ZS2402022	44,16
18-20	3/4"	M27X2 1"1/16 12h UN	ZS2402027	45,50
25	1"	M27x2 1"5/16 12h UNF	ZS2402527*	53,06
25	1"	M33x2 1"5/16 12h UN	ZS2402533	56,77
30-32	1" 1/4	M42x2 1"5/8 12h UN	ZS2403242	92,21
38	1" 1/2	M50x2 1"7/8 12h UN	ZS2403850	134,52

*Until end of stock / Hasta fin de existencias / Bis zum Ende des Lagerbestandes / Jusqu' à la fin du stock

FLARE FITTINGS JIC 37°

Racores JIC 37°
JIC - Verbindungen
Adapteurs JIC 37°

CRIMPING FITTINGS
FOR HOSES

Straight adaptor male JIC 37° - male NPT pipe

Racor macho JIC 37° - macho NPT

Gerade Einschraubversch. AGJ-AGN

Adapteur mâle JIC 37° - mâle NPT (BRIGGS)



TUBO PIPE	ROSCA THREAD	Referencia Part n°	€
6	1/4" 7/16" 20h UNF 1/8" NPT	ZS2000610	14,11
6	1/4" 7/16" 20h UNF 1/4" NPT	ZS2000613	10,81
8	5/16" 1/2" 20h UNF 1/8" NPT	ZS2000810	9,78
8	5/16" 1/2" 20h UNF 1/4" NPT	ZS2000813	13,99
8	5/16" 1/2" 20h UNF 3/8" NPT	ZS2000817	23,24
10	3/8" 9/16" 18h UNF 1/8" NPT	ZS2001010	16,16
10	3/8" 9/16" 18h UNF 1/4" NPT	ZS2001013	12,26
10	3/8" 9/16" 18h UNF 3/8" NPT	ZS2001017	14,47
10	3/8" 9/16" 18h UNF 1/2" NPT	ZS2001021	21,10
12	1/2" 3/4" 16h UNF 1/4" NPT	ZS2001213	22,33
12	1/2" 3/4" 16h UNF 3/8" NPT	ZS2001217	16,63
12	1/2" 3/4" 16h UNF 1/2" NPT	ZS2001221	19,36
12	1/2" 3/4" 16h UNF 3/4" NPT	ZS2001226	22,60
14-15-16	5/8" 7/8" 14h UNF 1/2" NPT	ZS2001621	27,32
14-15-16	5/8" 7/8" 14h UNF 3/4" NPT	ZS2001626	29,33
18-20	3/4" 1" 1/16 12h UN 1/4" NPT	NEW ZS2002013	39,17
18-20	3/4" 1" 1/16 12h UN 1/2" NPT	ZS2002021	26,34
18-20	3/4" 1" 1/16 12h UN 3/4" NPT	ZS2002026	28,80
18-20	3/4" 1" 1/16 12h UN 1" NPT	ZS2002033	40,93
25	1" 1" 5/16 12h UN 3/4" NPT	ZS2002526	37,03
25	1" 1" 5/16 12h UN 1" NPT	ZS2002533	36,50
30-32	1" 1" 5/16 12h UN 1" 1/4 NPT	ZS2002542	80,37
30-32	1" 1/4 1" 5/8 12h UN 1" NPT	ZS2003233	75,91
30-32	1" 1/4 1" 5/8 12h UN 1 1/4" NPT	ZS2003242	70,35
38	1" 1/2 1" 7/8 12h UN 1" NPT	NEW ZS2003833	84,30
38	1" 1/2 1" 7/8 12h UN 1 1/4" NPT	ZS2003842	84,53
38	1" 1/2 1" 7/8 12h UN 1 1/2" NPT	ZS2003848	72,10
50	2" 2" 1/2 12h UN 2" NPT	NEW ZS2005060	117,92

Straight adaptor swivel female JIC 37° - male UNF

Hembra giratoria JIC 37° - macho UNF

Dichtkonus JIC 37° - UNF m

Adapteur femelle tournante JIC 37° - mâle UNF



TUBO PIPE	ROSCA THREAD	Referencia Part n°	€
6	1/4" 7/16" 20h UNF 7/16" 20h UNF	ZS38006	*
10	3/8" 9/16" 18h UNF 9/16" 18h UNF	ZS38010	*
12	1/2" 3/4" 16h UNF 3/4" 16h UNF	ZS38012	*
14-15-16	5/8" 7/8" 14h UNF 7/8" 14h UNF	ZS38016	*
18-20	3/4" 1" 1/16 12h UN 1" 1/16 12h UN	ZS38020	*
25	1" 1" 5/16 12h UN 1" 5/16 12h UN	ZS38025	*

*See prices in p. 188 (O'RING BOSS ADAPTORS) / *Ver precios en p. 188 (ADAPTADORES O'RING BOSS) / *Vgl. Sie die Preise auf S.188 (ADAPTER O'RING BOSS) / *Voir prix à la p. 188 (ADAPTEURS O'RING BOSS)

Straight adaptor male JIC 37° - male BSP

Racor macho JIC 37° - macho BSP

Gerade Einschraubversch. AGJ-AGR

Adapteur mâle JIC 37° - mâle BSP équipé



TUBO PIPE	ROSCA THREAD	TUBO PIPE	ROSCA THREAD	Referencia Part n°	€
6	1/8" BSP 1/4" 7/16" 20h UNF			ZS2300610	11,40
6	1/4" BSP 1/4" 7/16" 20h UNF			ZS2300613	13,14
6	3/8" BSP 1/4" 7/16" 20h UNF			ZS2300617	21,16
6	1/2" BSP 1/4" 7/16" 20h UNF			ZS2300621	40,82
8	1/4" BSP 5/16" 1/2" 20h UNF			ZS2300813	20,41
8	3/8" BSP 5/16" 1/2" 20h UNF			ZS2300817	22,50
10	1/4" BSP 3/8" 9/16" 18h UNF			ZS2301013	14,53
10	3/8" BSP 3/8" 9/16" 18h UNF			ZS2301017	14,32
10	1/2" BSP 3/8" 9/16" 18h UNF			ZS2301021	22,44
12	1/4" BSP 1/2" 3/4" 16h UNF			ZS2301213	19,04
12	3/8" BSP 1/2" 3/4" 16h UNF			ZS2301217	17,45
12	1/2" BSP 1/2" 3/4" 16h UNF			ZS2301221	19,40
12	3/4" BSP 1/2" 3/4" 16h UNF			ZS2301226	36,61
14-15-16	3/8" BSP 5/8" 7/8" 14h UNF			ZS2301617	25,16
14-15-16	1/2" BSP 5/8" 7/8" 14h UNF			ZS2301621	24,29
14-15-16	3/4" BSP 5/8" 7/8" 14h UNF			ZS2301626	35,26
18-20	1/2" BSP 3/4" 1" 1/16 12h UN			ZS2302021	30,59
18-20	3/4" BSP 3/4" 1" 1/16 12h UN			ZS2302026	26,73
18-20	1" BSP 3/4" 1" 1/16 12h UN			ZS2302033	56,46
25	1/2" BSP 1" 1" 5/16 12h UN			ZS2302521*	37,97
25	3/4" BSP 1" 1" 5/16 12h UN			ZS2302526	36,51
25	1" BSP 1" 1" 5/16 12h UN			ZS2302533	52,92
25	1" 1/4 BSP 1" 1" 5/16 12h UN			ZS2302542	71,67
30-32	1" 1/4 BSP 1 1/4" 1" 5/8 12h UN			ZS2303242	76,19
38	1" 1/4 BSP 1 1/2" 1" 7/8 12h UN			ZS2303842	94,18
38	1" 1/2 BSP 1 1/2" 1" 7/8 12h UN			ZS2303848	118,14
38	2" BSP 1 1/2" 1" 7/8 12h UN			ZS2303860	161,41

*Until end of stock / Hasta fin de existencias / Bis zum Ende des Lagerbestandes / Jusqu'à la fin du stock

Straight adaptor male BSP - swivel female JIC 37°

Racor macho BSP - hembra giratoria JIC 37°

Adapter DKJ-AGR

Adapteur mâle BSP - femelle tournante JIC 37°



TUBO PIPE	ROSCA THREAD	Referencia Part n°	€
6	1/4" 1/8" BSP 7/16" 20h UNF	ZS1800610	22,30
8	5/16" 1/4" BSP 1/2" 20h UNF	ZS1800813	23,99
10	3/8" 1/4" BSP 9/16" 18h UNF	ZS1801013	19,39
10	3/8" 3/8" BSP 9/16" 18h UNF	ZS1801017	24,32
10	3/8" 1/2" BSP 9/16" 18h UNF	ZS1801021	29,28
12	1/2" 3/8" BSP 3/4" 16h UNF	ZS1801217	23,37
14-15-16	5/8" 1/2" BSP 7/8" 14h UNF	ZS1801621	28,35
18-20	3/4" 3/4" BSP 1" 1/16 12h UNF	ZS1802026	42,08
25	1" 1" BSP 1" 5/16 12h UNF	ZS1802533	66,67
30-32	1" 1/4 1" 1/4 BSP 1" 5/8 12h UNF	ZS1803242	112,67
38	1" 1/2 1" 1/2 BSP 1" 7/8 12h UNF	ZS1803848	164,49

PIPE FITTINGS

PIPE FITTINGS II

ADAPTORS

WELDING FITTINGS

INDUSTRIAL FITTINGS

ACCESSORIES

CONTROL COMPONENTS

FLOW MEASURING

TRALE LOK

FLARE FITTINGS JIC 37°

Racores JIC 37°
JIC - Verbindungen
Adpteurs JIC 37°

Straight adaptor male JIC 37° - male BSPT

Racor macho JIC 37° - macho BSPT

Gerade Einschraubverschr. AGJ-AGR KEGEL

Adpteur mâle JIC 37° - mâle BSPT



TUBO PIPE	ROSCA THREAD		Referencia Part n°	€
6	1/4"	7/16" 20h UNF	1/8" BSPT	ZS2100610 15,57
6	1/4"	7/16" 20h UNF	1/4" BSPT	ZS2100613 13,05
8	5/16"	1/2" 20h UNF	1/8" BSPT	ZS2100810 13,77
8	5/16"	1/2" 20h UNF	1/4" BSPT	ZS2100813 15,28
8	5/16"	1/2" 20h UNF	3/8" BSPT	ZS2100817 14,09
10	3/8"	9/16" 18h UNF	1/4" BSPT	ZS2101013 15,08
10	3/8"	9/16" 18h UNF	3/8" BSPT	ZS2101017 17,56
10	3/8"	9/16" 18h UNF	1/2" BSPT	ZS2101021 21,50
12	1/2"	3/4" 16h UNF	1/4" BSPT	ZS2101213 19,47
12	1/2"	3/4" 16h UNF	3/8" BSPT	ZS2101217 17,85
12	1/2"	3/4" 16h UNF	1/2" BSPT	ZS2101221 17,24
12	1/2"	3/4" 12h UNF	3/4" BSPT	ZS2101226 23,46
14-15-16	5/8"	7/8" 14h UNF	3/8" BSPT	ZS2101617 23,76
14-15-16	5/8"	7/8" 14h UNF	1/2" BSPT	ZS2101621 23,04
14-15-16	5/8"	7/8" 14h UNF	3/4" BSPT	ZS2101626 27,73
18-20	3/4"	1" 1/16 12h UN	1/2" BSPT	ZS2102021 28,74
18-20	3/4"	1" 1/16 12h UN	3/4" BSPT	ZS2102026 28,56
18-20	3/4"	1" 1/16 12h UN	1" BSPT	ZS2102033 40,23
25	1"	1" 5/16 12h UN	3/4" BSPT	ZS2102526 45,12
25	1"	1" 5/16 12h UN	1" BSPT	ZS2102533 37,60
30-32	1" 1/4	1" 5/8 12h UN	1" BSPT	ZS2103233 59,70
30-32	1" 1/4	1" 5/8 12h UN	1 1/4" BSPT	ZS2103242 62,88
38	1" 1/2	1" 7/8 12h UN	1 1/2" BSPT	ZS2103848 82,09

Adaptor male JIC - swivel female JIC

Adaptador Macho JIC - hembra giratoria JIC 37°

JIC m - w Ü-Mutter JIC

Adpteur mâle JIC x femelle tournante JIC



PIPE TUBO	THREAD ROSCA		Part n° Referencia	€
6	1/4"	7/16" 20 UNF	7/16" 20 UNF	ZS7400606 16,82
8	5/16"	1/2" 20 UNF	1/2" 20 UNF	ZS7400808 19,08
10	3/8"	9/16" 18 UNF	9/16" 18 UNF	ZS7401010 22,83
12	1/2"	3/4" 16 UNF	3/4" 16 UNF	ZS7401212 25,36
14-15-16	5/8"	7/8" 14 UNF	7/8" 14 UNF	ZS7401616 30,43
18-20	3/4"	1" 1/16 12 UNF	1" 1/16 12 UNF	ZS7402020 39,83
25	1"	1" 5/16 12 UNF	1" 5/16 12 UNF	ZS7402525 52,18

Straight adaptor male JIC 37° - fixed female NPT

Racor macho JIC 37° - hembra fija NPT

Gerade Einschraubverschr. m JIC 37° - w fest NPT

Adpteur mâle JIC 37° - femelle fixe NPT



TUBO PIPE	ROSCA THREAD		Referencia Part n°	€
6	1/4"	7/16"-20h UNF	1/8 NPT	ZS2950610 18,58
6	1/4"	7/16"-20h UNF	1/4 NPT	ZS2950613 25,32
8	5/16"	1/2"-20h UNF	1/4 NPT	ZS2950813 27,37
8	5/16"	1/2"-20h UNF	3/8 NPT	ZS2950817 *
10	3/8"	9/16"-20h UNF	1/4 NPT	ZS2951013 30,94
10	3/8"	9/16"-20h UNF	3/8 NPT	ZS2951017 32,85
12	1/2"	3/4"-20h UNF	1/4 NPT	ZS2951213 25,45
12	1/2"	3/4"-20h UNF	3/8 NPT	ZS2951217 23,57
12	1/2"	3/4"-20h UNF	1/2" NPT	ZS2951221 33,95
14-15-16	5/8"	7/8"-14h UNF	1/2" NPT	ZS2951621 36,73
18-20	3/4"	1" 1/16-12h UNF	3/4" NPT	ZS2952026 43,05
18-20	3/4"	1" 1/16-12h UNF	1" NPT	ZS2952033 *
25	1"	1" 5/16-12 UNF	1" NPT	ZS2952533 59,12
25	1"	1" 5/16-12 UN	1" 1/4 NPT	ZS2952542 *

FLARE FITTINGS JIC 37°

Racores JIC 37°
JIC - Verbindungen
Adapteurs JIC 37°

Reducer adaptor male JIC 37° -swivel female JIC 37°



Racor reducción macho JIC 37° - hembra giratoria JIC 37°

Reduziernippel m - w Ü-Mutter JIC 37°

Adapteur réduction mâle JIC 37° - femelle tournante JIC 37°



ROSCA (H) THREAD (F)	ROSCA (M) THREAD (M)	TUBO (H) PIPE (F)	TUBO (M) PIPE (M)	Referencia Part n°	€
9/16" 18h UNF	7/16" 20h UNF	10	6	ZS2911006	18,06
9/16" 18h UNF	3/4" 16h UNF	10	12	ZS2911012	36,33
9/16" 18h UNF	7/8" 14h UNF	10	14-15-16	ZS2911016	30,39
3/4" 16h UNF	7/16" 20h UNF	12	6	ZS2911206	19,81
3/4" 16h UNF	1/2" 20h UNF	12	8	ZS2911208	22,52
3/4" 16h UNF	9/16" 18h UNF	12	10	ZS2911210	27,00
3/4" 16h UNF	1 1/16" 12h UN	12	18-20	ZS2911220	40,62
3/4" 16h UNF	1 5/16 12h UN	12	25	ZS2911225	45,46
7/8" 14h UNF	7/16" 20h UNF	14-15-16	6	ZS2911606	23,54
7/8" 14h UNF	9/16" 18h UNF	14-15-16	10	ZS2911610	26,42
7/8" 14h UNF	1 1/16 12h UN	14-15-16	18-20	ZS2911620	37,27
1 1/16 12h UN	7/16" 20h UNF	18-20	6	ZS2912006	35,90
1 1/16 12h UN	9/16" 18h UNF	18-20	10	ZS2912010	32,17
1 1/16 12h UN	3/4" 16h UNF	18-20	12	ZS2912012	30,41
1 5/16 12h UN	1 1/16" 12h UN	25	18-20	ZS2912520	54,17
7/8" 14h UNF	1" 5/8 12h UN	32	16	ZS2913216	73,51
1 1/16 12h UN	1" 5/8 12h UN	32	20	ZS2913220	66,65
1 5/8 12h UN	1 5/16 12h UN	30-32	25	ZS2913225	68,85

Material could be delivered with loose or crimped nut / Pueden ser suministradas con tuerca libre o prensada / Material could be delivered with loose or crimped nut / Peut être livrée avec écrou libre ou pré-serti

Reducer adaptor male JIC 37° - fixed female JIC 37°

Racor reducción macho JIC 37 - hembra fija JIC 37°

Reduzieranschlüsse m - w JIC 37°

Adapteur réduction mâle JIC 37° - femelle fixe JIC 37°



TUBO (H) PIPE (F)	TUBO (M) PIPE (M)	ROSCA (H) THREAD (F)	ROSCA (M) THREAD (M)	Referencia Part n°	€
6	8	7/16" 20h UNF	1/2" 20h UNF	ZS2900608	15,44
6	12	7/16" 20h UNF	3/4" 16h UNF	ZS2900612	*
6	25	7/16" 20h UNF	1 5/16 12h UN	ZS2900625	*
8	14-15-16	1/2" 20h UNF	7/8" 14h UNF	ZS2900816	*
8	18-20	1/2" 20h UNF	1 1/16 12h UN	ZS2900820	*
8	25	1/2" 20h UNF	1 5/16 12h UN	ZS2900825	*
10	8	9/16" 18h UNF	1/2" 20h UNF	ZS2901008	25,73
10	25	9/16" 18h UNF	1 5/16 12h UN	ZS2901025	*
12	30-32	3/4" 16h UNF	1 5/8 12h UN	ZS2901232	*
12	38	3/4" 16h UNF	1 7/8 12h UN	ZS2901238	*
14-15-16	12	7/8" 14h UNF	3/4" 16h UNF	ZS2901612	27,81
14-15-16	25	7/8" 14h UNF	1 5/16 12h UN	ZS2901625	*
14-15-16	30-32	7/8" 14h UNF	1 5/8 12h UN	ZS2901632	*
14-15-16	38	7/8" 14h UNF	1 7/8 12h UN	ZS2901638	*
18-20	30-32	1 1/16 12h UN	1 5/16 12h UN	ZS2902025	*
18-20	30-32	1 1/16 12h UN	1 5/8 12h UN	ZS2902032	65,48
25	30-32	1 5/16 12h UN	1 5/8 12h UN	ZS2902532	*
25	38	1 5/16 12h UN	1 7/8 12h UN	ZS2902538	76,81
38	30-32	1 7/8 12h UN	1 5/8 12h UN	ZS2903832	133,97

FLARE FITTINGS JIC 37°

Racores JIC 37°
JIC - Verbindungen
Adpteurs JIC 37°

Straight adaptor swivel female JIC 37° - male NPT pipe

Hembra giratoria JIC 37° - macho NPT

Dichtkopf mit Ü-Mutter JIC 37° - NPT m

Adapteur femelle tournante JIC 37° - mâle NPT



ROSCA THREAD		Referencia Part n°	€
7/16"-20h UNF	1/4" NPT	ZS1850613	25,91
9/16"-18h UNF	3/8" NPT	ZS1851017	25,44
3/4"-16h UNF	3/8" NPT	ZS1851217	25,43
3/4"-16h UNF	1/2" NPT	ZS1851221	37,23
7/8"-14h UNF	1/2" NPT	ZS1851621	34,23
1"1/16-12h UNF	3/4" NPT	ZS1852026	38,67
1"5/16-12h UNF	1" NPT	ZS1852533	68,38
1" 7/8-12h UN	1" 1/2 NPT	NEW ZS1853848	130,06

FKM green o'ring for Metric thread

Juntas tóricas FKM verde para macho Métrico

O-Ringe FKM grün für metr. Verb.

Joint torique FKM vert pour filetage métrique



ROSCA THREAD	Referencia Part n°	€
M10x1	JVMET10	0,24
M14x1.5	JVMET14	0,32
M16x1.5	JVMET16	0,37
M18x1.5	JVMET18	0,46
M22x1.5	JVMET22	0,54
M27x2	JVMET27	0,71
M33x2	JVMET33	1,71
M42x2	JVMET42	3,23
M50x2	JVMET50	1,50

FKM green o'ring for UNF thread

Juntas tóricas FKM verde para rosca UNF

O- Ringe FKM grün für UNF

Joint torique FKM vert pour filetage UNF



ROSCA THREAD	Referencia Part n°	€
7/16" UNF	JVUNF06	0,36
1/2" UNF	JVUNF08	0,61
9/16" UNF	JVUNF10	0,92
3/4" UNF	JVUNF12	0,87
7/8" UNF	JVUNF16	1,13
1" 1/16 UNF	JVUNF20	1,31
1"5/16 UNF	JVUNF25	3,16
1" 5/8 UNF	JVUNF32	5,05
1" 7/8 UNF	JVUNF38	4,08

Straight adaptor swivel female JIC 37°

Racor hembra giratoria - hembra giratoria JIC 37°

Adapter JIC 37° W mit Ü-Muttern

Adapteur femelle tournante JIC 37°



TUBO PIPE		ROSCA THREAD	Referencia Part n°	€
6	1/4"	7/16" 20h UNF	ZS73006	22,41
8	5/16"	1/2" 20h UNF	ZS73008	22,78
10	3/8"	9/16" 18h UNF	ZS73010	22,60
12	1/2"	3/4" 16h UNF	ZS73012	24,34
14-15-16	5/8"	7/8" 14h UNF	ZS73016	32,76
18-20	3/4"	1"1/16 12h UN	ZS73020	48,56
25	1"	1"5/16 12h UN	ZS73025	68,23
32	1"1/4	1"5/8 12h UN	ZS73032	124,63
38	1"1/2	1"7/8 12h UN	ZS73038	145,31

FKM green o'ring for BSP thread

Juntas tóricas FKM verde para macho BSP

O-Ringe FKM grün für BSP

Joint torique FKM vert pour mâle BSP



ROSCA THREAD	Referencia Part n°	€
1/8" BSP	JVMBSP02	0,27
1/4" BSP	JVMBSP04	0,37
3/8" BSP	JVMBSP06	0,45
1/2" BSP	JVMBSP08	0,58
3/4" BSP	JVMBSP12	0,71
1" BSP	JVMBSP16	1,56
1"1/4 BSP	JVMBSP20	1,97
1"1/2 BSP	JVMBSP24	2,22
2" BSP	JVMBSP32	3,29

FKM green o'ring for JIC male thread

Juntas para Macho JIC FKM verde

Dichtungen für Außengewinde JIC 37° FKM grün

Joint FKM vert pour mâle JIC



ROSCA THREAD	Referencia Part n°	€
7/16" 20h UNF	JTVJIC07	0,17
9/16" 18h UNF	JTVJIC09	0,17
3/4" 16h UNF	JTVJIC12	0,22
1"1/16 12h UNF	JTVJIC17	0,29
1" 5/16 12h UN	JTVJIC21	0,28
1"5/8 12h UNF	JTVJIC26	0,39

FLARE FITTINGS JIC 37°

Racores JIC 37°
JIC - Verbindungen
Adapteurs JIC 37°

90° Elbow male - male JIC 37°

Codo 90° macho - macho JIC 37°

90° Winkel AGJ-AGJ

Coude 90° mâle - mâle JIC 37°



TUBO PIPE	ROSCA THREAD	Referencia Part n°	€
6	1/4"	7/16" 20h UNF	ZS50006 27,28
8	5/16"	1/2" 20h UNF	ZS50008 29,57
10	3/8"	9/16" 18h UNF	ZS50010 26,31
12	1/2"	3/4" 16h UNF	ZS50012 46,29
14-15-16	5/8"	7/8" 14h UNF	ZS50016 71,16
18-20	3/4"	1"1/16 12h UN	ZS50020 76,72
25	1"	1"5/16 12h UN	ZS50025 94,31
30-32	1"1/4	1"5/8 12h UN	ZS50032 121,03
38	1"1/2	1"7/8 12h UN	ZS50038 214,11

90° Elbow swivel female JIC 37° - male JIC 37°

Codo 90° macho JIC 37° - hembra giratoria JIC 37°

90° Winkel DKJ-AGJ

Coude 90° mâle JIC 37° - femelle tournante JIC 37°



TUBO PIPE	ROSCA THREAD	Referencia Part n°	€
6	1/4" 7/16" 20h UNF	7/16" 20h UNF	ZS67506 32,93
8	5/16" 1/2" 20h UNF	1/2" 20h UNF	ZS67508 33,40
10	3/8" 9/16" 18h UNF	9/16" 18h UNF	ZS67510 31,78
12	1/2" 3/4" 16h UNF	3/4" 16h UNF	ZS67512 49,91
14-15-16	5/8" 7/8" 14h UNF	7/8" 14h UNF	ZS67516 57,46
18-20	3/4" 1"1/16 12h UNF	1"1/16 12h UNF	ZS67520 72,48
25	1" 1"5/16 12h UNF	1"5/16 12h UNF	ZS67525 119,49
30-32	1"1/4 1"5/8 12h UNF	1"5/8 12h UNF	ZS67532 154,29
38	1"1/2 1"7/8 12h UNF	1"7/8 12h UNF	ZS67538 225,04

90° Elbow male JIC 37° - fixed female NPT

Codo 90° macho JIC 37° - hembra fija NPT

90° Winkel m JIC 37° - w fest NPT

Coude 90° JIC 37° - femelle fixe NPT



PIPE TUBO	THREAD ROSCA	Part n° Referencia	€
6	1/4" 7/16" 20h UNF	1/4" NPT	ZS7000613 *
10	3/8" 9/16" 18h UNF	3/8" NPT	ZS7001017 *
12	1/2" 3/4" 16h UNF	1/2" NPT	ZS7001221 *
18-20	3/4" 1"1/16 12h UNF	3/4" NPT	ZS7002026 *
25	1" 1"5/16 12h UNF	1" NPT	ZS7002533 *

*On request / Consultar / Auf Anfrage / Sur demande

90° Elbow male - male JIC 37° with o'ring

Codo 90° macho - macho JIC 37° con junta

90° Winkel m - m JIC 37° mit Dichtung

Coude 90° mâle - mâle JIC 37° avec o'ring



TUBO PIPE	ROSCA THREAD	Referencia Part n°	€
6	1/4" 7/16" 20h UNF	7/16" 20h UNF	ZS50006OR 37,98
8	5/16" 1/2" 20h UNF	1/2" 20h UNF	ZS50008OR 41,14
10	3/8" 9/16" 18h UNF	9/16" 18h UNF	ZS50010OR 39,83
12	1/2" 3/4" 16h UNF	3/4" 16h UNF	ZS50012OR 49,76
14-15-16	5/8" 7/8" 14h UNF	7/8" 14h UNF	ZS50016OR 70,51
18-20	3/4" 1"1/16 12h UN	1"1/16 12h UN	ZS50020OR 94,93
25	1" 1"5/16 12h UN	1"5/16 12h UN	ZS50025OR 137,35
30-32	1"1/4 1"5/8 12h UN	1"5/8 12h UN	ZS50032OR 168,78
38	1"1/2 1"7/8 12h UN	1"7/8 12h UN	ZS50038OR 291,37

90° Bulkhead elbow male - male JIC 37°

Codo 90° pasatabiques macho - macho JIC 37°

90° Schottverschraubung m - m JIC 37°

Coude 90° passe cloison mâle-mâle JIC 37°



TUBO PIPE	ROSCA THREAD	Referencia Part n°	€
6	1/4" 7/16" - 20h UNF	7/16" - 20h UNF	ZS65006 68,13
8	5/16" 1/2" - 20h UNF	1/2" - 20h UNF	ZS65008 80,41
10	3/8" 9/16" - 18h UNF	9/16" - 18h UNF	ZS65010 79,07
12	1/2" 3/4" - 16h UNF	3/4" - 16h UNF	ZS65012 95,93
14-15-16	5/8" 7/8" - 14h UNF	7/8" - 14h UNF	ZS65016 118,74
18-20	3/4" 1"1/16 - 12h UN	1"1/16 - 12h UN	ZS65020 174,76
25	1" 1"5/16 - 12h UN	1"5/16 - 12h UN	ZS65025 208,08

90° Adjustable stud elbow male JIC 37° - male BSP

Codo 90° regulable macho JIC 37° - macho BSP

90° Winkel einstellbar m JIC 37° - m BSP

Coude 90° orientable mâle JIC 37° - mâle BSP



TUBO PIPE	ROSCA THREAD	Referencia Part n°	€
6	1/4" 7/16" 20h UNF	1/4" BSP	ZS5700613 23,46
10	3/8" 9/16 18h UNF	1/4" BSP	ZS5701013 55,69
10	3/8" 9/16" 18h UNF	3/8" BSP	ZS5701017 56,58
12	1/2" 3/4 20h UNF	3/8" BSP	ZS5701217 64,72
12	1/2" 3/4" 16h UNF	1/2" BSP	ZS5701221 54,52
14-15-16	5/8" 7/8" 14h UNF	1/2" BSP	ZS5701621 59,42
18-20	3/4" 1"1/16 12h UN	3/4" BSP	ZS5702026 86,63
25	1" 1"5/16 12h UN	1" BSP	ZS5702533 136,95
30-32	1"1/4 1 5/8 12h UN	1"1/4 BSP	ZS5703242 466,56
38	1"1/2 1"7/8 12h UN	1"1/2 BSP	ZS5703848 825,42

FLARE FITTINGS JIC 37°

Racores JIC 37°
JIC - Verbindungen
Adapteurs JIC 37°

90° Adjustable elbow male O'Ring Boss - male JIC 37°

Codo 90° regulable macho O'Ring Boss - macho JIC 37

90° Winkel einstellbar m O'Ring Boss - m JIC 37°

Coude 90° orientable mâle O'Ring Boss - mâle JIC 37°



TUBO PIPE	ROSCA THREAD		Referencia Part n°	€
6	1/4"	7/16" - 20h UNF	7/16" - 20h UNF	ZS57506 *
8	5/16"	1/2" - 20h UNF	1/2" - 20h UNF	ZS57508 *
10	3/8"	9/16" - 18h UNF	9/16" - 18h UNF	ZS57510 *
12	1/2"	3/4" - 16h UNF	3/4" - 16h UNF	ZS57512 *
14-15-16	5/8"	7/8" - 14h UNF	7/8" - 14h UNF	ZS57516 *
18-20	3/4"	1" 1/16 - 12h UN	1" 1/16 - 12h UN	ZS57520 *
25	1"	1" 5/16 - 12h UN	1" 5/16 - 12h UN	ZS57525 *

*See prices in p. 189 (O'RING BOSS ADAPTORS) / *Ver precios en p. 189 (ADAPTADORES O'RING BOSS) / *Vgl. Sie die Preise auf S.189 (ADAPTER O'RING BOSS) / *Voir prix à la p. 189 (ADAPTEURS O'RING BOSS)

90° Elbow male JIC 37° - male BSPT

Codo 90° macho JIC 37° - macho BSPT

90° Winkel AGJ-AGR KEGEL

Coude 90° mâle JIC 37° - mâle BSPT



TUBO PIPE	ROSCA THREAD		Referencia Part n°	€
6	1/4"	1/8" BSPT	7/16" 20h UNF	ZS5500610 36,72
6	1/4"	1/4" BSPT	7/16" 20h UNF	ZS5500613 37,45
8	5/16"	1/8" BSPT	1/2" 20h UNF	ZS5500810 38,38
8	5/16"	1/4" BSPT	1/2" 20h UNF	ZS5500813 36,48
10	3/8"	1/4" BSPT	9/16" 18h UNF	ZS5501013 32,69
10	3/8"	3/8" BSPT	9/16" 18h UNF	ZS5501017 45,40
10	3/8"	1/2" BSPT	9/16" 18h UNF	ZS5501021 53,60
12	1/2"	1/4" BSPT	3/4" 16h UNF	ZS5501213 51,04
12	1/2"	3/8" BSPT	3/4" 16h UNF	ZS5501217 60,28
12	1/2"	1/2" BSPT	3/4" 16h UNF	ZS5501221 46,70
14-15-16	5/8"	3/8" BSPT	7/8" 14h UNF	ZS5501617 59,26
14-15-16	5/8"	1/2" BSPT	7/8" 14h UNF	ZS5501621 66,64
14-15-16	5/8"	3/4" BSPT	7/8" 14h UNF	ZS5501626 113,10
18-20	3/4"	1/2" BSPT	1" 1/16 12h UN	ZS5502021 77,27
18-20	3/4"	3/4" BSPT	1" 1/16 12h UN	ZS5502026 80,83
25	1"	3/4" BSPT	1" 5/16 12h UN	ZS5502526 141,22
25	1"	1" BSPT	1" 5/16 12h UN	ZS5502533 125,51
30-32	1" 1/4	1 1/4" BSPT	1" 5/8 12h UN	ZS5503242* 226,25

*Until end of stock / Hasta fin de existencias / Bis zum Ende des Lagerbestandes / Jusqu'à la fin du stock

90° Elbow male NPT - swivel female JIC 37°

Codo 90° macho NPT - hembra giratoria JIC 37°

90° Winkel m NPT - W mit Ü-Mutter JIC°

Coude 90° mâle NPT - femelle tournante JIC 37°



ROSCA THREAD	Referencia Part n°	€
1/8" NPT	7/16"-20h UNF	ZS5950610 29,69
1/4" NPT	1/2"-20h UNF	ZS5950813 32,75
1/4" NPT	9/16"-18h UNF	ZS5951013 33,61
3/8" NPT	3/4"-16h UNF	ZS5951217 46,04
1/2" NPT	7/8"-14h UNF	ZS5951621 60,70
3/4" NPT	1" 1/16"-12h UN	ZS5952026 93,33
1" NPT	1" 5/16"-12h UN	ZS5952533 114,48

90° Elbow male JIC 37° - male NPT

Codo 90° macho JIC 37° - macho NPT

90° Winkel AGJ-AGN

Coude 90° mâle JIC 37° - mâle NPT



TUBO PIPE	ROSCA THREAD		Referencia Part n°	€
6	1/4"	1/8" NPT	7/16" 20h UNF	ZS5250610 35,22
6	1/4"	1/4" NPT	7/16" 20h UNF	ZS5250613 33,17
8	5/16"	1/8" NPT	1/2" 20h UNF	ZS5250810 30,11
8	5/16"	1/4" NPT	1/2" 20h UNF	ZS5250813 29,37
10	3/8"	1/4" NPT	9/16" 18h UNF	ZS5251013 27,29
10	3/8"	3/8" NPT	9/16" 18h UNF	ZS5251017 33,84
10	3/8"	1/2" NPT	9/16" 18h UNF	ZS5251021 45,25
12	1/2"	1/4" NPT	3/4" 16h UNF	ZS5251213 41,69
12	1/2"	3/8" NPT	3/4" 16h UNF	ZS5251217 47,62
12	1/2"	1/2" NPT	3/4" 16h UNF	ZS5251221 43,73
14-15-16	5/8"	3/8" NPT	7/8" 14h UNF	ZS5251617 58,82
14-15-16	5/8"	1/2" NPT	7/8" 14h UNF	ZS5251621 45,44
14-15-16	5/8"	3/4" NPT	7/8" 14h UNF	ZS5251626 66,50
18-20	3/4"	1/2" NPT	1" 1/16 12h UN	ZS5252021 76,16
18-20	3/4"	3/4" NPT	1" 1/16 12h UN	ZS5252026 72,25
25	1"	3/4" NPT	1" 5/16 12h UN	ZS5252526 95,33
25	1"	1" NPT	1" 5/16 12h UN	ZS5252533 101,39
30-32	1" 1/4	1 1/4" NPT	1" 5/8 12h UN	ZS5253242* 105,08

*Until end of stock / Hasta fin de existencias / Bis zum Ende des Lagerbestandes / Jusqu'à la fin du stock

FLARE FITTINGS JIC 37°

Racores JIC 37°
JIC - Verbindungen
Adapteurs JIC 37°

45° Elbow male JIC 37° - swivel female JIC 37°

Codo 45° macho JIC 37° - hembra giratoria JIC 37°

45° Winkel m JIC 37° - w Ü-Mutter JIC 37°

Coude 45° mâle JIC 37° - femelle tournante JIC 37°



TUBO PIPE	ROSCA THREAD		Referencia Part n°	€
6	1/4"	7/16" 20h UNF	ZS69006	18,81
8	5/16"	1/2" 20h UNF	ZS69008	22,13
10	3/8"	9/16" 18h UNF	ZS69010	24,31
12	1/2"	3/4" 16h UNF	ZS69012	42,91
14-15-16	5/8"	7/8" 14h UNF	ZS69016	54,52
18-20	3/4"	1" 1/16 12h UN	ZS69020	318,01
25	1"	1"5/16 12h UN	ZS69025	464,73

45° Adjustable stud elbow male - male JIC 37°

Codo 45° regulable macho - macho JIC 37°

45° Winkel JIC 37° m einstellbar - m

Coude 45° orientable mâle - mâle JIC 37°



TUBO PIPE	ROSCA THREAD		Referencia Part n°	€
6	1/4"	7/16" - 20h UNF	ZS77506	74,17
8	5/16"	1/2" - 20h UNF	ZS77508	76,75
10	3/8"	9/16" - 18h UNF	ZS77510	70,47
12	1/2"	3/4" - 16h UNF	ZS77512	87,79
14-15-16	5/8"	7/8" - 14h UNF	ZS77516	160,14
18-20	3/4"	1" 1/16 - 12h UN	ZS77520	333,35

45° Elbow male JIC 37° - male NPT pipe

Codo 45° macho JIC 37° - macho NPT

45° Winkel m JIC 37° - m NPT

Coude 45° mâle JIC 37° - mâle NPT



TUBO PIPE	ROSCA THREAD		Referencia Part n°	€
6	1/4"	1/4" NPT	ZS7250613	17,05
10	3/8"	3/8" NPT	ZS7251017	23,06
12	1/2"	1/2" NPT	ZS7251221	35,09
18-20	3/4"	3/4" NPT	ZS7252026	54,52
25	1"	1" NPT	ZS7252533	88,85

FLARE FITTINGS JIC 37°

Racores JIC 37°
JIC - Verbindungen
Adapteurs JIC 37°

Union tee male JIC 37°

TE macho - macho - macho JIC 37°

T-Verschraubung AGJ

Té égal mâle JIC 37°



TUBO PIPE	ROSCA THREAD	Referencia Part n°	€
6	1/4"	7/16" 20h UNF	ZS50506 40,38
8	5/16"	1/2" 20h UNF	ZS50508 49,26
10	3/8"	9/16" 18h UNF	ZS50510 39,78
12	1/2"	3/4" 16h UNF	ZS50512 61,96
14-15-16	5/8"	7/8" 14h UNF	ZS50516 67,74
18-20	3/4"	1"1/16 12h UN	ZS50520 95,64
25	1"	1"5/16 12h UN	ZS50525 136,77
30-32	1" 1/4	1"5/8 12h UN	ZS50532 202,74
38	1" 1/2	1"7/8 12h UN	ZS50538 311,67

Tee male JIC 37° - male JIC 37° - swivel nut JIC 37°

TE macho - macho - hembra giratoria JIC 37°

Einstellbare T-Anschlußverschraubungen AGJ-AGJ-DKJ

Té mâle JIC 37° - mâle JIC 37° - femelle tournante JIC 37° au latéral



TUBO PIPE	ROSCA THREAD	Referencia Part n°	€
6	1/4"	7/16" 20h UNF	ZS68006 50,27
8	5/16"	1/2" 20h UNF	ZS68008 46,47
10	3/8"	9/16" 18h UNF	ZS68010 44,26
12	1/2"	3/4" 16h UNF	ZS68012 61,90
14-15-16	5/8"	7/8" 14h UNF	ZS68016 72,11
18-20	3/4"	1"1/16 12h UN	ZS68020 97,42
25	1"	1"5/16 12h UN	ZS68025 156,30
32	1" 1/4	1"5/8 12h UN	ZS68032 216,54
38	1" 1/2	1"7/8 12h UN	ZS68038 294,55

Tee male JIC 37° - male JIC 37° - male NPT

TE macho JIC 37° - macho JIC 37° - macho NPT

T-Verschraubungen m JIC 37° - m JIC 37° - m NPT

Té mâle JIC 37° - mâle JIC 37° - mâle NPT



ROSCA THREAD	Referencia Part n°	€
7/16"-20h UNF 7/16"-20h UNF 1/8" NPT	ZS6300610	33,54
1/2"-20h UNF 1/2"-20h UNF 1/4" NPT	ZS6300813	45,16
9/16"-18h UNF 9/16"-18h UNF 1/4" NPT	ZS6301013	54,33
3/4"-16h UNF 3/4"-16h UNF 3/8" NPT	ZS6301217	61,43
7/8"-14h UNF 7/8"-14h UNF 1/2" NPT	ZS6301621	73,06
1"1/16-12h UN 1"1/16-12h UN 3/4" NPT	ZS6302026	109,30
1"5/16-12h UN 1"5/16-12h UN 1" NPT	ZS6302533	121,26

Union tee male JIC 37° with o'ring

TE macho - macho - macho JIC 37° con junta

T-Verschraubungen m - m - m - JIC 37° mit Dichtung

Té égal mâle JIC 37° avec o'ring



TUBO PIPE	ROSCA THREAD	Referencia Part n°	€
6	1/4"	7/16" 20h UNF	ZS505060R 57,36
8	5/16"	1/2" 20h UNF	ZS505080R 52,88
10	3/8"	9/16" 18h UNF	ZS505100R 58,65
12	1/2"	3/4" 16h UNF	ZS505120R 69,61
14-15-16	5/8"	7/8" 14h UNF	ZS505160R 85,36
18-20	3/4"	1"1/16 12h UNF	ZS505200R 119,26
25	1"	1"5/16 12h UN	ZS505250R 179,00
30-32	1" 1/4	1"5/8 12h UN	ZS505320R 222,79
38	1" 1/2	1"7/8 12h UN	ZS505380R 340,46

Tee male JIC 37° - swivel nut JIC 37° - male JIC 37°

TE macho - hembra giratoria - macho JIC 37°

Einstellbare T-Anschlußverschraubung AGJ-DKJ-AGJ

Té mâle JIC 37° - femelle tournante JIC 37° - mâle JIC 37°



TUBO PIPE	ROSCA THREAD	Referencia Part n°	€
6	1/4"	7/16" 20h UNF	ZS68506 53,68
8	5/16"	1/2" 20h UNF	ZS68508 50,77
10	3/8"	9/16" 18h UNF	ZS68510 48,34
12	1/2"	3/4" 16h UNF	ZS68512 63,97
14-15-16	5/8"	7/8" 14h UNF	ZS68516 76,49
18-20	3/4"	1"1/16 12h UN	ZS68520 99,18
25	1"	1"5/16 12h UN	ZS68525 190,61
32	1" 1/4	1"5/8 12h UN	ZS68532 207,16
38	1" 1/2	1"7/8 12h UN	ZS68538 277,86

Tee male JIC 37° - male NPT - male JIC 37°

TE macho JIC 37° - macho NPT - macho JIC 37°

T-Verschraubungen m JIC 37° - m NPT - m JIC 37°

Té mâle JIC 37° - mâle NPT - mâle JIC 37°



ROSCA THREAD	Referencia Part n°	€
7/16"-20h UNF 1/8" NPT 7/16"-20h UNF	ZS6250610	46,95
1/2"-20h UNF 1/4" NPT 1/2"-20h UNF	ZS6250813	50,48
9/16"-18h UNF 1/4" NPT 9/16"-18h UNF	ZS6251013	74,24
3/4"-16h UNF 3/8" NPT 3/4"-16h UNF	ZS6251217	83,04
7/8"-14h UNF 1/2" NPT 7/8"-14h UNF	ZS6251621	94,98
1"1/16-12h UN 3/4" NPT 1"1/16-12h UN	ZS6252026	101,23
1"5/16-12h UN 1" NPT 1"5/16-12h UN	ZS6252533	121,26

EVERYTHING BEGINS WITH AN IDEA

TECHNICAL DEPARTMENT

NUESTRO DEPARTAMENTO TÉCNICO MEJORA CONTINUAMENTE

TU SATISFACCIÓN ES NUESTRO COMPROMISO

Garantizamos la calidad de todos los equipos que fabricamos y distribuimos mediante la realización de pruebas de producto y la emisión de certificados. Fabricamos piezas especiales bajo pedido, adaptándonos a las necesidades específicas de cada cliente.

SERVICIOS TÉCNICOS DE ALTA CALIDAD

Nuestro equipo altamente cualificado es capaz de asesorarle en conducciones y componentes hidráulicos, así como en kits de primeros equipos. Actualizamos y verificamos constantemente nuestra página web y fichas técnicas de todos nuestros productos.

DISEÑO CON IMPRESIÓN 3D

Utilizamos tecnología de fabricación aditiva para mejorar y rediseñar productos. Este sistema permite la comprobación total de los productos sin necesidad de fabricar prototipos y pre series, lo que garantiza un uso más efectivo de materias primas.

SOLUCIONES ADAPTADAS

Diseñamos grupos hidráulicos y buscamos soluciones de aprovisionamiento. Para ello, estudiamos de forma individualizada cada caso, evaluamos y comprobamos los posibles diseños y se adapta a las especificaciones técnicas concretas de cada cliente.

TECHNICAL DEPARTMENT ONGOING IMPROVEMENT

YOUR SATISFACTION IS OUR COMMITMENT

We guarantee the quality of all equipments that we manufacture and distribute, through product tests and issuance of certificates. We manufacture special products upon request.

HIGH QUALITY TECHNICAL CONSULTING SERVICES

Our high qualified team can provide advice on hydraulic and pneumatic connectors, they also offer technical support for Original Equipment Manufacturer. We constantly maintain and update our website and technical data.

3D PRINTING DESIGN

Dicsa implements additive manufacturing technology, using 3D printer to redesign and improve products. This working method ensures more efficient use of raw materials, so it allows checking products without the need for manufacturing massively with prolonged and costly processes.

CUSTOMISED SOLUTIONS

We design and manufacture customised Hydraulic power packs, responding to your specific needs and offering you adapted solutions. DICSA Hydraulic Department studies and evaluates each case in an individualized way and they will adapt designs to technical specifications of each customer.

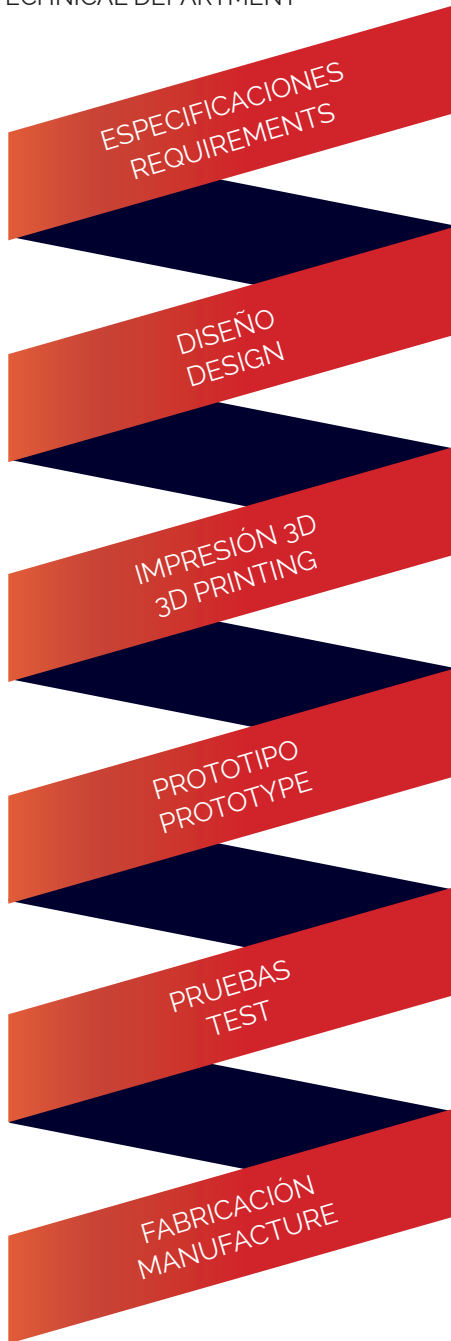

TODO COMIENZA CON UNA IDEA

ÁREA TÉCNICA

SCH TRΔLE RIGID PIPE | **149**

Tubo TrΔle SCH
Rohr SCH
Tube rigide TrΔle SCH

SCH BUTT WELD FITTINGS | **150**

Racores SCH - BUTT WELD
SCH - BW Armaturen
Raccords SCH - BUTT WELD

SOCKET WELD FITTINGS | **152**

Racores SOCKET WELD
SOCKET WELD
Raccords SOCKET WELD

SAE FLANGES | **160**

Bridas SAE
SAE-Flansche
Brides SAE

TRΔLE® CLAMPS | **162**

Abrazaderas TrΔle
Schellen
Colliers TrΔle

03

SCH TRALE® RIGID PIPE / SCH FITTINGS / SAE FLANGES / CLAMPS

Tubo rígido TrAle® SCH / Racores SCH /
Bridas SAE / Abrazaderas

Rohr SCH / SCH Armaturen / SAE-
Flansche / Schellen

Tube rigide SCH TrAle / Embouts SCH /
Brides SAE / Colliers

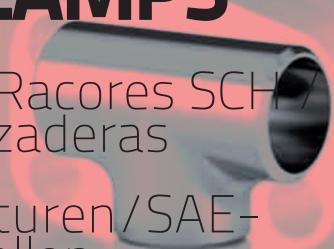
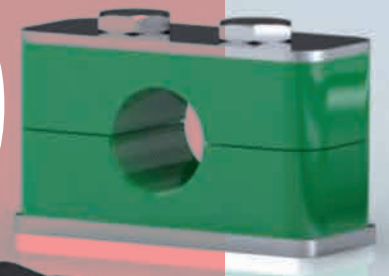

SCH TRALE® RIGID PIPE

Tubo TrΔle SCH
Rohr SCH
Tube rigide TrΔle SCH

Schedule 10 ▪ Tubo SCH10 ▪ Schedule 10 ▪ Schedule 10

| 149



ZTH10

ZTH10...-3

Schedule 40 ▪ Tubo SCH40 ▪ Schedule 40 ▪ Schedule 40

| 149



ZTH40

ZTH40...-3

SCH BUTT WELD FITTINGS

Racores SCH - BUTT WELD

SCH - BW Armaturen

Raccords SCH - BUTT WELD

SCH -BW Pipe Fittings ▪ Racores Tubo SCH - BW ▪ SCH - BW Rohrverbindungsstücke ▪ Raccords SCH - BW

150



ZS9010



ZST100



ZSR100



ZSC100



ZS9040



ZST400



ZSR400



ZSC400

SOCKET WELD FITTINGS

Racores SOCKET WELD
SOCKET WELD
Raccords SOCKET WELD

SOCKET WELD 3000 fittings ▪ Racores SOCKET WELD 3000 ▪ BUCHSENSCHWEISSEN 3000 Armaturen ▪ Raccords SOCKET WELD 3000

152



ZSW390



ZSW3C



ZSW3T



ZSW3CR



ZSW3M

SOCKET WELD 6000 fittings ▪ Racores SOCKET WELD 6000 ▪ BUCHSENSCHWEISSEN 6000 Armaturen ▪ Raccords SOCKET WELD 6000

152



ZSW690



ZSW6M

SAE FLANGES

Bridas SAE
SAE-Flansche
Brides SAE

154



ZBBP

ZBBE

ZBCE

Threaded flanges ▪ Bridas roscadas ▪ Gewindeflansche - GF ▪ Brides taraudées

155



ZBBRG

ZBCRG

ZB90RG

Welding flanges for gas tube ▪ Bridas soldables tubo Gas ▪ Schweißflansche Rohr Gas ▪ Brides à souder pour tube gaz

156



ZBBSG

ZBCSG

ZB90SG

Welding flanges for metric tube ▪ Bridas soldables tubo Métrico ▪ Schweißflansche Rohr metr. ▪ Brides à souder pour tube métrique

157



ZBBSM

ZBCSM

ZB90SM

Blind flanges ▪ Bridas ciegas ▪ Blindflansche ▪ Brides avec obturateur fermé

158



ZBBC

ZBCC

Welding adaptors for flanges ▪ Conos soldar ▪ Schweißkegel ▪ Collets à souder

159



ZBSM*1

ZBSG*1

ZBSM*0

ZBSG*0

ZBSW

Flange accessories ▪ Accesorios bridas ▪ Zubehör für Flansche ▪ Accessoires pour brides

160



ZTB

JBR

JUNTAS

TRALE® CLAMPS

Abrazaderas TrΔle
Schellen
Colliers TrΔle

Complete clamps light serie ▪ Abrazaderas completas serie ligera ▪ Befestigungsschellen komplett - Leichte Serie ▪ Colliers complets série légère

161

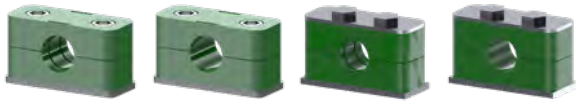

ZA40AZ

ZA40AZPL

ZA41AZ

ZA41AZPL



A..C

ZAPIN

ZAPS

ZAVTC

ZAVTE

ZAPA

ZAPT

162

Double clamp - parallel ▪ Dobles / paralelas ▪ Doppel - Parallel ▪ Colliers de fixation doubles

164



ZAZCFS

ZADPIN

ZADPS

AD..C

ZADVTE

Clamps heavy serie ▪ Abrazaderas serie pesada ▪ Rohrschellen Schwere Serie ▪ Colliers série lourde

165



ZAZCPS

AMPP C

ZAPINP

ZAPSP

ZAVTE

TC/TS

SCH TRALE® RIGID PIPE

Tubo TrΔle SCH
Rohr SCH
Tube rigide TrΔle SCH

SCH 10 rigid pipe - 6 metres- AISI 316

Tubo rígido SCH10 - AISI 316 - 6 METROS

Rohr - SCH10 - 6 Meter- AISI 316

Tube rigide SCH10 - 6 metres- AISI 316



DN	Ø EXT. Ø OUTER	Espesor (mm) Thickness (mm)	Referencia Part n°	€/M
1/2"	21.3	2.11	ZTH10SC008	37,15
3/4"	26.7	2.11	ZTH10SC012	50,04
1"	33.4	2.77	ZTH10SC016	78,82
1" 1/4	42.2	2.77	ZTH10SC020	100,22
1" 1/2	48.3	2.77	ZTH10SC024	115,42
2"	60.3	2.77	ZTH10SC032	181,31

SCH 10 rigid pipe - 3 meters - AISI 316

Tubo rígido SCH10 - AISI 316 - 3 METROS

Rohr - SCH10 - 3 Meter- AISI 316

Tube rigide SCH10 - 3 metres - AISI 316



DN	Ø EXT. Ø OUTER	Espesor (mm) Thickness (mm)	Referencia Part n°	€/M
1/2"	21.3	2.11	ZTH10SC008-3	39,79
3/4"	26.7	2.11	ZTH10SC012-3	52,54
1"	33.4	2.77	ZTH10SC016-3	82,76
1" 1/4	42.2	2.77	ZTH10SC020-3	105,23
1" 1/2	48.3	2.77	ZTH10SC024-3	121,20
2"	60.3	2.77	ZTH10SC032-3	190,37

SCH 40 rigid pipe - 6 meters - AISI 316

Tubo rígido SCH40 - AISI 316 - 6 METROS

Rohr - SCH40 - 6 Meter- AISI 316

Tube rigide SCH40 - 6 metres - AISI 316



DN	Ø EXT. Ø OUTER	Espesor (mm) Thickness (mm)	Referencia Part n°	€/M
1/2"	21.3	2.77	ZTH40SC008	45,43
3/4"	26.7	2.87	ZTH40SC012	59,10
1"	33.4	3.38	ZTH40SC016	79,71
1" 1/4	42.2	3.56	ZTH40SC020	105,03
1" 1/2	48.3	3.68	ZTH40SC024	128,25
2"	60.3	3.91	ZTH40SC032	156,98

SCH 40 rigid pipe - 3 metres- AISI 316

Tubo rígido SCH40 - AISI 316 - 3 METROS

Rohr - SCH40 - 3 Meter- AISI 316

Tube rigide SCH40 - 3 metres- AISI 316



DN	Ø EXT. Ø OUTER	Espesor (mm) Thickness (mm)	Referencia Part n°	€/M
1/2"	21.3	2.77	ZTH40SC008-3	47,70
3/4"	26.7	2.87	ZTH40SC012-3	62,05
1"	33.4	3.38	ZTH40SC016-3	83,70
1" 1/4	42.2	3.56	ZTH40SC020-3	110,28
1" 1/2	48.3	3.68	ZTH40SC024-3	134,66
2"	60.3	3.91	ZTH40SC032-3	164,83



AMPLIA GAMA TUBO RÍGIDO

SCHEDULE MÉTRICO STANDARD CROMO III



INOXIDABLE
STAINLESS-STEEL

CARBONO
CARBON-STEEL

SELECT YOUR
PIPE TYPE

SCH BUTT WELD FITTINGS

Racores SCH - BUTT WELD

SCH - BW Armaturen

Raccords SCH - BUTT WELD

Elbow 90 Sch10

NEW

Codo 90 SCH10

Edelstahlbogen 90 Sch10

Coude 90 Sch10



DN	Referencia Part n°	€
1/2"	ZS9010008	5,41
3/4"	ZS9010012	6,32
1"	ZS9010016	7,22
1" 1/4	ZS9010020	12,51
1" 1/2	ZS9010024	14,44
2"	ZS9010032	19,85

Tee Sch10

NEW

Te SCH10

Tee Edelstahl Sch10

Té Sch10



DN	Referencia Part n°	€
1/2"	ZST10008	13,48
3/4"	ZST10012	16,70
1"	ZST10016	25,52
1" 1/4	ZST10020	33,08
1" 1/2	ZST10024	38,79
2"	ZST10032	54,43

Reduction Sch10

NEW

Reducción SCH10

Reduzierung Sch10 Edelstahl

Réduction Sch10



DN	Referencia Part n°	€
3/4" - 1/2"	ZSR10012008	6,56
1" - 3/4"	ZSR10016012	7,22
1" 1/4 - 1"	ZSR10020016	9,62
1" 1/2 - 1" 1/4	ZSR10024020	10,83
2" - 1" 1/2	ZSR10032024	16,54

Cap Sch10

NEW

Tapón SCH10

Verschluss Sch10 Edelstahl

Bouchon Sch 10



DN	Referencia Part n°	€
1/2"	ZSC10008	7,22
3/4"	ZSC10012	9,02
1"	ZSC10016	10,83
1" 1/4	ZSC10020	11,43
1" 1/2	ZSC10024	12,63
2"	ZSC10032	15,04

SCH BUTT WELD FITTINGS

Racores SCH - BUTT WELD

SCH - BW Armaturen

Raccords SCH - BUTT WELD

CRIMPING FITTINGS
FOR HOSES

PIPE
FITTINGS

PIPE
FITTINGS II

ADAPTORS

WELDING
FITTINGS

INDUSTRIAL
FITTINGS

ACCESSORIES

CONTROL
COMPONENTS

FLOW
MEASURING

TRALE LOK®

Elbow 90 Sch40

Codo 90 SCH40

Edelstahlbogen 90 Sch40

Coude 90 Sch40



DN	Referencia Part n°	€
1/2"	ZS9040008	6,75
3/4"	ZS9040012	7,36
1"	ZS9040016	8,28
1" 1/4	ZS9040020	14,73
1" 1/2	ZS9040024	17,18
2"	ZS9040032	28,53

Tee Sch40

Te Inox SCH40

Tee Edelstahl Sch40

Té Sch40



DN	Referencia Part n°	€
1/2"	ZST40008	19,34
3/4"	ZST40012	21,10
1"	ZST40016	28,98
1" 1/4	ZST40020	38,30
1" 1/2	ZST40024	48,71
2"	ZST40032	66,59

Reduction Sch40

Reducción Inox SCH40

Reduzierung Sch40 Edelstahl

Réduction Sch40



DN	Referencia Part n°	€
3/4" - 1/2"	ZSR40012008	7,22
1" - 3/4"	ZSR40016012	8,72
1" 1/4 - 1"	ZSR40020016	12,33
1" 1/2 - 1" 1/4	ZSR40024020	15,64
2" - 1" 1/2"	ZSR40032024	21,66

Cap Sch40

Tapón Inox SCH40

Verschluss Sch40 Edelstahl

Bouchon Sch40



DN	Referencia Part n°	€
1/2"	ZSC40008	8,72
3/4"	ZSC40012	10,23
1"	ZSC40016	13,53
1" 1/4	ZSC40020	14,14
1" 1/2	ZSC40024	15,04
2"	ZSC40032	17,14

SOCKET WELD FITTINGS

Racores SOCKET WELD

SOCKET WELD

Raccords SOCKET WELD

SOCKET WELD 3000 fittings Elbow 90

NEW

Racores SOCKET WELD 3000 Codo 90

BUCHSENSCHWEISSEN 3000 Armaturen Winkel 90

Raccords SOCKET WELD 3000 Coude 90



DN	Referencia Part n°	€
1/2"	ZSW39008	13,53
3/4"	ZSW39012	18,05
1"	ZSW39016	26,17
1" 1/4	ZSW39020	42,71
1" 1/2	ZSW39024	61,66
2"	ZSW39032	101,96

SOCKET WELD 3000 Couplings Fittings

NEW

Racores SOCKET WELD 3000 Manguito

BUCHSENSCHWEISSEN 3000 kupplungen
Armaturen

SOCKET WELD 3000 Accouplements Raccords



DN	Referencia Part n°	€
1/2"	ZSW3M08	6,02
3/4"	ZSW3M12	9,02
1"	ZSW3M16	14,44
1" 1/4	ZSW3M20	19,25
1" 1/2	ZSW3M24	25,57
2"	ZSW3M32	48,72

SOCKET WELD 3000 Cap Fittings

NEW

Racores SOCKET WELD 3000 Cap

BUCHSENSCHWEISSEN 3000 Kappenanschlüsse

Raccords à chapeau SOCKET WELD 3000



DN	Referencia Part n°	€
1/2"	ZSW3C08	5,20
3/4"	ZSW3C12	6,85
1"	ZSW3C16	11,23
1" 1/4	ZSW3C20	15,07
1" 1/2	ZSW3C24	19,17
2"	ZSW3C32	32,60

SOCKET WELD 6000 fittings Elbow 90

NEW

Racores SOCKET WELD 6000 Codo 90

BUCHSENSCHWEISSEN 6000 Armaturen Winkel 90

Raccords SOCKET WELD 6000 Coude 90



DN	Referencia Part n°	€
1/2"	ZSW69008	15,61
3/4"	ZSW69012	22,19
1"	ZSW69016	40,27
1" 1/4	ZSW69020	49,03

SOCKET WELD 3000 Tee fittings

NEW

Racores SOCKET WEL 3000 Te

BUCHSENSCHWEISSEN 3000 T-Stücke

Raccords en T SOCKET WELD 3000



DN	Referencia Part n°	€
1/2"	ZSW3T08	19,25
3/4"	ZSW3T12	26,17
1"	ZSW3T16	41,20
1" 1/4	ZSW3T20	62,25
1" 1/2	ZSW3T24	78,20
2"	ZSW3T32	148,58

SOCKET WELD 6000 Couplings FittingsFittings

NEW

Racores SOCKET WELD 6000 Manguito

BUCHSENSCHWEISSEN 6000 kupplungen
Armaturen

SOCKET WELD 6000 Accouplements Raccords



DN	Referencia Part n°	€
1/2"	ZSW6M08	8,49
3/4"	ZSW6M12	12,60
1"	ZSW6M16	19,17
1" 1/4	ZSW6M20	24,38

SOCKET WELD 3000 Cross Fittings

NEW

Racores SOCKET WELD 3000 Cruz

BUCHSENSCHWEISSEN 3000 Kreuzstück

Raccords croix SOCKET WELD 3000



DN	Referencia Part n°	€
1/2"	ZSW3CR08	*
3/4"	ZSW3CR12	*
1"	ZSW3CR16	*
1" 1/4	ZSW3CR20	*
1" 1/2	ZSW3CR24	*
2"	ZSW3CR32	*

SAE FLANGES

Bridas SAE
SAE-Flansche
Brides SAE

■ **Common characteristics**
Características comunes
Allgemeine Eigenschaften
Données communes

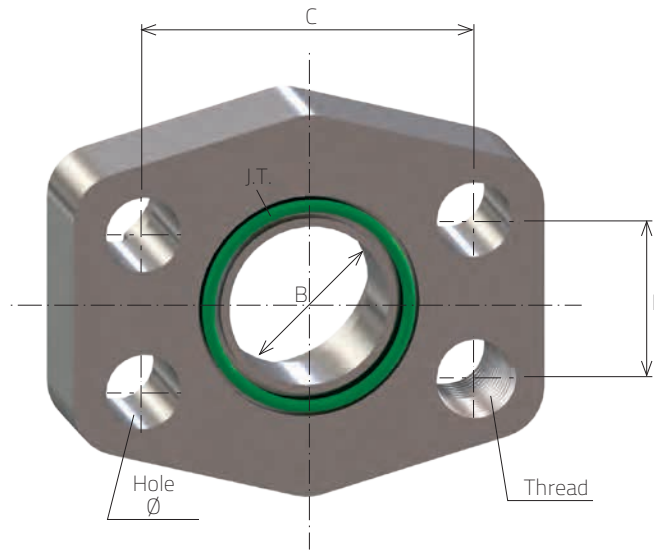

■ **Flanges 3000 PSI**
Bridas 3000 PSI
Flansche 3000 PSI
Brides 3000 PSI

Size	Max. pre.	B	C	E	O'ring NBR	PU seal	Ø	Screw *	Thread
1/2"	345 bar	13	38,1	17,48	18,64 x 3,53	JBR08	9	TB8X30	M8
3/4"	345 bar	19	47,63	22,23	24,99 x 3,53	JBR12	11	TB10X35	M10
1"	345 bar	25	52,37	26,19	32,92 x 3,53	JBR16	11	TB10X35	M10
1 1/4"	276 bar	32	58,72	30,18	37,70 x 3,53	JBR20	11,5	TB10X40	M10
1 1/2"	207 bar	38	69,85	35,71	47,22 x 3,53	JBR24	13,5	TB12X45	M12
2"	207 bar	51	77,77	42,88	56,74 x 3,53	JBR32	13,5	TB12X45	M12
2 1/2"	172 bar	63	88,9	50,8	66,27 x 3,53		13,5	TB12X45	M12
3"	138 bar	73	106,38	61,93	85,32 x 3,53		17,5	TB16X50	M16
3 1/2"	34 bar	89	120,65	69,85	98,02 x 3,53		17,5	TB16X50	M16
4"	34 bar	99	130,18	77,77	110,72 x 3,53		17,5	TB16X50	M16

■ **Flanges 6000 PSI**
Bridas 6000 PSI
Flansche 6000 PSI
Brides 6000 PSI

Size	Max. pre.	B	C	E	O'ring NBR	PU seal	Ø	Screw *	Thread
1/2"	414 bar	13	40,49	18,24	18,64 x 3,53	JBR08	9	TB8X30	M8
3/4"	414 bar	19	50,8	23,8	24,99 x 3,53	JBR12	11	TB10X40	M10
1"	414 bar	25	57,15	27,76	32,92 x 3,53	JBR16	13	TB12X45	M12
1 1/4"	414 bar	32	66,68	31,75	37,70 x 3,53	JBR20	15	TB14X45	M14
1 1/2"	414 bar	38	79,38	36,5	47,22 x 3,53	JBR24	17	TB16X50	M16
2"	414 bar	51	98,82	44,45	56,74 x 3,53	JBR32	21	TB20X70	M20

* **Screws are in carbon steel. For Stainless Steel screws, ask for ZTB... part number.**
Tornillos en acero carbono. Para tornillos en acero inoxidable, pedir ZTB...
Die Schrauben sind aus Karbonstahl. Für Edelstahl fragen Sie bitten nach ZTB... Artikelnummern.
Les vis sont en acier carbone. Pour vis en acier inoxydable, veuillez demander les références ZTB ...

SAE FLANGES

Bridas SAE
SAE-Flansche
Brides SAE

SAE Split flange

Brida partida pasante

Durchgehender Halbflansch

Demi-bride de fixation



SERIE SERIES	Ø INT. Ø INNER	TAMAÑO SIZE	Referencia Part n°	€
3000 PSI	30.2	1/2"	ZBBP308302	*
3000 PSI	38.1	3/4"	ZBBP312381	*
3000 PSI	44.5	1"	ZBBP316445	*
3000 PSI	50.8	1"1/4	ZBBP320508	*
3000 PSI	60.3	1"1/2	ZBBP324603	*
3000 PSI	71.4	2"	ZBBP332714	*
3000 PSI	84.1	2" 1/2	ZBBP340841	*
3000 PSI	102.4	3"	ZBBP3481024	*
3000 PSI	127	4"	ZBBP364127	*
6000 PSI	31.8	1/2"	ZBBP608318	*
6000 PSI	41.3	3/4"	ZBBP612413	*
6000 PSI	47.6	1"	ZBBP616476	*
6000 PSI	54	1"1/4	ZBBP620540	*
6000 PSI	63.5	1"1/2	ZBBP624635	*
6000 PSI	79.4	2"	ZBBP632794	*

*See prices in p.40 / *Ver precios en p.40 / *Vgl. Sie die Preise auf S. 40 / *Prix à la p.40

SAE counter-flange

Contrabrida roscada

Gewindegegenflansch

Contre-bride passage total



SERIE SERIES	Ø INT. Ø INNER	TAMAÑO SIZE	Referencia Part n°	€
3000 PSI	30,2	1/2"	ZBCE308302	*
3000 PSI	38,1	3/4"	ZBCE312381	*
3000 PSI	44,5	1"	ZBCE316445	*
3000 PSI	50,8	1"1/4	ZBCE320508	*
3000 PSI	60,3	1"1/2	ZBCE324603	*
3000 PSI	71,4	2"	ZBCE332714	*
6000 PSI	31,8	1/2"	ZBCE608318	*
6000 PSI	41,3	3/4"	ZBCE612413	*
6000 PSI	47,6	1"	ZBCE616476	*
6000 PSI	54	1"1/4	ZBCE620540	*
6000 PSI	63,5	1"1/2	ZBCE624635	*
6000 PSI	79,4	2"	ZBCE632794	*

SAE Flange

Brida entera pasante

Durchgehender Vollflansch

Bride de fixation monobloc



SERIE SERIES	Ø INT. Ø INNER	TAMAÑO SIZE	Referencia Part n°	€
3000 PSI	30.2	1/2"	ZBBE308302	*
3000 PSI	38.1	3/4"	ZBBE312381	*
3000 PSI	44.5	1"	ZBBE316445	*
3000 PSI	50.8	1"1/4	ZBBE320508	*
3000 PSI	60.3	1"1/2	ZBBE324603	*
3000 PSI	71.4	2"	ZBBE332714	*
3000 PSI	41	2" 1/2	ZBBE340841	*
3000 PSI	102.4	3"	ZBBE3481024	*
3000 PSI	127	4"	ZBBE364127	*
6000 PSI	31.8	1/2"	ZBBE608318	*
6000 PSI	41.3	3/4"	ZBBE612413	*
6000 PSI	47.6	1"	ZBBE616476	*
6000 PSI	54	1"1/4	ZBBE620540	*
6000 PSI	63.5	1"1/2	ZBBE624635	*
6000 PSI	79.4	2"	ZBBE632794	*

*See prices in p.40 / *Ver precios en p.40 / *Vgl. Sie die Preise auf S. 40 / *Prix à la p.40

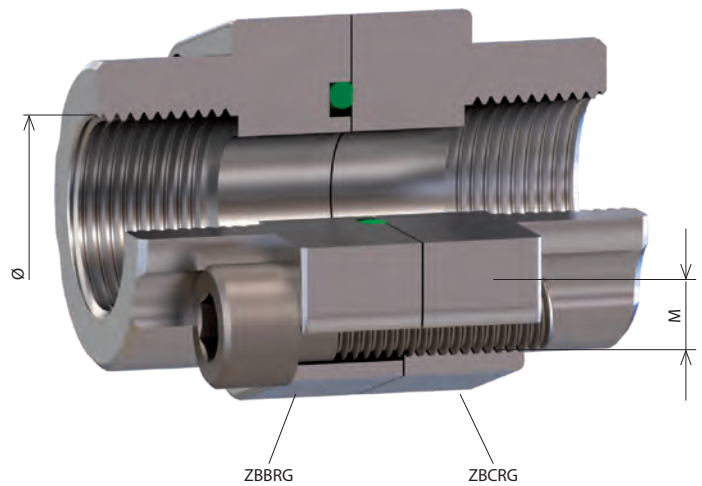

*On request / Consultar / Auf Anfrage / Sur demande

SAE FLANGES

Bridas SAE
SAE-Flansche
Brides SAE

BSP Female threaded flange

Brida roscada hembra BSP

Gewindeflansch w BSP

Bride taraudée femelle BSP



SERIE SERIES	ROSCA THREAD	TAMAÑO SIZE	Referencia Part n°	€
3000 PSI	1/2" BSP	1/2"	ZBBRG30808	28,08
3000 PSI	3/4" BSP	3/4"	ZBBRG31212	37,47
3000 PSI	1" BSP	1"	ZBBRG31616	46,79
3000 PSI	1"1/4 BSP	1"1/4	ZBBRG32020	59,20
3000 PSI	1"1/2 BSP	1"1/2	ZBBRG32424	88,59
3000 PSI	2" BSP	2"	ZBBRG33232	115,17
3000 PSI	2"1/2 BSP	2"1/2	ZBBRG34040	162,42
3000 PSI	3" BSP	3"	ZBBRG34848	200,76
3000 PSI	3"1/2 BSP	3"1/2	ZBBRG35656	817,53
3000 PSI	4" BSP	4"	ZBBRG36464	883,80
6000 PSI	1/2" BSP	1/2"	ZBBRG60808	31,22
6000 PSI	3/4" BSP	3/4"	ZBBRG61212	43,63
6000 PSI	1" BSP	1"	ZBBRG61616	62,36
6000 PSI	1"1/4 BSP	1"1/4	ZBBRG62020	84,18
6000 PSI	1"1/2 BSP	1"1/2	ZBBRG62424	119,20
6000 PSI	2" BSP	2"	ZBBRG63232	213,49

BSP Female threaded counter-flange

Contrabrida roscada hembra BSP

Gewindegegenflansch w BSP

Contre-bride taraudée femelle BSP



SERIE SERIES	ROSCA THREAD	TAMAÑO SIZE	Referencia Part n°	€
3000 PSI	1/2" BSP	1/2"	ZBCRG30808	29,64
3000 PSI	3/4" BSP	3/4"	ZBCRG31212	37,47
3000 PSI	1" BSP	1"	ZBCRG31616	46,79
3000 PSI	1"1/4 BSP	1"1/4	ZBCRG32020	59,20
3000 PSI	1"1/2 BSP	1"1/2	ZBCRG32424	93,51
3000 PSI	2" BSP	2"	ZBCRG33232	115,17
3000 PSI	2"1/2 BSP	2"1/2	ZBCRG34040	162,42
3000 PSI	3" BSP	3"	ZBCRG34848	211,91
3000 PSI	3"1/2 BSP	3"1/2	ZBCRG35656	817,53
3000 PSI	4" BSP	4"	ZBCRG36464	883,80
6000 PSI	1/2" BSP	1/2"	ZBCRG60808	31,22
6000 PSI	3/4" BSP	3/4"	ZBCRG61212	43,63
6000 PSI	1" BSP	1"	ZBCRG61616	62,36
6000 PSI	1"1/4 BSP	1"1/4	ZBCRG62020	84,18
6000 PSI	1"1/2 BSP	1"1/2	ZBCRG62424	119,20
6000 PSI	2" BSP	2"	ZBCRG63232	213,49

90° BSP female threaded flange

Brida codo 90° roscada hembra BSP

Gewindeflansch Winkel 90° w BSP

Bride 90° taraudée femelle BSP



SERIE SERIES	ROSCA THREAD	TAMAÑO SIZE	Referencia Part n°	€
3000 PSI	1/2" BSP	1/2"	ZB90RG30808	160,83
3000 PSI	3/4" BSP	3/4"	ZB90RG31212	192,58
3000 PSI	1" BSP	1"	ZB90RG31616	229,93
3000 PSI	1"1/4 BSP	1"1/4	ZB90RG32020	275,99
3000 PSI	1"1/2 BSP	1"1/2	ZB90RG32424	539,12
3000 PSI	2" BSP	2"	ZB90RG33232	651,66
6000 PSI	1/2" BSP	1/2"	ZB90RG60808	160,83
6000 PSI	3/4" BSP	3/4"	ZB90RG61212	229,93
6000 PSI	1" BSP	1"	ZB90RG61616	275,99
6000 PSI	1"1/4 BSP	1"1/4	ZB90RG62020	377,27
6000 PSI	1"1/2 BSP	1"1/2	ZB90RG62424	496,40

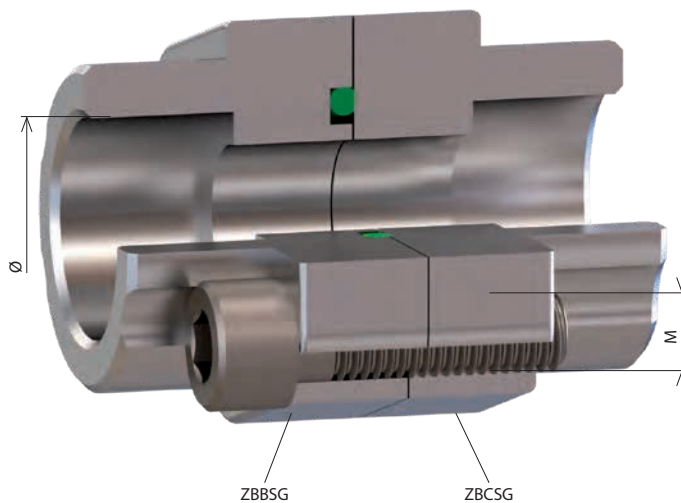

SAE FLANGES

Bridas SAE
SAE-Flansche
Brides SAE

Welding female flange for gas tube

Brida soldable hembra tubo gas

Schweißflansch w Rohr Gas

Bride à souder femelle tube gaz



SERIE SERIES	Ø INT. Ø INNER	TAMAÑO SIZE	Referencia Part n°	€
3000 PSI	21.6	1/2"	ZBBSG308216	29,64
3000 PSI	27.2	3/4"	ZBBSG312272	37,47
3000 PSI	34.0	1"	ZBBSG316340	46,79
3000 PSI	42.8	1 1/4"	ZBBSG320428	59,20
3000 PSI	48.6	1 1/2"	ZBBSG324486	93,51
3000 PSI	61.0	2"	ZBBSG332610	121,57
3000 PSI	76.6	2 1/2"	ZBBSG340766	171,44
3000 PSI	90.5	3"	ZBBSG348905	211,91
3000 PSI	103.0	3 1/2"	ZBBSG3561030	773,34
3000 PSI	115.5	4"	ZBBSG3641155	839,60
6000 PSI	21.6	1/2"	ZBBSG608216	31,22
6000 PSI	27.2	3/4"	ZBBSG612272	43,63
6000 PSI	34.0	1"	ZBBSG616340	62,36
6000 PSI	42.8	1 1/4"	ZBBSG620428	84,18
6000 PSI	48.6	1 1/2"	ZBBSG624486	119,20
6000 PSI	61.0	2"	ZBBSG632610	213,49

90° welding female flange for gas tube

Brida codo 90° soldable hembra tubo gas

Vorschweißflansch Winkel 90° w Rohr Gas

Bride 90° à souder femelle tube gaz



SERIE SERIES	Ø INT. Ø INNER	TAMAÑO SIZE	Referencia Part n°	€
3000 PSI	21.6	1/2"	ZB90SG308216	172,07
3000 PSI	27.2	3/4"	ZB90SG312272	186,64
3000 PSI	34.0	1"	ZB90SG316340	223,18
3000 PSI	42.8	1 1/4"	ZB90SG320428	268,46
3000 PSI	48.6	1 1/2"	ZB90SG324486	369,71
3000 PSI	61.0	2"	ZB90SG332610	486,45
6000 PSI	21.6	1/2"	ZB90SG608216	154,86
6000 PSI	27.2	3/4"	ZB90SG612272	244,34
6000 PSI	34.0	1"	ZB90SG616340	268,46
6000 PSI	42.8	1 1/4"	ZB90SG620428	369,71
6000 PSI	48.6	1 1/2"	ZB90SG624486	486,45

Welding female counter-flange for gas tube

Contrabrida soldable hembra tubo gas

Schweiß-Gegenflansch w Rohr Gas

Contre-bride à souder femelle tube gaz



SERIE SERIES	Ø INT. Ø INNER	TAMAÑO SIZE	Referencia Part n°	€
3000 PSI	21.6	1/2"	ZBCSG308216	29,64
3000 PSI	27.2	3/4"	ZBCSG312272	37,47
3000 PSI	34.0	1"	ZBCSG316340	46,79
3000 PSI	42.8	1 1/4"	ZBCSG320428	59,20
3000 PSI	48.6	1 1/2"	ZBCSG324486	93,51
3000 PSI	61.0	2"	ZBCSG332610	121,57
3000 PSI	76.6	2 1/2"	ZBCSG340766	171,44
3000 PSI	90.5	3"	ZBCSG348905	211,91
3000 PSI	103.0	3 1/2"	ZBCSG3561030	773,34
3000 PSI	115.5	4"	ZBCSG3641155	839,60
6000 PSI	21.6	1/2"	ZBCSG608216	31,22
6000 PSI	27.2	3/4"	ZBCSG612272	43,63
6000 PSI	34.0	1"	ZBCSG616340	62,36
6000 PSI	42.8	1 1/4"	ZBCSG620428	84,18
6000 PSI	48.6	1 1/2"	ZBCSG624486	119,20
6000 PSI	61.0	2"	ZBCSG632610	213,49

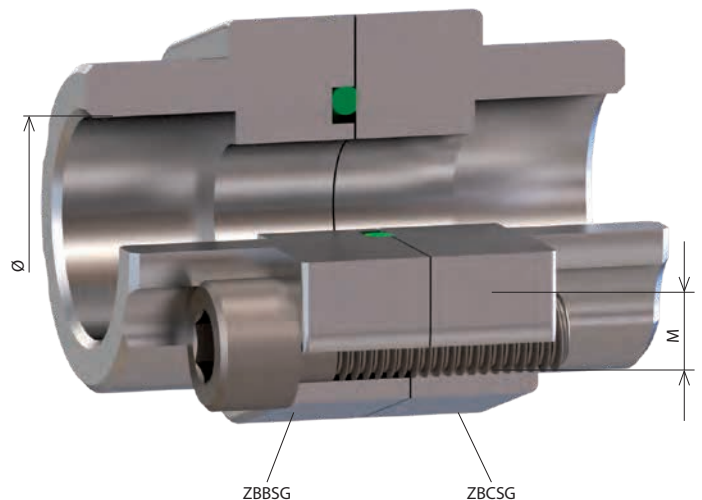

SAE FLANGES

Bridas SAE
SAE-Flansche
Brides SAE

Female welding flange for metric tube

Brida soldable hembra tubo métrico

Schweißflansch w Rohr metr.

Bride à souder femelle tube métrique



SERIE SERIES	Ø INT. Ø INNER	TAMAÑO SIZE	Referencia Part n°	€
3000 PSI	20.3	1/2"	ZBBSM308203	29,64
3000 PSI	25.3	3/4"	ZBBSM312253	37,47
3000 PSI	30.3	1"	ZBBSM316303	46,79
3000 PSI	38.3	1"1/4	ZBBSM320383	59,20
3000 PSI	50.5	1"1/2	ZBBSM324505	93,51
6000 PSI	20.3	1/2"	ZBBSM608203	31,22
6000 PSI	25.3	3/4"	ZBBSM612253	43,63
6000 PSI	30.3	1"	ZBBSM616303	62,36
6000 PSI	38.3	1"1/4	ZBBSM620383	84,18
6000 PSI	50.5	1"1/2	ZBBSM624505	119,20

Female welding counter-flange for metric tube

Contrabrida soldable hembra tubo métrico

Schweiß-Gegenflansch w Rohr metr.

Contre-bride à souder femelle tube métrique



SERIE SERIES	Ø INT. Ø INNER	TAMAÑO SIZE	Referencia Part n°	€
3000 PSI	20.3	1/2"	ZBCSM308203	29,64
3000 PSI	25.3	3/4"	ZBCSM312253	37,47
3000 PSI	30.3	1"	ZBCSM316303	46,79
3000 PSI	38.3	1"1/4	ZBCSM320383	59,20
3000 PSI	50.5	1"1/2	ZBCSM324505	93,51
6000 PSI	20.3	1/2"	ZBCSM608203	31,22
6000 PSI	25.3	3/4"	ZBCSM612253	43,63
6000 PSI	30.3	1"	ZBCSM616303	62,36
6000 PSI	38.3	1"1/4	ZBCSM620383	84,18
6000 PSI	50.5	1"1/2	ZBCSM624505	119,20

90° female welding flange for metric tube

Brida codo 90° soldable Hembra tubo métrico

Vorschweißflansch Winkel 90° w Rohr metr.

Bride 90° à souder femelle tube métrique



SERIE SERIES	Ø INT. Ø INNER	TAMAÑO SIZE	Referencia Part n°	€
3000 PSI	20.3	1/2"	ZB90SM308203	*
3000 PSI	25.3	3/4"	ZB90SM312253	*
3000 PSI	30.3	1"	ZB90SM316303	*
3000 PSI	38.3	1"1/4	ZB90SM320383	*
3000 PSI	50.5	1"1/2	ZB90SM324505	*
6000 PSI	20.3	1/2"	ZB90SM608203	*
6000 PSI	25.3	3/4"	ZB90SM612253	*
6000 PSI	30.3	1"	ZB90SM616303	*
6000 PSI	38.3	1"1/4	ZB90SM620383	*
6000 PSI	50.5	1"1/2	ZB90SM624505	*

MALE WELDING FLANGES

Bridas soldables macho
Schweißflansche männlich
Brides à souder mâle

- Male welding flange for gas tube
Brida soldable macho tubo gas
Schweißflansch männlich Rohr Gas
Bride à souder mâle tube gaz

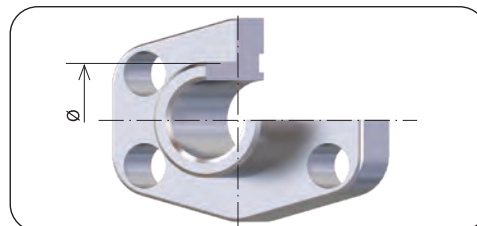

Ref: ZBMSG

- Male welding counterflange for gas tube
Contrabrida macho soldable tubo gas
Gegenschweißflansch männlich Rohr Gas
Contre-bride à souder mâle tube gaz

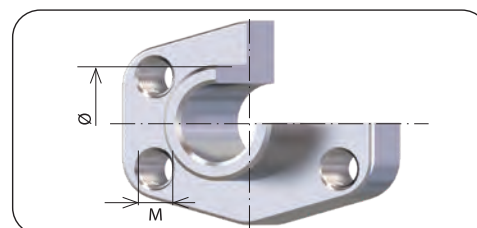

Ref: ZBCMSG

- Male welding flange for metric tube
Brida soldable macho tubo métrico
Metrischer Schweißflansch männlich Rohr
Bride à souder mâle tube métrique

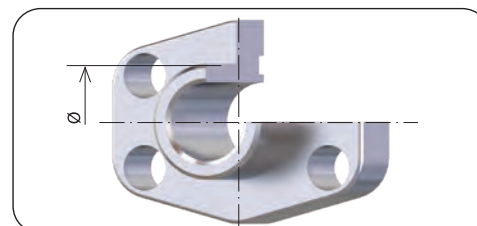

Ref: ZBMSM

- Male welding counterflange for metric tube
Contrabrida macho soldable tubo métrico
Metrischer Gegenschweißflansch männlich Rohr
Contre-bride à souder mâle tube métrique

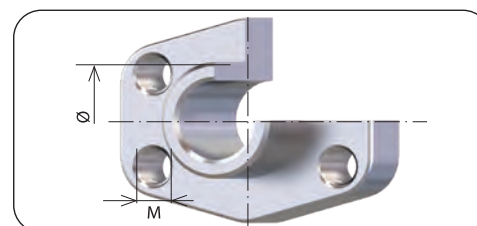

Ref: ZBCMSM

SAE FLANGES

Bridas SAE
SAE-Flansche
Brides SAE

Blind flanges

Bridas ciegas

Blindflansche

Brides avec obturateur fermé



Blind counter-flanges

Contrabridas ciegas

Blind-/Gegenflansche

Contre-brides avec obturateur fermé



SERIE SERIES	TAMAÑO SIZE	Referencia Part n°	€
3000 PSI	1/2"	ZBBC308	96,99
3000 PSI	3/4"	ZBBC312	118,69
3000 PSI	1"	ZBBC316	139,54
3000 PSI	1"1/4	ZBBC320	162,80
3000 PSI	1"1/2	ZBBC324	209,32
3000 PSI	2"	ZBBC332	241,89
3000 PSI	2"1/2	ZBBC340	279,11
3000 PSI	3"	ZBBC348	395,39
3000 PSI	3"1/2	ZBBC356	511,70
3000 PSI	4"	ZBBC364	604,68
6000 PSI	1/2"	ZBBC608	103,85
6000 PSI	3/4"	ZBBC612	139,54
6000 PSI	1"	ZBBC616	176,79
6000 PSI	1"1/4	ZBBC620	251,20
6000 PSI	1"1/2	ZBBC624	346,19
6000 PSI	2"	ZBBC632	509,10

SERIE SERIES	TAMAÑO SIZE	Referencia Part n°	€
3000 PSI	1/2"	ZBCC308	102,11
3000 PSI	3/4"	ZBCC312	124,94
3000 PSI	1"	ZBCC316	153,50
3000 PSI	1"1/4	ZBCC320	179,07
3000 PSI	1"1/2	ZBCC324	230,24
3000 PSI	2"	ZBCC332	266,08
3000 PSI	3"	ZBCC348	434,95
3000 PSI	3"1/2	ZBCC356	562,88
3000 PSI	4"	ZBCC364	665,16
6000 PSI	1/2"	ZBCC608	126,13
6000 PSI	3/4"	ZBCC612	153,50
6000 PSI	1"	ZBCC616	194,44
6000 PSI	1"1/4	ZBCC620	241,93
6000 PSI	1"1/2	ZBCC624	434,95
6000 PSI	2"	ZBCC632	639,59

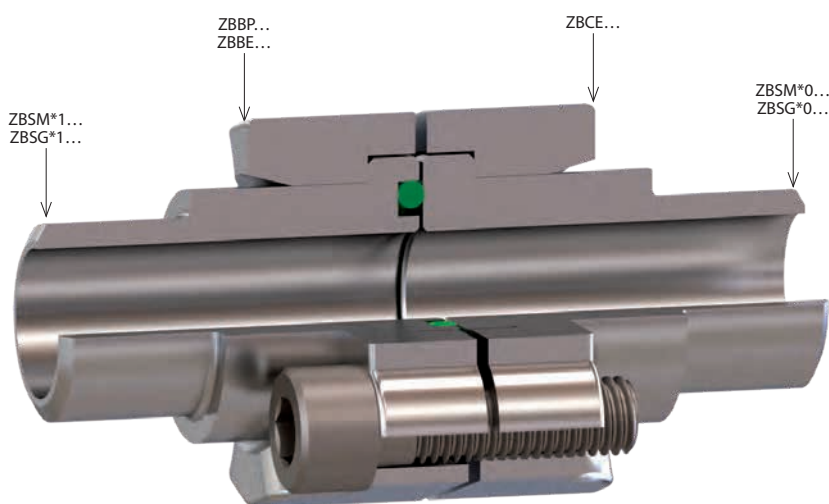

SAE FLANGES

Bridas SAE
SAE-Flansche
Brides SAE

Flange welding adaptor for metric tube

Brida cono soldable tubo métrico

Vorschweißflansch kon. Rohr metr.

Bride collet à souder tube métrique



SERIE SERIES	Ø EXT. Ø OUTER	TAMAÑO SIZE	Referencia Part n°	€
3000 PSI	16	1/2"	ZBSM3108016	88,40
3000 PSI	25	3/4"	ZBSM3112025	106,08
3000 PSI	30	1"	ZBSM3116030	132,56
3000 PSI	38	1 1/4"	ZBSM3120038	159,08
3000 PSI	45	1 1/2"	ZBSM3124045	220,96
3000 PSI	60	2"	ZBSM3132060	265,16
3000 PSI	70	2 1/2"	ZBSM3140070	353,52
3000 PSI	80	3"	ZBSM3148080	618,64
3000 PSI	100	3 1/2"	ZBSM3156100	883,80
3000 PSI	114.3	4"	ZBSM3164114	1.060,56
6000 PSI	16	1/2"	ZBSM6108016	88,40
6000 PSI	25	3/4"	ZBSM6112025	132,56
6000 PSI	30	1"	ZBSM6116030	145,82
6000 PSI	38	1 1/4"	ZBSM6120038	156,44
6000 PSI	45	1 1/2"	ZBSM6124045	243,02
6000 PSI	60	2"	ZBSM6132060	291,64

Counter-flange welding adaptor for metric tube

Contrabrida cono soldable tubo métrico

Schweiß-Gegenflansch kon. Rohr metr.

Contre-bride collet à souder tube métrique



SERIE SERIES	Ø EXT. Ø OUTER	TAMAÑO SIZE	Referencia Part n°	€
3000 PSI	16	1/2"	ZBSM3008016	81,47
3000 PSI	25	3/4"	ZBSM3012025	97,76
3000 PSI	30	1"	ZBSM3016030	122,17
3000 PSI	38	1 1/4"	ZBSM3020038	159,08
3000 PSI	45	1 1/2"	ZBSM3024045	203,64
3000 PSI	60	2"	ZBSM3032060	244,38
3000 PSI	70	2 1/2"	ZBSM3040070	325,81
3000 PSI	80	3"	ZBSM3048080	570,19
3000 PSI	100	3 1/2"	ZBSM3056100	814,57
3000 PSI	114.3	4"	ZBSM3064114	977,48
6000 PSI	16	1/2"	ZBSM6008016	81,47
6000 PSI	25	3/4"	ZBSM6012025	122,17
6000 PSI	30	1"	ZBSM6016030	134,41
6000 PSI	38	1 1/4"	ZBSM6020038	156,44
6000 PSI	45	1 1/2"	ZBSM6024045	224,00
6000 PSI	60	2"	ZBSM6032060	268,79

Flange welding adaptor for gas tube

Brida cono soldable tubo gas

Vorschweißflansch kon. Rohr Gas

Bride collet à souder tube gaz



SERIE SERIES	Ø INT. Ø INNER	TAMAÑO SIZE	Referencia Part n°	€
3000 PSI	21.5	1/2"	ZBSG3108215	81,47
3000 PSI	28.0	3/4"	ZBSG3112280	97,76
3000 PSI	34.0	1"	ZBSG3116340	122,17
3000 PSI	42.8	1 1/4"	ZBSG3120428	159,08
3000 PSI	48.6	1 1/2"	ZBSG3124486	203,64
3000 PSI	61.0	2"	ZBSG3132610	244,38
6000 PSI	21.5	1/2"	ZBSG6108215	81,47
6000 PSI	28.0	3/4"	ZBSG6112280	122,17
6000 PSI	34.0	1"	ZBSG6116340	134,41
6000 PSI	42.8	1 1/4"	ZBSG6120428	156,44
6000 PSI	48.6	1 1/2"	ZBSG6124486	224,00
6000 PSI	61.0	2"	ZBSG6132610	268,79

Counter-flange welding adaptor for gas tube

Contrabrida cono soldable tubo gas

Schweiß-Gegenflansch kon. Rohr Gas

Contre-bride collet à souder tube gaz



SERIE SERIES	Ø INT. Ø INNER	TAMAÑO SIZE	Referencia Part n°	€
3000 PSI	21.5	1/2"	ZBSG3008215	122,27
3000 PSI	28.0	3/4"	ZBSG3012280	97,76
3000 PSI	34.0	1"	ZBSG3016340	122,17
3000 PSI	42.8	1 1/4"	ZBSG3020428	146,63
3000 PSI	48.6	1 1/2"	ZBSG3024486	203,64
3000 PSI	61.0	2"	ZBSG3032610	244,38
6000 PSI	21.5	1/2"	ZBSG6008215	81,47
6000 PSI	28.0	3/4"	ZBSG6012280	122,17
6000 PSI	34.0	1"	ZBSG6016340	134,41
6000 PSI	42.8	1 1/4"	ZBSG6020428	156,44
6000 PSI	48.6	1 1/2"	ZBSG6024486	224,00
6000 PSI	61.0	2"	ZBSG6032610	268,79

Welding flange head SW metric tube

Cabeza brida soldable SW tubo métrico

Schweißflanschkopf SW metrisches Rohr

Tête de bride de soudage SW tube métrique



SERIE SERIES	TUBO PIPE	TAMAÑO SIZE	Referencia Part n°	€
3000 PSI	14	1/2"	ZBSWM3108014	14,42
3000 PSI	22	3/4"	ZBSWM3112022	22,23
3000 PSI	35	1 1/4"	ZBSWM3120035	44,23
3000 PSI	39	1 1/2"	ZBSWM3124039	50,41
3000 PSI	50	2"	ZBSWM3132050	71,40
6000 PSI	22	3/4"	ZBSWM6112022	24,46
6000 PSI	28	1"	ZBSWM6116028	42,72
6000 PSI	35	1 1/4"	ZBSWM6120035	48,64
6000 PSI	39	1 1/2"	ZBSWM6124039	55,46

Until end of stock / Hasta fin de existencias / Bis zum Ende des Lagerbestandes / Jusqu'à la fin du stock

SAE FLANGES

Bridas SAE
SAE-Flansche
Brides SAE

Screws for SAE flanges

Tornillos para bridas SAE

Schrauben für SAE-Flansche

Vis pour brides SAE



ROSCA THREAD	TAMAÑO SIZE	Referencia Part n°	€
M8X30	3000-6000 PSI 1/2"	ZTB8X30	1,43
M10X35	3000 PSI 3/4"-1"	ZTB10X35	2,05
M10X40	3000 PSI 1" 1/4 - 6000 PSI 3/4"	ZTB10X40	2,02
M12X45	3000 PSI 1"1/2-2"-2"1/2-6000 PSI 1"	ZTB12X45	3,84
M14X45	6000 PSI 1"1/4	ZTB14X45	6,52
M16X50	3000 PSI 3"-3"1/2"-4"- 6000 PSI 1" 1/2	ZTB16X50	9,98
M20X70	6000 PSI 2"	ZTB20X70	22,16

Seals for 3000/6000 PSI flange

Juntas para bridas SAE 3000/6000 PSI

Dichtungen 3000/6000 PSI-Flansch

Joints pour bride série 3000/6000



TAMAÑO SIZE	Ø INT. Ø INNER	Ø EXT. Ø OUTER	Referencia Part n°	€
1/2"	17.02	25.40	JBR08	*
3/4"	23.36	31.72	JBR12	*
1"	31.24	39.62	JBR16	*
1"1/4	36.07	44.45	JBR20	*
1"1/2	45.34	53.98	JBR24	*
2"	54.86	63.50	JBR32	*

*See prices in Hydraulic and Pneumatic Connectors' Catalogue / *Ver precios en Conducciones Hidráulicas y Neumáticas / *Vgl. Sie die Preise in der Preisliste Hydraulische und Pneumatische Verbindungen. / *Voir prix dans le Catalogue Connectique Hydraulique et Pneumatique

O-rings for 3000/6000 PSI SAE flanges

Juntas tóricas para bridas SAE 3000/6000 PSI

O-Ringe für 3000/6000 PSI-Flansch

Orings pour bride série 3000/6000 PSI



TAMAÑO SIZE	Ø INT. Ø INNER	Referencia Part n°	€
1/2"	18.64	18.64X3.53	*
3/4"	24.99	24.99X3.53	*
1"	32.92	32.92X3.53	*
1"1/4	37.70	37.70X3.53	*
1"1/2	47.22	47.22X3.53	*
2"	56.74	56.74X3.53	*

*See prices in Hydraulic and Pneumatic Connectors' Catalogue / *Ver precios en Conducciones Hidráulicas y Neumáticas / *Vgl. Sie die Preise in der Preisliste Hydraulische und Pneumatische Verbindungen. / *Voir prix dans le Catalogue Connectique Hydraulique et Pneumatique

TRALE® CLAMPS

Abrazaderas TrAle
Schellen
Colliers TrAle

Light serie simple clamp

Abrazadera ligera simple completa

Einfache Befestigungsschelle komplett - Leichte Serie

Collier de fixation simple complet, série légère

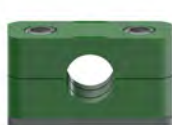

DN	GRUPO GROUP	Referencia Part n°	€
6	1	ZA40AZ06	12,11
8	1	ZA40AZ08	12,11
10	1	ZA40AZ10	12,11
12	1	ZA40AZ12	12,11
14	2	ZA40AZ14	12,78
15	2	ZA40AZ15	12,78
16	2	ZA40AZ16	12,78
18	2	ZA40AZ18	12,78
20	3	ZA40AZ20	13,66
22	3	ZA40AZ22	13,66
23	3	ZA40AZ23	13,66
25	3	ZA40AZ25	13,66
28	4	ZA40AZ28	15,08
30	4	ZA40AZ30	15,08
38	5	ZA40AZ38	17,41
40	5	ZA40AZ40	17,41
42	5	ZA40AZ42	17,41

Light serie simple clamp, plastic smooth profile

Abrazadera ligera simple completa, plásticos perfil liso

Einfache Befestigungsschelle komplett - Leichte Serie einfach, Plastikteile glatt

Collier de fixation simple série légère, complet, plastic profil lisse



DN	GRUPO GROUP	Referencia Part n°	€
8	1	ZA40AZ08PL	12,11
10	1	ZA40AZ10PL	12,11
12	1	ZA40AZ12PL	12,11
1 1/4"	2	ZA40AZ13.2PL	12,78
15	2	ZA40AZ15PL	12,78
3/8"	2	ZA40AZ16.7PL	12,78
18	2	ZA40AZ18PL	12,78
20	3	ZA40AZ20PL	13,66
1/2"	3	ZA40AZ21.3PL	13,66
22	3	ZA40AZ22PL	13,66
25	3	ZA40AZ25PL	13,66
3/4"	4	ZA40AZ26.7PL	15,08
28	4	ZA40AZ28PL	15,08
30	4	ZA40AZ30PL	15,08
1"	5	ZA40AZ33.3PL	17,41
35	5	ZA40AZ35PL	17,41
38	5	ZA40AZ38PL	17,41
42	5	ZA40AZ42PL	17,41

Light serie reinforced clamp

Abrazadera ligera reforzada completa

Befestigungsschelle komplett - Leichte Serie verstärkt

Collier de fixation simple série légère renforcé complet



DN	GRUPO GROUP	Referencia Part n°	€
6	1	ZA41AZ06	15,39
8	1	ZA41AZ08	15,39
10	1	ZA41AZ10	15,39
12	1	ZA41AZ12	15,39
1 1/4"	2	NEW ZA41AZ13.2	16,43
14	2	ZA41AZ14	16,43
15	2	ZA41AZ15	16,43
16	2	ZA41AZ16	16,43
18	2	ZA41AZ18	16,43
20	3	ZA41AZ20	17,82
22	3	ZA41AZ22	17,82
23	3	ZA41AZ23	17,82
25	3	ZA41AZ25	17,82
28	4	ZA41AZ28	19,18
30	4	ZA41AZ30	19,18
38	5	ZA41AZ38	22,67
40	5	ZA41AZ40	22,67
42	5	ZA41AZ42	22,67

Light serie reinforced clamp, plastic smooth profile

Abrazadera ligera reforzada completa, plásticos perfil liso

Befestigungsschelle komplett - Leichte Serie verstärkt, Plastikteile glatt

Collier de fixation simple série légère renforcé, complet, plastic profil lisse



DN	GRUPO GROUP	Referencia Part n°	€
8	1	ZA41AZ08PL	15,39
10	1	ZA41AZ10PL	15,39
12	1	ZA41AZ12PL	15,39
1 1/4"	2	ZA41AZ13.2PL	16,43
15	2	ZA41AZ15PL	16,43
3/8"	2	ZA41AZ16.7PL	16,43
18	2	ZA41AZ18PL	16,43
20	3	ZA41AZ20PL	17,82
1/2"	3	ZA41AZ21.3PL	17,82
22	3	ZA41AZ22PL	17,82
25	3	ZA41AZ25PL	17,82
3/4"	4	ZA41AZ26.7PL	19,18
28	4	ZA41AZ28PL	19,18
30	4	ZA41AZ30PL	19,18
1"	5	ZA41AZ33.3PL	22,67
35	5	ZA41AZ35PL	22,67
38	5	ZA41AZ38PL	22,67
42	5	ZA41AZ42PL	22,67

TRΔLE® CLAMPSAbrazaderas TrΔle
Schellen
Colliers TrΔle**Plastics polypropylene simple, light series**

Plásticos polipropileno, serie ligera

Polypropylenteile einfach, Leichte Serie

Plastique polypropylene, série légère



DN	GRUPO GROUP	Referencia Part n°	€
6	1	A106C	0,62
8	1	A108C	0,62
10	1	A110C	0,62
12	1	A112C	0,62
1/4"	2	A213.2C	0,64
14	2	A214C	0,64
15	2	A215C	0,64
3/8"	2	A216.7C	0,65
16	2	A216C	0,64
18	2	A218C	0,64
19	3	A319C	0,84
20	3	A320C	0,84
1/2"	3	A321.3C	0,84
22	3	A322C	0,84
23	3	A323C	0,84
25	3	A325C	0,84
3/4"	4	A426.7C	1,01
28	4	A428C	1,01
30	4	A430C	1,01
32	5	A532C	1,53
1"	5	A533.7C	1,53
35	5	A535C	1,53
38	5	A538C	1,53
40	5	A540C	1,53
42	5	A542C	1,53
44.5	6	A644.5C	2,34
1"1/2	6	A648.3C	2,34
50.8	6	A650.8C	2,34

Price per couple / Precio por pareja / Preis für ein Paar / Prix par paire

Lower plate, light serie

Chapas inferiores, serie ligera

Unterbleche, Leichte Serie

Plaque inférieure, série légère



GRUPO GROUP	Referencia Part n°	€
1	ZAPIN1	9,55
2	ZAPIN2	9,92
3	ZAPIN3	10,35
4	ZAPIN4	10,78
5	ZAPIN5	11,52
6	ZAPIN6	14,36

Upper plate, light serie

Chapas superiores, serie ligera

Oberbleche, Leichte Serie

Plaque supérieure, série légère



GRUPO GROUP	Referencia Part n°	€
1	ZAPS1	2,98
2	ZAPS2	3,30
3	ZAPS3	3,73
4	ZAPS4	4,26
5	ZAPS5	4,95
6	ZAPS6	5,70

Allen screw, light serie

Tornillos Allen, serie ligera

Innensechskant-Schrauben, Leichte Serie

Vis Allen, série légère



ROSCA THREAD	GRUPO GROUP	Referencia Part n°	€
M6	1	ZAVTC1	1,07
M6	2	ZAVTC2	0,50
M6	3	ZAVTC3	1,34
M6	4	ZAVTC4	1,75
M6	5	ZAVTC5	2,26
M6	6	ZAVTC6	2,79

Price per unit / Precio por unidad / Preis pro Stück / Prix à l'unité

Hexagonal screw, light serie

Tornillos Hexagonales, serie ligera

Hexagonal-Schrauben, Leichte Serie

Vis Hexagonnel, série légère



ROSCA THREAD	GRUPO GROUP	Referencia Part n°	€
M6	1	ZAVTE1	1,07
M6	2	ZAVTE2	1,21
M6	3	ZAVTE3	1,48
M6	4	ZAVTE4	1,57
M6	5	ZAVTE5	2,32
M6	6	ZAVTE6	3,36

Price per unit / Precio por unidad / Preis pro Stück / Prix à l'unité

Plates to pile up clamps, light serie

Chapas para apilar abrazaderas, serie ligera

Blech zum Stapeln von Schellen, Serie Leicht

Plaques pour empiler colliers, série légère



GRUPO GROUP	Referencia Part n°	€
1	ZAPA1	1,38
2	ZAPA2	1,65
4	ZAPA4	2,13
5	ZAPA5	2,41
3	ZAPA3	1,89
6	ZAPA6	3,38

TRALE® CLAMPS

Abrazaderas TrΔle
Schellen
Colliers TrΔle

Elongated Weld Plate Light Series

NEW

Chapa Atornillar, Serie ligera

Längliche Schweißplatte Leichte Serie

Plaque à souder allongée, série légère



GRUPO GROUP	Referencia Part n°	€
1	ZAPT1	6,92
2	ZAPT2	7,30
3	ZAPT3	7,47
4	ZAPT4	7,81
5	ZAPT5	8,15

TRALE®

ABRAZADERAS | CLAMPS

UNE TUS SISTEMAS DE TUBERÍA DE FORMA SEGURA
JOIN PIPE SYSTEMS SECURELY

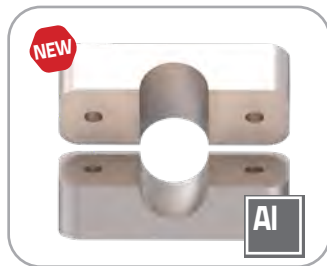

CONSULTA EL
CATÁLOGO DE
CONDUCCIONES

CHECK OUR
CONNECTORS
CATALOGUE



TRΔLE® CLAMPS

Abrazaderas TrΔle

Schellen

Colliers TrΔle

Double clamp - parallel

Abrazaderas dobles completas

Doppelte Befestigungsschellen - komplett

Colliers de fixation doubles complets



DN	GRUPO GROUP	Referencia Part n°	€
6	1	ZAZCFS06	11,25
8	1	ZAZCFS08	11,25
10	1	ZAZCFS10	11,25
12	1	ZAZCFS12	11,25
14	2	ZAZCFS14	22,23
15	2	ZAZCFS15	22,23
16	2	ZAZCFS16	22,23
18	2	ZAZCFS18	22,23
20	3	ZAZCFS20	23,95
22	3	ZAZCFS22	23,95
25	3	ZAZCFS25	23,95
28	4	ZAZCFS28	29,16
30	4	ZAZCFS30	29,16
35	5	ZAZCFS35	34,62
38	5	ZAZCFS38	34,62
40	5	ZAZCFS40	34,62
42	5	ZAZCFS42	34,62

Double Lower plate

Chapas inferiores

Unterbleche

Plaques inférieures à souder double



ROSCA THREAD	GRUPO GROUP	Referencia Part n°	€
M6	1	ZADPIN1	6,23
M8	2	ZADPIN2	14,24
M8	3	ZADPIN3	15,16
M8	4	ZADPIN4	16,20
M8	5	ZADPIN5	17,91

Double Upper plate

Chapas superiores

Oberbleche

Plaques supérieures de protection double



GRUPO GROUP	Referencia Part n°	€
1	ZADPS1	3,21
2	ZADPS2	4,95
3	ZADPS3	5,49
4	ZADPS4	9,35
5	ZADPS5	11,46

Double plastics polypropylene

Plásticos polipropileno dobles

Polypropylenteile doppelt

Double plastiques polypropylene



DN	GRUPO GROUP	Referencia Part n°	€
6	1	AD106C	0,69
8	1	AD108C	0,69
10	1	AD110C	0,69
12	1	AD112C	0,69
14	2	AD213.2C	0,80
14	2	AD214C	0,80
15	2	AD215C	0,80
3/8"	2	AD216.7C	0,80
16	2	AD216C	0,80
18	2	AD218C	0,80
19	3	AD319C	0,97
20	3	AD320C	0,97
1/2"	3	AD321.3C	0,97
22	3	AD322C	0,97
25	3	AD325C	0,97
3/4"	4	AD426.7C	1,22
28	4	AD428C	1,22
30	4	AD430C	1,22
32	5	AD532C	1,89
1"	5	AD533.3C	1,89
35	5	AD535C	1,89
38	5	AD538C	1,89
40	5	AD540C	1,89
42	5	AD542C	1,89

Price per couple / Precio por pareja / Preis für ein Paar / Prix par paire

Hexagonal screw

Tornillos cabeza hexagonal

Hexagonalkopf-Schrauben

Vis hexagonale



ROSCA THREAD	GRUPO GROUP	Referencia Part n°	€
M6	1	ZADVTE1	1,34
M8	2	ZADVTE2	2,67
M8	3	ZADVTE3	2,76
M8	4	ZADVTE4	2,85
M8	5	ZADVTE5	3,81

Price per unit / Precio por unidad / Preis pro Stück / Prix à l'unité

TRALE® CLAMPS

Abrazaderas TrΔle

Schellen

Colliers TrΔle

Heavy Series Stainless Steel Clamps

Abrazaderas Inox Serie pesada completas

Edelstahl-Schelle Schwere Serie

Pinces en acier inoxydable série lourde



DN	GRUPO GROUP	Referencia Part n°	€
6	1	ZAZCPS06	45,53
8	1	ZAZCPS08	45,53
10	1	ZAZCPS10	45,53
12	1	ZAZCPS12	45,53
1 1/4"	1	ZAZCPS13.2	45,53
14	1	ZAZCPS14	45,53
15	1	ZAZCPS15	45,53
16	1	ZAZCPS16	45,53
3/8"	1	ZAZCPS17.2	45,53
18	1	ZAZCPS18	45,53
20	2	ZAZCPS20	55,19
1/2"	2	ZAZCPS21.3	55,19
22	2	ZAZCPS22	55,19
25	2	ZAZCPS25	55,19
3/4"	2	ZAZCPS26.7	55,19
28	2	ZAZCPS28	55,19
30	2	ZAZCPS30	55,19
32	3	ZAZCPS32	68,99
1"	3	ZAZCPS33.3	68,99
35	3	ZAZCPS35	68,99
38	3	ZAZCPS38	68,99
40	3	ZAZCPS40	68,99
42 - 1" 1/4	3	ZAZCPS42	68,99
45	4	ZAZCPS45	137,98
48-1" 1/2	4	ZAZCPS48	137,98
50	4	ZAZCPS50	137,98
55	4	ZAZCPS55	137,98
2"	4	ZAZCPS60.3	137,98
65	4	ZAZCPS65	137,98
70	4	ZAZCPS70	137,98

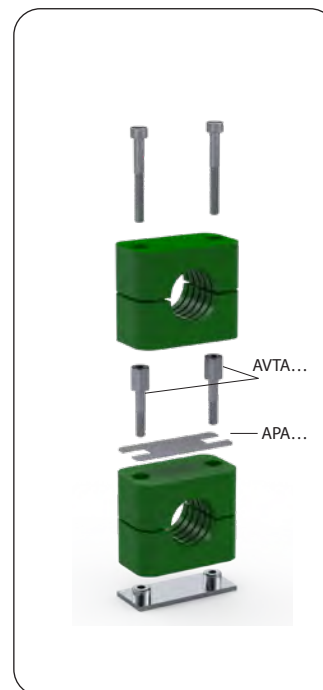
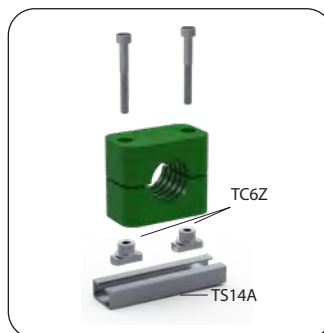
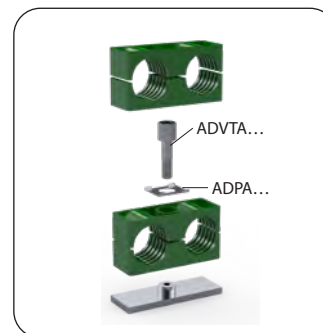
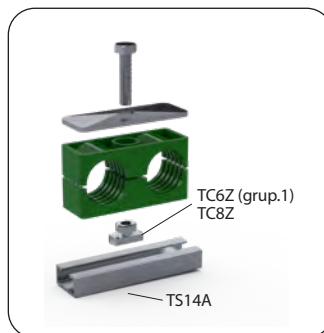
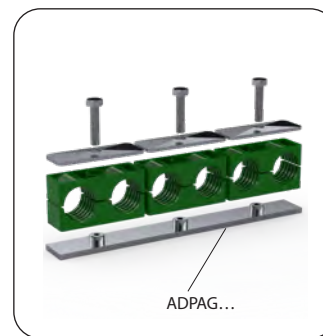

TRALE® CLAMPS

Abrazaderas TrΔle

Schellen

Colliers TrΔle

Plastics polypropylene, heavy series

Plásticos polipropileno, serie pesada

Polypropylenteil, Schwere Serie

Plastique polypropylene, série lourde



DN	GRUPO GROUP	Referencia Part n°	€
6	1	AMPP106C	1,66
8	1	AMPP108C	1,66
10	1	AMPP110C	1,66
12	1	AMPP112C	1,66
1/4"	1	AMPP113.2C	1,66
14	1	AMPP114C	1,66
15	1	AMPP115C	1,66
16	1	AMPP116C	1,66
3/8"	1	AMPP117.2C	1,66
18	1	AMPP118C	1,66
20	2	AMPP220C	1,80
1/2"	2	AMPP221.3C	1,80
22	2	AMPP222C	1,80
25	2	AMPP225C	1,80
3/4"	2	AMPP226.7C	1,80
28	2	AMPP228C	1,80
30	2	AMPP230C	1,80
30	3	AMPP330C	2,56
32	3	AMPP332C	2,56
1"	3	AMPP333.3C	2,56
35	3	AMPP335C	2,56
38	3	AMPP338C	2,56
40	3	AMPP340C	2,56
42	3	AMPP342C	2,56
38	4	AMPP438C	7,27
42-1" 1/4	4	AMPP442C	7,27
45	4	AMPP445C	7,27
48-1" 1/2	4	AMPP448C	7,27
50	4	AMPP450C	7,27
55	4	AMPP455C	7,27
2"	4	AMPP460.3C	7,27
65	4	AMPP465C	7,27
70	4	AMPP470C	7,27

Price per couple / Precio por pareja / Preis für ein Paar / Prix par paire

Lower plate, heavy serie

Chapas inferiores, serie pesada

Unterbleche, Schwere Serie

Plaque inférieure, série lourde



ROSCA THREAD	GRUPO GROUP	Referencia Part n°	€
M10	1	ZAPINP1	35,54
M10	2	ZAPINP2	46,85
M10	3	ZAPINP3	58,14
M12	4	ZAPINP4	88,59

Upper plate, heavy serie

Chapas superiores, serie pesada

Oberbleche, Schwere Serie

Plaque supérieure, série lourde



GRUPO GROUP	Referencia Part n°	€
1	ZAPSP1	16,26
2	ZAPSP2	18,42
3	ZAPSP3	24,11
4	ZAPSP4	55,15

Screw, heavy serie

Tornillos, serie pesada

Schrauben, Schwere Serie

Vis, série lourde



ROSCA THREAD	GRUPO GROUP	Referencia Part n°	€
M10	1	ZAVTEP1	4,21
M10	2	ZAVTEP2	5,00
M10	3	ZAVTEP3	5,72
M12	4	ZAVTEP4	12,08

Price per unit / Precio por unidad / Preis pro Stück / Prix à l'unité

Rail accessories

Accesorios para carril

Zubehör Schiene

Accessoires pour rail



ROSCA THREAD	DETALLE DESCRIPTION	Referencia Part n°	€
M6	NUT	TC6I	11,45
M8	NUT	TC8I	15,97
--	RAIL	TS11I	66,68
M10	NUT	TC10I	17,57
--	RAIL	TS14I	73,73

SISTEMA LOGÍSTICO INTELIGENTE. OPTIMIZAMOS TUS ENVÍOS

Cada día más cerca de ti. Compañía global.



www.dicsaes.com



Closer to you everyday. Worldwide company

SMART LOGISTICS SYSTEM. WE OPTIMIZE DELIVERY OPERATIONS

BSP ADAPTORS | 175

Adaptadores BSP
Adapter BSP
Adapteurs BSP

NPT ADAPTORS | 184

Adaptadores NPT
Adapter NPT
Adapteurs NPT

O’RING BOSS ADAPTORS | 188

Adaptadores O’Ring Boss
Adapter O’Ring Boss
Adapteurs O’Ring Boss

ORFS ADAPTORS | 190

Adaptadores ORFS
Adapter ORFS
Adapteurs ORFS

04

ADAPTORS

Adaptadores
Adaptors
Adapteurs

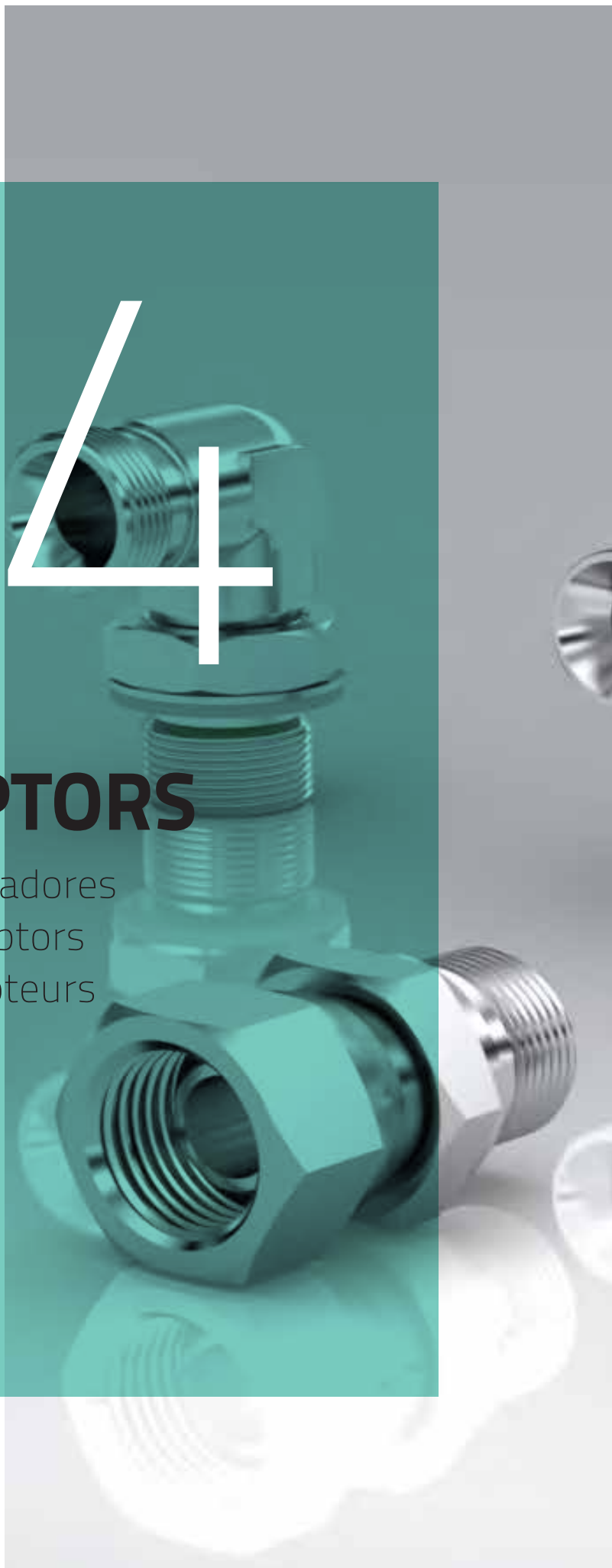

BSP ADAPTORS

Adaptadores BSP
Adapter BSP
Adapteurs BSP

Straight male adaptors ▪ Uniones rectas macho ▪ Gerade Verschraubungen m ▪ Unions mâle

175



Z1010

Z1010_WD

Z1011

Z1020

Z1020_WD

Z1016

Z1014

Z1024

Z1012



Z1022

Adaptors male-female ▪ Uniones rectas macho-hembra ▪ Gerade Verschraubungen m - w ▪ Unions mâle-femelle

176



Z1060

Z1060

Z1172

Z1170

Z1173

Z1150

Plugs ▪ Tapones ▪ Stopfen ▪ Bouchons

178



Z1072

Z1070

Z1075

Female adaptors and bulkheads ▪ Uniones hembra y pasatabiques ▪ Verschraubungen w und Schottverschraubungen ▪ Unions femelle et passe-cloison

179



Z1310

Z1031

Z1031

Z1160

Z1161

Banjos ▪ Orientables ▪ Ringaugen ▪ Adapteurs orientables

180



Z1090

Z1092

Z1140

Joints ▪ Juntas metal FKM ▪ USIT-Dichtringe ▪ Bague BS

180



ZVT210

ZVT320

Elbows ▪ Codos accesorias ▪ Winkel - W ▪ Adapteurs coude accessoirel

181



Z1194

ZA1196

Z1195

ZA1195

Forging elbows ▪ Codos en forja ▪ W-Guss-Stücke ▪ Adapteurs coude en forge

182



Z1190

Z1192

Z1197

Z1191

Z1193

Z1196

Z1198

Z1183

BSP ADAPTORS

Adaptadores BSP
Adapter BSP
Adpteurs BSP

Forging Tees and croos ▪ Te y cruces en forja ▪ T-Guss-Stück und überqueren ▪ Adpteurs Tés en forge et des croix

183



Z1220



Z1222



Z1224



Z1228



Z1226



Z1221



Z1223



Z1227

NPT ADAPTORSAdaptadores NPT
Adapter NPT
Adapteurs NPT

Straight male adaptors ▪ Uniones rectas macho-macho ▪ Gerade Verschraubungen m - m ▪ Unions mâle | 184

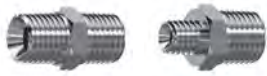

Z1015

ZN1015

Adaptors male-female ▪ Uniones rectas macho-hembra ▪ Gerade Verschraubungen m - w ▪ Unions mâle-fe-
melle | 184

ZN1060

ZN1150

ZN1170

ZN1174

Plugs ▪ Tapones ▪ Stopfen ▪ Bouchons | 185



ZN1072

ZN1070

ZN1071

Female adaptors and bulkheads ▪ Uniones hembra y pasatabiques ▪ Verschraubungen w und
Schottverschraubungen ▪ Unions femelle et passe cloisson | 185

ZN1031

Forging elbows ▪ Codos en forja ▪ W-Guss-Stücke ▪ Adapteurs coude en forge | 186



ZN1190

ZN1193

ZN1196

ZN1198

ZN1396

ZN1393

Forging tees ▪ Tes en forja ▪ T-Verschraubungen Guss ▪ Adapteurs Té en forge | 187



ZN1220

ZN1226

O'RING BOSS ADAPTORS

Adaptadores O'Ring Boss
Adapter O'Ring Boss
Adapteurs O'Ring Boss

Straight male adaptors ▪ Uniones rectas macho ▪ Gerade Verschraubungen m ▪ Unions mâle

188



ZS6464

ZS220

ZS3474

ZS6401

Adaptors male-female ▪ Uniones rectas macho-hembra ▪ Gerade Verschraubungen m - w ▪ Unions mâle-femelle

188



ZS380

ZS6405

Plugs ▪ Tapones ▪ Stopfen ▪ Bouchons

188



ZS6408

ZS6409

Forging elbows and tees ▪ Codos en forja ▪ W- und T-Guss-Stücke ▪ Adapteurs coude et té en forge

189



ZS575

Forging Tees ▪ Tes en forja ▪ T-Verschraubungen Guss ▪ Adapteurs Té en forge

189



ZS6803

ZS6804

ORFS ADAPTORS

Adaptadores ORFS

Adapter ORFS

Adpteurs ORFS

ORFS Nuts and nipples ▪ Conos y tuercas ORFS ▪ Ü-Muttern und Konusse ORFS ▪ Écrous et collets ORFS | 190



ZOR102

ZOR1273

Plugs ▪ Tapones ▪ Verschlüsse ▪ Bouchons | 190



ZOR104

ZOR105

ORFS Straight unions ▪ Uniones rectas ORFS ▪ Gerade ORFS-Verschraubungen ▪ Unions droites ORFS | 190



ZOR200

ZOR202

ZOR1017

ZOR106

ZOR301

ZOR204

ZOR302

ZOR305

ORFS Elbows ▪ Codos en forja ORFS ▪ ORFS-Winkel - w ORFS ▪ Coudes ORFS | 192



ZOR405

ZOR600

ORFS Tees ▪ Tes en forja ORFS ▪ T-Verschraubungen ORFS ▪ Tés ORFS | 192



ZOR700

ZOR701

ZOR702

JVORFS

BSP ADAPTORS

Adaptadores BSP

Adapter BSP

Adapteurs BSP

Adaptor male BSP 60° - male BSP 60°

Adaptador macho - macho BSP cono 60°

Doppelnippel AGR-AGR

Adapteur mâle BSP - mâle BSP cone 60°



ROSCA THREAD	Referencia Part n°	€
1/8" BSP	1/8" BSP	Z101002 8,38
1/4" BSP	1/4" BSP	Z101004 8,33
1/4" BSP	1/4" BSP	Z101004H19 10,77
3/8" BSP	3/8" BSP	Z101006 9,81
1/2" BSP	1/2" BSP	Z101008 13,38
5/8" BSP	5/8" BSP	Z101010 29,13
3/4" BSP	3/4" BSP	Z101012 20,04
1" BSP	1" BSP	Z101016 38,87
1"1/4 BSP	1"1/4 BSP	Z101020 59,28
1"1/2 BSP	1"1/2 BSP	Z101024 70,55
2" BSP	2" BSP	Z101032 108,60
2" BSP	2" BSP	Z101032H70 145,54
2"1/2 BSP	2"1/2 BSP	NEW Z101040 185,89
3" BSP	3" BSP	NEW Z101048 317,41

Adaptor male BSP 60° - male BSP 60° captive seal

Adaptador macho - macho BSP cono 60° con junta encastrada

Doppelnippel AGR-AGR WD

Adapteur mâle BSP - mâle BSP cone 60° avec joint plat



ROSCA THREAD	Referencia Part n°
1/4" BSP	1/4" BSP Z101004WD
3/8" BSP	3/8" BSP Z101006WD
1/2" BSP	1/2" BSP Z101008WD
3/4" BSP	3/4" BSP Z101012WD
1" BSP	1" BSP Z101016WD

Adaptor male BSP - male BSP flat seat

Adaptador macho - macho BSP asiento plano

Doppelnippel AGR-AGR flachdichtend

Adapteur mâle BSP - mâle BSP fond plat



ROSCA THREAD	Referencia Part n°	€
1/4" BSP	1/4" BSP	Z101104 12,07
3/8" BSP	3/8" BSP	Z101106 14,72
1/2" BSP	1/2" BSP	Z101108 17,42
3/4" BSP	3/4" BSP	Z101112 21,20
1" BSP	1" BSP	Z101116 43,53
1"1/4 BSP	1"1/4 BSP	Z101120 69,70
1"1/2 BSP	1"1/2 BSP	Z101124 76,92
2" BSP	2" BSP	Z101132 117,46

Reducer male adaptor BSP 60° - male BSP 60°

Reductor macho - macho BSP cono 60°

Reduziernippel AGR-AGR

Réduction mâle BSP - mâle BSP cone 60°



ROSCA THREAD	Referencia Part n°	€
1/8" BSP	1/4" BSP	Z10200204 8,51
1/8" BSP	1/4" BSP	Z10200204H19 11,47
1/8" BSP	3/8" BSP	Z10200206 15,65
1/4" BSP	3/8" BSP	Z10200406 10,67
1/4" BSP	1/2" BSP	Z10200408 14,93
1/4" BSP	3/4" BSP	Z10200412 23,63
3/8" BSP	1/2" BSP	Z10200608 14,78
3/8" BSP	3/4" BSP	Z10200612 24,86
1/2" BSP	3/4" BSP	Z10200812 20,76
1/2" BSP	1" BSP	Z10200816 38,33
5/8" BSP	1/2" BSP	Z10201008 34,65
5/8" BSP	3/4" BSP	Z10201012 38,19
3/4" BSP	1" BSP	Z10201216 39,66
3/4" BSP	1"1/4 BSP	Z10201220 61,13
1" BSP	1"1/4 BSP	Z10201620 59,33
1" BSP	1"1/2 BSP	Z10201624 78,50
1"1/4 BSP	1"1/2 BSP	Z10202024 75,47
1"1/4 BSP	2" BSP	Z10202032 124,65
1"1/2 BSP	2" BSP	Z10202432 118,77
1"1/2 BSP	2" BSP	Z10202432H70 150,68
2" BSP	2"1/2 BSP	NEW Z10203240 199,69
2" BSP	3" BSP	NEW Z10203248 315,71
2"1/2 BSP	3" BSP	NEW Z10204048 313,90

Reducer male adaptor BSP 60° - male BSP 60° captive seal

Reductor macho - macho BSP cono 60° con junta encastrada

Reduziernippel AGR-AGR WD

Réduction mâle BSP - mâle BSP cone 60° avec joint plat



ROSCA THREAD	Referencia Part n°
1/4" BSP	3/8" BSP Z10200406WD
1/4" BSP	3/8" BSP Z10200408WD
3/8" BSP	1/2" BSP Z10200608WD
1/2" BSP	3/4" BSP Z10200812WD
3/4" BSP	1" BSP Z10201216WD

Adaptor male BSPT - male BSPT

Adaptador macho - macho BSPT

Doppelnippel AGRR-AGRR

Adapteur mâle gaz conique BSPT - mâle gaz conique BSPT



ROSCA THREAD	Referencia Part n°	€
1/4" BSPT	1/8" BSPT	Z10160402 14,79
1/4" BSPT	1/4" BSPT	Z10160404 10,10
3/8" BSPT	3/8" BSPT	Z10160606 13,54
1/2" BSPT	1/2" BSPT	Z10160808 14,59
3/4" BSPT	3/4" BSPT	Z10161212 21,80
1" BSPT	1" BSPT	Z10161616 45,32
1" 1/4 BSPT	1" 1/4 BSPT	Z10162020 70,73
1" 1/2 BSPT	1" 1/2 BSPT	Z10162424 97,06
2" BSPT	2" BSPT	Z10163232 134,31

BSP ADAPTORS

Adaptadores BSP
Adapter BSP
Adapteurs BSP

Adaptor male BSP 60° - male NPT

Adaptador macho BSP 60° - macho NPT

Doppelnippel AGR-AGN

Adapteur mâle BSP cone 60° - mâle BRIGGS (NPT)



ROSCA THREAD		Referencia Part n°	€
1/8" BSP	1/8" NPT	Z101402	10,21
1/4" BSP	1/4" NPT	Z101404	8,99
3/8" BSP	3/8" NPT	Z101406	12,34
1/2" BSP	1/2" NPT	Z101408	13,27
3/4" BSP	3/4" NPT	Z101412	20,36
1" BSP	1" NPT	Z101416	32,65
1"1/4 BSP	1"1/4 NPT	Z101420	53,99
1"1/2 BSP	1"1/2 NPT	Z101424	76,40
2" BSP	2" NPT	Z101432	113,34

Reducer adaptor male BSP 60° - male NPT

Reductor macho BSP 60° - macho NPT

Reduziernippel AGR-AGN

Réduction mâle BSP cone 60° - mâle BRIGGS NPT



ROSCA THREAD		Referencia Part n°	€
1/8" BSP	1/4" NPT	Z10240204	18,14
1/4" BSP	1/8" NPT	Z10240402	19,34
1/4" BSP	3/8" NPT	Z10240406	16,28
1/4" BSP	1/2" NPT	Z10240408	21,08
3/8" BSP	1/4" NPT	Z10240604	18,38
3/8" BSP	1/2" NPT	Z10240608	20,50
3/8" BSP	3/4" NPT	Z10240612	24,67
1/2" BSP	3/8" NPT	Z10240806	21,16
1/2" BSP	3/4" NPT	Z10240812	23,69
5/8" BSP	3/4" NPT	Z10241012	42,69
3/4" BSP	1/4" NPT	Z10241204	40,50
3/4" BSP	3/8" NPT	Z10241206	26,57
3/4" BSP	1/2" NPT	Z10241208	30,88
3/4" BSP	1" NPT	Z10241216	39,36
3/4" BSP	1"1/4 NPT	Z10241220	80,14
3/4" BSP	1"1/2 NPT	Z10241224	84,51
1" BSP	1/2" NPT	Z10241608	38,50
1" BSP	3/4" NPT	Z10241612	37,11
1" BSP	1"1/4 NPT	Z10241620	67,99
1"1/4 BSP	1" NPT	Z10242016	72,89
1"1/4 BSP	1"1/2 NPT	Z10242024	80,74
1"1/2 BSP	1"1/4 NPT	Z10242420	88,68
1"1/2 BSP	2" NPT	Z10242432	120,00
2" BSP	1"1/2 NPT	Z10243224	115,65

Adaptor male BSP 60° - male BSPT

Adaptador macho BSP 60° - macho BSPT

Doppelnippel AGR-AGRR

Adapteur mâle BSP cone 60° - mâle gaz conique
BSPT



ROSCA THREAD		Referencia Part n°	€
1/8" BSP	1/8" BSPT	Z101202	9,44
1/4" BSP	1/4" BSPT	Z101204	8,41
3/8" BSP	3/8" BSPT	Z101206	10,70
1/2" BSP	1/2" BSPT	Z101208	13,20
3/4" BSP	3/4" BSPT	Z101212	17,97
1" BSP	1" BSPT	Z101216	38,59
1"1/4 BSP	1"1/4 BSPT	Z101220	55,78
1"1/2 BSP	1"1/2 BSPT	Z101224	74,62
2" BSP	2" BSPT	Z101232	107,61

Reducer adaptor male BSP 60° - male BSPT

Reductor macho BSP 60° - macho BSPT

Reduziernippel AGR-AGRR

Réduction mâle BSP cone 60° - mâle gaz conique
BSPT



ROSCA THREAD		Referencia Part n°	€
1/8" BSP	1/4" BSPT	Z10220204	23,17
1/4" BSP	1/8" BSPT	Z10220402	16,34
1/4" BSP	3/8" BSPT	Z10220406	18,09
1/4" BSP	1/2" BSPT	Z10220408	21,01
1/4" BSP	3/4" BSPT	Z10220412	39,32
3/8" BSP	1/2" BSPT	Z10220608	13,95
3/8" BSP	3/4" BSPT	Z10220612	31,07
1/2" BSP	1/4" BSPT	Z10220804	26,10
1/2" BSP	3/8" BSPT	Z10220806	19,41
1/2" BSP	3/4" BSPT	Z10220812	25,07
1/2" BSP	1" BSPT	Z10220816	40,85
5/8" BSP	3/4" BSPT	Z10221012	23,58
3/4" BSP	1/4" BSPT	Z10221204	31,89
3/4" BSP	3/8" BSPT	Z10221206	21,62
3/4" BSP	1/2" BSPT	Z10221208	24,28
3/4" BSP	1" BSPT	Z10221216	31,03
1" BSP	3/4" BSPT	Z10221612	34,93
1" BSP	1"1/4 BSPT	Z10221620	64,91
1"1/4 BSP	1" BSPT	Z10222016	73,81
1"1/4 BSP	1"1/2 BSPT	Z10222024	78,08
1"1/2 BSP	1"1/4 BSPT	Z10222420	83,09
1"1/2 BSP	2" BSPT	Z10222432	130,53

Adaptor male BSP 60° - fixed female BSP

Prolongador macho BSP 60° - hembra fija BSP

Adapter AGR-IGR

Prolongateur mâle BSP cone 60° - femelle gaz fixe



ROSCA(M) THREAD (M)	ROSCA(H) THREAD (F)	Referencia Part n°	€
1/8" BSP	1/8" BSP	Z106002	18,18
1/4" BSP	1/4" BSP	Z106004	13,58
3/8" BSP	3/8" BSP	Z106006	14,18
1/2" BSP	1/2" BSP	Z106008	17,58
3/4" BSP	3/4" BSP	Z106012	26,79
1" BSP	1" BSP	Z106016	37,91
1"1/4 BSP	1"1/4 BSP	Z106020	83,00
1"1/2 BSP	1"1/2 BSP	Z106024	91,18
2" BSP	2" BSP	Z106032	140,73

BSP ADAPTORS

Adaptadores BSP
Adapter BSP
Adapteurs BSP

Reducer adaptor male BSP 60° - fixed female BSP

Reductor macho BSP 60° - hembra fija BSP

Reduzierstück AGR fest - IGR fest

Prolongateur réducteur mâle BSP cone 60° - femelle gaz



ROSCA (M) THREAD (M)	ROSCA (H) THREAD (F)	Referencia Part n°	€
1/8" BSP	1/4" BSP	Z10600204	15,93
1/8" BSP	3/8" BSP	Z10600206	24,70
1/4" BSP	1/8" BSP	Z10600402	17,43
1/4" BSP	3/8" BSP	Z10600406	22,57
1/4" BSP	1/2" BSP	Z10600408	27,41
3/8" BSP	1/4" BSP	Z10600604	18,24
3/8" BSP	1/2" BSP	Z10600608	23,48
1/2" BSP	1/4" BSP	Z10600804	25,88
1/2" BSP	3/8" BSP	Z10600806	20,93
1/2" BSP	3/4" BSP	Z10600812	26,40
1/2" BSP	1" BSP	Z10600816	52,12
3/4" BSP	3/8" BSP	Z10601206	25,73
3/4" BSP	1/2" BSP	Z10601208	22,50
3/4" BSP	1" BSP	Z10601216	45,60
1" BSP	3/4" BSP	Z10601612	46,20
1" BSP	1" 1/4 BSP	Z10601620	84,49
1" BSP	1" 1/2 BSP	Z10601624	115,94
1" 1/4 BSP	1" BSP	Z10602016	76,18
1" 1/2 BSP	1" 1/4 BSP	Z10602420	92,84
1" 1/2 BSP	2" BSP	Z10602432	141,73
2" BSP	1" 1/2 BSP	Z10603224	138,14

Adaptor BSP 60° swivel female - BSP 60° swivel female

Adaptador hembra giratoria - hembra giratoria BSP 60°

Adapter BSP (60°) w mit Drallmutter

Adapteur femelle tournante BSP 60° - femelle tournante BSP 60°



ROSCA THREAD	Referencia Part n°	€
1/4" BSP	Z117204	18,32
3/8" BSP	Z117206	22,36
1/2" BSP	Z117208	26,33
3/4" BSP	Z117212	32,84
1" BSP	Z117216	54,01
1" 1/4 BSP	Z117220	94,59
1" 1/2 BSP	Z117224	119,27
2" BSP	Z117232	199,14

Adaptor male BSP 60° - swivel female BSP 60°

Adaptador macho - hembra giratoria BSP cono 60°

Adapter m - w mit Drallmutter BSP kon. 60°

Adapteur mâle BSP - femelle tournante BSP cono 60°



ROSCA (M) THREAD (M)	ROSCA (H) THREAD (F)	Referencia Part n°	€
1/4" BSP	1/4" BSP	Z117004	14,89
3/8" BSP	3/8" BSP	Z117006	18,18
1/2" BSP	1/2" BSP	Z117008	23,33
3/4" BSP	3/4" BSP	Z117012	29,78
1" BSP	1" BSP	Z117016	55,26
1" 1/4 BSP	1" 1/4 BSP	Z117020	94,55
1" 1/2 BSP	1" 1/2 BSP	Z117024	114,55
2" BSP	2" BSP	Z117032	209,70

Reducer male BSP 60° - swivel female BSP 60°

Reductor macho - hembra giratoria BSP cono 60°

Reduziernippel AGR-DKR

Réduction mâle BSP - femelle tournante BSP cono 60°



ROSCA (M) THREAD (M)	ROSCA (H) THREAD (F)	Referencia Part n°	€
1/8" BSP	1/4" BSP	Z11730204	15,37
1/4" BSP	1/8" BSP	Z11730402	21,54
1/4" BSP	3/8" BSP	Z11730406	21,40
3/8" BSP	1/4" BSP	Z11730604	23,92
3/8" BSP	1/2" BSP	Z11730608	25,85
1/2" BSP	3/8" BSP	Z11730806	27,78
1/2" BSP	3/4" BSP	Z11730812	35,37
3/4" BSP	1/2" BSP	Z11731208	35,62
3/4" BSP	F 1" BSP	Z11731216	58,72
1" BSP	3/4" BSP	Z11731612	59,56
1" BSP	1" 1/4 BSP	Z11731620	95,23
1" 1/4 BSP	1" BSP	Z11732016	111,69
1" 1/4 BSP	1" 1/2 BSP	Z11732024	124,12
1" 1/2 BSP	1" 1/4 BSP	Z11732420	126,59
1" 1/2 BSP	2" BSP	Z11732432	192,37
2" BSP	1" 1/2 BSP	Z11733224	181,00

BSP ADAPTORS

Adaptadores BSP
Adapter BSP
Adaptateurs BSP

Reducer plug male BSP 60° - fixed female BSP

Tapón reductor macho BSP 60° - hembra fija BSP

Reduziernippel AGR-IGR fest

Bouchon réducteur mâle BSP cone 60° - femelle gaz



ROSCA (M) THREAD (M)	ROSCA (H) THREAD (F)	Referencia Part n°	€
1/4" BSP	1/8" BSP	Z11500402	10,57
3/8" BSP	1/8" BSP	Z11500602	15,90
3/8" BSP	1/4" BSP	Z11500604	17,03
1/2" BSP	1/4" BSP	Z11500804	19,48
1/2" BSP	3/8" BSP	Z11500806	16,64
3/4" BSP	1/2" BSP	Z11501208	19,77
1" BSP	1/2" BSP	Z11501608	34,37
1" BSP	3/4" BSP	Z11501612	30,68
1" 1/4 BSP	3/4" BSP	Z11502012	57,93
1" 1/4 BSP	1" BSP	Z11502016	53,20
1" 1/2 BSP	1" BSP	Z11502416	72,77
2" BSP	1" BSP	Z11503216	107,07
2" BSP	1" 1/4 BSP	Z11503220*	97,39
2" BSP	1" 1/2 BSP	Z11503224	96,83

*Until end of stock / Hasta fin de existencias / Bis zum Ende des Lagerbestandes / Jusqu'à la fin du stock

BSP fixed female plug

Tapón hembra hexagonal rosca BSP

Verschlussmutter fest BSP

Bouchon femelle gaz



ROSCA THREAD	Referencia Part n°	€
1/4" BSP	Z107204	10,24
3/8" BSP	Z107206	11,76
1/2" BSP	Z107208	13,21
3/4" BSP	Z107212	22,83
1" BSP	Z107216	27,87
1" 1/4 BSP	Z107220	44,30
1" 1/2 BSP	Z107224	63,02
2" BSP	Z107232	87,90

BSP male hexagonal plug

Tapón macho hexagonal rosca BSP 60°

Verschlusssschraube BSP

Bouchon mâle BSP cone 60°



ROSCA THREAD	Referencia Part n°	€
1/8" BSP	Z107002	13,65
1/4" BSP	Z107004	8,15
3/8" BSP	Z107006	10,02
1/2" BSP	Z107008	11,94
3/4" BSP	Z107012	14,48
1" BSP	Z107016	27,65
1" 1/4 BSP	Z107020	47,77
1" 1/2 BSP	Z107024	73,63
2" BSP	Z107032	77,64

BSP swivel female plug

Tapón hembra giratoria BSP cono 60°

Verschlussmutter BSP 60° kon.

Bouchon femelle tournante BSP cone 60°



ROSCA THREAD	Referencia Part n°	€
1/4" BSP	Z107504	9,05
3/8" BSP	Z107506	11,62
1/2" BSP	Z107508	14,93
3/4" BSP	Z107512	20,09
1" BSP	Z107516	31,83
1" 1/4 BSP	Z107520	60,35
1" 1/2 BSP	Z107524	90,06
2" BSP	Z107532	134,41

BSP ADAPTORS

Adaptadores BSP
Adapter BSP
Adpteurs BSP

Adaptor female fixed BSP - female fixed BSP

Manguito redondo roscado hembra BSP

Doppelmuffe IGR fest - IGR fest

Manchon femelle gaz ronde



ROSCA THREAD	Referencia Part n°	€
1/8" BSP	Z131002	9,58
1/4" BSP	Z131004	9,45
3/8" BSP	Z131006	14,32
1/2" BSP	Z131008	17,92
5/8" BSP	Z131010	24,13
3/4" BSP	Z131012	24,76
1" BSP	Z131016	35,10
1"1/4 BSP	Z131020	49,85
1"1/2 BSP	Z131024	65,29
2" BSP	Z131032	90,36

Adaptor hexagonal female fixed BSP - female fixed BSP

Manguito hexagonal roscado hembra BSP

Doppelmuffe IGR fest - IGR fest

Manchon femelle gaz - femelle gaz hexagone



ROSCA THREAD	Referencia Part n°	€
1/4" BSP	Z103104	8,59
3/8" BSP	Z103106	10,97
1/2" BSP	Z103108	15,74
3/4" BSP	Z103112	24,09
1" BSP	Z103116	36,25
1"1/4 BSP	Z103120	74,14
1"1/2 BSP	Z103124	82,47

Reducer hexagonal female fixed BSP - female fixed BSP

Manguito reducción hexagonal roscado hembra BSP

Reduziernippel IGR fest - IGR fest

Manchon réducteur femelle gaz - femelle gaz hexagone



NEW

ROSCA THREAD	Referencia Part n°	€
3/8" BSP 1/4" BSP	Z10310604	18,46*
1/2" BSP 1/4" BSP	Z10310804	26,48*
1/2" BSP 3/8" BSP	Z10310806	*
3/4" BSP 1/2" BSP	Z10311208	40,54*
1" BSP 3/4" BSP	Z10311612	*

Straight bulkhead adaptor BSP 60° without nut

Pasatabiques sin tuerca BSP cono 60°

Gerader Schottadapter DIN 3910 Form ohne M+S - GSA-X

Passe-cloison mâle BSP 60° - mâle BSP 60° sans équiper



ROSCA THREAD	Referencia Part n°	€
1/4" BSP	Z116004	18,91
3/8" BSP	Z116006	22,19
1/2" BSP	Z116008	29,81
3/4" BSP	Z116012	35,67
1" BSP	Z116016	61,64
1" 1/4 BSP	Z116020	87,82
1" 1/2 BSP	Z116024	122,62
2" BSP	Z116032	185,41

Conter nut for BSP bulkhead

Tuerca pasatabiques BSP

Gegenmuttern DIN 80705 für Schottverschraubungen - GM

Contre-écrou passe-cloison gaz



ROSCA THREAD	Referencia Part n°	€
1/4" BSP	Z116104	4,53
3/8" BSP	Z116106	6,31
1/2" BSP	Z116108	7,37
3/4" BSP	Z116112	10,53
1" BSP	Z116116	13,53
1" 1/4 BSP	Z116120	27,85
1" 1/2 BSP	Z116124	36,40
2" BSP	Z116132	45,24

BSP ADAPTORS

Adaptadores BSP
Adapter BSP
Adapteurs BSP

BSP Bolt for banjo

Tornillo orientable simple BSP

Einfache Hohlschraube BSP für Ringauge

Vis creuse simple pour banjo BSP



ROSCA THREAD	Referencia Part n°	€
1/8" BSP	Z109002	19,88
1/4" BSP	Z109004	11,42
3/8" BSP	Z109006	16,46
1/2" BSP	Z109008	21,93
3/4" BSP	Z109012	38,18
1" BSP	Z109016	50,06

Metric bolt for banjo

Tornillo orientable simple Métrico

Einfache Hohlschraube metr. für Ringauge

Vis creuse simple for banjo Métrique



ROSCA THREAD	Referencia Part n°	€
M12X1.5	Z109212	16,54
M14X1.5	Z109214	15,91
M16X1.5	Z109216	16,70
M18X1.5	Z109218	20,61
M22X1.5	Z109222	20,75
M26X1.5	Z109226	43,79
M30X2	Z109230	48,99

BSP Banjo-BSP male (60°)

Esférico BSP - macho BSP (60°)

Ringauge BSP-m BSP (60°)

Banjo passage gaz x mâle BSP (60°)



ROSCA THREAD	Ø	Referencia Part n°	€
1/4" BSP	1/4"	Z114004	*
3/8" BSP	3/8"	Z114006	*
1/2" BSP	1/2"	Z114008	*
3/4" BSP	3/4"	Z114012	*
1" BSP	1"	Z114016	*

BSP Bonded Seal FKM Self-centering

Juntas metal FKM Gas Autocentrantes

USIT-Ringe FKM GAS Selbstzentrierend

Bague BS gaz FKM auto-centrée



ROSCA THREAD	Referencia Part n°	€
1/8" BSP	ZVT21002	1,31
1/4" BSP	ZVT21004	1,09
3/8" BSP	ZVT21006	1,32
1/2" BSP	ZVT21008	2,15
5/8" BSP	ZVT21010	3,90
3/4" BSP	ZVT21012	2,82
1" BSP	ZVT21016	5,07
1" 1/4 BSP	ZVT21020	8,08
1" 1/2 BSP	ZVT21024	9,89
2" BSP	ZVT21032	13,07
2" 1/2 BSP	ZVT21040	39,83

Metric Bonded Seal in FKM Self-centering

Juntas metal FKM Métricas Autocentrantes

USIT-Dichtringe FKM metr.Selbstzentrierend

Bague BS Métrique FKM auto-centrée



ROSCA THREAD	Referencia Part n°	€
M6X1	ZVT32006	0,62
M8X1	ZVT32008	1,46
M10X1	ZVT32010	1,81
M12X1,5	ZVT32012	1,46
M14X1,5	ZVT32014	1,90
M16X1,5	ZVT32016	2,05
M18X1,5	ZVT32018	2,17
M20X1,5	ZVT32020	3,27
M22X1,5	ZVT32022	2,81
M24X1,5	ZVT32024	5,80
M26X1,5	ZVT32026	5,33
M27X1,5	ZVT32027	5,31
M30X2	ZVT32030	7,64
M36X2	ZVT32036	9,35
M42X2	ZVT32042	13,85
M48X2	ZVT32048	15,23

BSP ADAPTORS

Adaptadores BSP

Adapter BSP

Adapteurs BSP

90° Elbow swivel female BSP 60° - male BSP 60°

Codo 90° macho - hembra giratoria BSP cono 60°

90° Winkel AGR-DKR

Adapteur coude 90° accesoriel mâle BSP - femelle tournante BSP cone 60°



ROSCA THREAD		Referencia Part n°	€
1/4" BSP	1/4" BSP	Z119404	46,96
3/8" BSP	3/8" BSP	Z119406	53,39
1/2" BSP	1/2" BSP	Z119408	65,34
3/4" BSP	3/4" BSP	Z119412	93,14
1" BSP	1" BSP	Z119416	108,54
1"1/4 BSP	1"1/4 BSP	Z119420	174,26
1"1/2 BSP	1"1/2 BSP	Z119424	248,02
2" BSP	2" BSP	Z119432	376,38

90° Elbow swivel female BSP 60° - swivel female BSP 60°

Codo 90° hembra giratoria - hembra giratoria BSP cono 60°

90° Winkel DKR-DKR

Adapteur coude 90° femelle tournante BSP - femelle tournante cone 60°



ROSCA THREAD		Referencia Part n°	€
1/4" BSP	1/4" BSP	ZA119604	39,29
3/8" BSP	3/8" BSP	ZA119606	45,44
1/2" BSP	1/2" BSP	ZA119608	54,03
3/4" BSP	3/4" BSP	ZA119612	68,14
1" BSP	1" BSP	ZA119616	105,37
1"1/4 BSP	1"1/4 BSP	ZA119620	177,26

45° Ebow swivel female BSP 60° - male BSP 60°

Codo 45° macho - hembra giratoria BSP cono 60°

45° Bogen AGR-DKR

Adapteur coude 45° accesoriel mâle BSP - femelle tournante BSP cone 60°



ROSCA THREAD		Referencia Part n°	€
1/4" BSP	1/4" BSP	Z119504	51,66
3/8" BSP	3/8" BSP	Z119506	53,50
1/2" BSP	1/2" BSP	Z119508	67,11
3/4" BSP	3/4" BSP	Z119512	82,99
1" BSP	1" BSP	Z119516	110,01
1"1/4 BSP	1"1/4 BSP	Z119520	209,22
1"1/2 BSP	1"1/2 BSP	Z119524	270,28
2" BSP	2" BSP	Z119532	461,30

45° Ebow swivel female BSP 60° - swivel female BSP 60°

Codo 45° hembra giratoria - hembra giratoria BSP cono 60°

45° Bogen DKR-DKR

Adapteur coude 45° femelle tournante BSP - femelle tournante cone 60°



ROSCA THREAD		Referencia Part n°	€
1/4" BSP	1/4" BSP	ZA119504	45,05
3/8" BSP	3/8" BSP	ZA119506	49,47
1/2" BSP	1/2" BSP	ZA119508	57,89
3/4" BSP	3/4" BSP	ZA119512	74,64
1" BSP	1" BSP	ZA119516	104,26
1"1/4 BSP	1"1/4 BSP	ZA119520	244,95

BSP ADAPTORSAdaptadores BSP
Adapter BSP
Adapteurs BSP**90° Adaptor male - male BSP 60°**

Codo 90° macho - macho BSP cono 60°

90° Winkel BSP 90 X BSP 90

Adapteur coude 90° mâle BSP - mâle BSP cono
60° forge

ROSCA THREAD		Referencia Part n°	€
1/8" BSP	1/8" BSP	Z1190002	31,17
1/4" BSP	1/4" BSP	Z1190004	28,11
3/8" BSP	3/8" BSP	Z1190006	32,26
1/2" BSP	1/2" BSP	Z1190008	43,16
3/4" BSP	3/4" BSP	Z1190012	59,39
1" BSP	1" BSP	Z1190016	88,22
1"1/4 BSP	1"1/4 BSP	Z1190020	169,71
1"1/2 BSP	1"1/2 BSP	Z1190024	180,77

90° Adaptor male BSP 60° - male BSPT

Codo 90° macho BSP 60° - macho BSPT

90° Winkel AGR-AG BSPT

Adapteur coude 90° mâle BSP cono 60° - mâle gaz
conique BSPT forge

ROSCA THREAD		Referencia Part n°	€
1/8" BSP	1/8" BSPT	Z119202	30,63
1/4" BSP	1/4" BSPT	Z119204	23,29
3/8" BSP	3/8" BSPT	Z119206	32,86
1/2" BSP	1/2" BSPT	Z119208	41,87
3/4" BSP	3/4" BSPT	Z119212	59,50
1" BSP	1" BSPT	Z119216	87,00
1"1/4 BSP	1"1/4 BSPT	Z119220	150,73
1"1/2 BSP	1"1/2 BSPT	Z119224	187,36

90° Adjustable stud elbow male-male BSP

Codo 90° regulable macho - macho BSP

90° Winkel einstellbar m - m BSP

Coude 90° orientable mâle - mâle BSP



ROSCA THREAD		Referencia Part n°	€
1/4" BSP	1/4" BSP	Z119704	27,93
3/8" BSP	3/8" BSP	Z119706	40,34
1/2" BSP	1/2" BSP	Z119708	62,10
3/4" BSP	3/4" BSP	Z119712	85,51
1" BSP	1" BSP	Z119716	138,39

90° Adaptor male BSP 60° - male NPT

Codo 90° macho BSP 60° - macho NPT

90° Winkel AGR-AGN

Adapteur coude 90° mâle BSP 60° - mâle NPT
forge

ROSCA THREAD		Referencia Part n°	€
1/4" BSP	1/4" NPT	Z11910404	28,25
3/8" BSP	3/8" NPT	Z11910606	39,95
1/2" BSP	1/2" NPT	Z11910808	41,77
3/4" BSP	3/4" NPT	Z11911212	70,61
1" BSP	1" NPT	Z11911616	84,09

90° Adaptor male - swivel female BSP 60°

Codo 90° macho - hembra giratoria BSP cono 60°

90° Winkel m - w BSP (60°) kon.

Adapteur coude 90° mâle BSP - femelle tournante
BSP cono 60° forge

ROSCA THREAD		Referencia Part n°	€
1/8" BSP	1/8" BSP	Z119302	33,67
1/4" BSP	1/4" BSP	Z119304	28,26
3/8" BSP	3/8" BSP	Z119306	39,33
1/2" BSP	1/2" BSP	Z119308	44,71
3/4" BSP	3/4" BSP	Z119312	65,52
1" BSP	1" BSP	Z119316	89,90
1"1/4 BSP	1"1/4 BSP	Z119320	147,06
1"1/2 BSP	1"1/2 BSP	Z119324	160,28

90° Adaptor fixed female BSP

Codo 90° hembra fija - hembra fija BSP

90° Winkel w fest BSP

Adapteur coude 90° femelle fixe gaz cylindrique
forge

ROSCA THREAD		Referencia Part n°	€
1/8" BSP	1/8" BSP	Z119602	25,54
1/4" BSP	1/4" BSP	Z119604	31,98
3/8" BSP	3/8" BSP	Z119606	44,02
1/2" BSP	1/2" BSP	Z119608	46,48
3/4" BSP	3/4" BSP	Z119612	66,27
1" BSP	1" BSP	Z119616	91,71

90° Adaptor swivel female BSP 60°Codo 90° hembra giratoria - hembra giratoria BSP
cono 60°90° Winkel w mit Ü-Mutter - w mit Ü-Mutter BSP
(60°) kon.Adapteur coude 90° femelle tournante BSP cono
60° forge

ROSCA THREAD		Referencia Part n°	€
1/4" BSP	1/4" BSP	Z119804	37,32
3/8" BSP	3/8" BSP	Z119806	44,54
1/2" BSP	1/2" BSP	Z119808	55,54
3/4" BSP	3/4" BSP	Z119812	82,56
1" BSP	1" BSP	Z119816	124,73
1"1/4 BSP	1"1/4 BSP	Z119820	227,60
1"1/2 BSP	1"1/2 BSP	Z119824	269,27

45° Adaptor male - swivel female BSP 60°

Codo 45° macho - hembra giratoria BSP cono 60°

45° Winkel m - w Ü-Mutter BSP 60°

Adapteur coude 45° mâle BSP - femelle tournante
BSP cono 60° forge

ROSCA THREAD		Referencia Part n°	€
M 1/4" BSP	H 1/4" BSP	Z118304	46,51
M 3/8" BSP	H 3/8" BSP	Z118306	55,49
M 1/2" BSP	H 1/2" BSP	Z118308	65,32
M 3/4" BSP	H 3/4" BSP	Z118312	105,67
M 1" BSP	H 1" BSP	Z118316	141,82

BSP ADAPTORS

Adaptadores BSP
Adapter BSP
Adapteurs BSP

Tees BSP 60° male

Tes macho - macho - macho BSP cono 60°

T-Stück AGR

Adapteurs Té mâle BSP cone 60° forge



ROSCA THREAD			Referencia Part n°	€
1/4" BSP	1/4" BSP	1/4" BSP	Z122004	36,01
3/8" BSP	3/8" BSP	3/8" BSP	Z122006	45,51
1/2" BSP	1/2" BSP	1/2" BSP	Z122008	51,98
3/4" BSP	3/4" BSP	3/4" BSP	Z122012	74,04
1" BSP	1" BSP	1" BSP	Z122016	112,44
1"1/4 BSP	1"1/4 BSP	1"1/4 BSP	Z122020	165,38
1"1/2 BSP	1"1/2 BSP	1"1/2 BSP	Z122024	250,54

Tees BSP 60° male - male - swivel female

Tes macho - macho - hembra giratoria BSP 60°

T-Stück AGR-AGR-DKR

Adapteurs Té mâle BSP - mâle BSP - femelle tournante BSP cone 60° forge



ROSCA (M) THREAD (M)	ROSCA (H) THREAD (F)	Referencia Part n°	€
1/4" BSP	1/4" BSP	Z122204	42,29
3/8" BSP	3/8" BSP	Z122206	52,64
1/2" BSP	1/2" BSP	Z122208	60,84
3/4" BSP	3/4" BSP	Z122212	92,62
1" BSP	1" BSP	Z122216	134,54
1"1/4 BSP	1"1/4 BSP	Z122220	238,71
1"1/2 BSP	1"1/2 BSP	Z122224	295,06

Tees BSP 60° male - swivel female - male

Tes macho - hembra giratoria - macho BSP 60°

T-Stück AGR-DKR-AGR

Adapteurs Té mâle BSP - femelle tournante - mâle BSP cone 60° forge



ROSCA (M) THREAD (M)	ROSCA (H) THREAD (F)	ROSCA (M) THREAD (M)	Referencia Part n°	€
1/4" BSP	1/4" BSP	1/4" BSP	Z122404	41,83
3/8" BSP	3/8" BSP	3/8" BSP	Z122406	55,72
1/2" BSP	1/2" BSP	1/2" BSP	Z122408	62,03
3/4" BSP	3/4" BSP	3/4" BSP	Z122412	104,60
1" BSP	1" BSP	1" BSP	Z122416	134,54
1"1/4 BSP	1"1/4 BSP	1"1/4 BSP	Z122420	194,81
1"1/2 BSP	1"1/2 BSP	1"1/2 BSP	Z122424	295,06

Tees BSP 60° swivel female

Tes hembras giratorias BSP cono 60°

T-Stücke DKR

Adapteurs Té femelle tournante BSP cone 60° forge



ROSCA THREAD			Referencia Part n°	€
1/4" BSP	1/4" BSP	1/4" BSP	Z122804	52,70
3/8" BSP	3/8" BSP	3/8" BSP	Z122806	62,89
1/2" BSP	1/2" BSP	1/2" BSP	Z122808	76,88
3/4" BSP	3/4" BSP	3/4" BSP	Z122812	121,69
1" BSP	1" BSP	1" BSP	Z122816	157,84
1"1/4 BSP	1"1/4 BSP	1"1/4 BSP	Z122820	278,72
1"1/2 BSP	1"1/2 BSP	1"1/2 BSP	Z122824	369,20

Tees fixed female BSP

Tes hembras fijas BSP

T-BSP IGR fest

Adapteurs Té femelle gaz forge



ROSCA THREAD			Referencia Part n°	€
1/4" BSP	1/4" BSP	1/4" BSP	Z122604	39,11
3/8" BSP	3/8" BSP	3/8" BSP	Z122606	53,04
1/2" BSP	1/2" BSP	1/2" BSP	Z122608	62,58
3/4" BSP	3/4" BSP	3/4" BSP	Z122612	90,02
1" BSP	1" BSP	1" BSP	Z122616	126,53

Tees BSP 60° male - NPT male center - BSP 60° male

Tes macho BSP 60° - macho NPT central - macho BSP 60°

T-Verschraubungen m BSP 60° - m NPT zentral - m BSP 60°

Adapteurs Té mâle BSP 60° - mâle NPT central - mâle BSP 60° forge



ROSCA THREAD			Referencia Part n°	€
1/4" BSP	1/4" NPT	1/4" BSP	Z12210404	34,44
3/8" BSP	3/8" NPT	3/8" BSP	Z12210606	46,54
1/2" BSP	1/2" NPT	1/2" BSP	Z12210808	71,42
3/4" BSP	3/4" NPT	3/4" BSP	Z12211212	79,85
1" BSP	1" NPT	1" BSP	Z12211616	118,82

Tees BSP 60° male - BSP 60° male - NPT lateral male

Tes macho BSP 60° - macho BSP 60° - macho NPT lateral

T-Verschraubungen m BSP 60° - m BSP 60° - m NPT seitl.

Adapteurs Té mâle BSP 60° - mâle BSP 60° - mâle NPT latéral forge



ROSCA THREAD			Referencia Part n°	€
1/4" BSP	1/4" BSP	1/4" NPT	Z12230404	44,18
3/8" BSP	3/8" BSP	3/8" NPT	Z12230606	46,54
1/2" BSP	1/2" BSP	1/2" NPT	Z12230808	78,17
3/4" BSP	3/4" BSP	3/4" NPT	Z12231212	79,85
1" BSP	1" BSP	1" NPT	Z12231616	118,82

Cross fixed female BSP

Cruz hembra fija BSP

Kreuzstück BSP Innengewinde

Croix BSP femelle fixe



ROSCA THREAD	Referencia Part n°	€
1/4" BSP	Z122704	*
3/8" BSP	Z122706	*
1/2" BSP	Z122708	*
3/4" BSP	Z122712	*
1" BSP	Z122716	*

NPT ADAPTORS

Adaptadores NPT
Adapter NPT
Adapteurs NPT

Adaptor male NPT - male NPT

Adaptor macho - macho NPT

Doppelnippel AGN-AGN

Adapteur mâle NPT - mâle NPT



ROSCA THREAD		Referencia Part n°	€
1/4" NPT	1/4" NPT	Z10150404	9,19
3/8" NPT	3/8" NPT	Z10150606	12,23
1/2" NPT	1/2" NPT	Z10150808	13,45
3/4" NPT	3/4" NPT	Z10151212	19,03
1" NPT	1" NPT	Z10151616	44,43
1" 1/4 NPT	1" 1/4 NPT	Z10152020	65,46
1" 1/2 NPT	1" 1/2 NPT	Z10152424	73,58
2" NPT	2" NPT	Z10153232	116,28

Reducer male NPT - male NPT

Reductor macho - macho NPT

Reduziernippel NPT

Réducteur mâle NPT - mâle NPT



ROSCA THREAD		Referencia Part n°	€
1/4" NPT	1/8" NPT	ZN10150402	13,51
3/8" NPT	1/8" NPT	ZN10150602	17,59
3/8" NPT	1/4" NPT	ZN10150604	16,50
1/2" NPT	1/4" NPT	ZN10150804	23,32
1/2" NPT	3/8" NPT	ZN10150806	25,54
3/4" NPT	3/8" NPT	ZN10151206	24,58
3/4" NPT	1/2" NPT	ZN10151208	23,08
1" NPT	1/2" NPT	ZN10151608	37,52
1" NPT	3/4" NPT	ZN10151612	43,77
1" 1/4 NPT	1" NPT	ZN10152016	73,66
1" 1/2 NPT	1" NPT	ZN10152416	102,28
1" 1/2 NPT	1" 1/4 NPT	ZN10152420	96,63

Adaptor male NPT - fixed female NPT

Adaptador macho - hembra fija NPT

Adapter m - w fest NPT

Adapteur mâle NPT - femelle fixe NPT



ROSCA (M) THREAD (M)	ROSCA (H) THREAD (F)	Referencia Part n°	€
1/8" NPT	1/8" NPT	ZN10600202	18,43
1/8" NPT	1/4" NPT	ZN10600204	23,74
1/4" NPT	1/8" NPT	ZN10600402	18,94
1/4" NPT	1/4" NPT	ZN10600404	15,38
1/4" NPT	3/8" NPT	ZN10600406	21,44
1/4" NPT	1/2" NPT	NEW ZN10600408	38,70
3/8" NPT	1/4" NPT	ZN10600604	22,96
3/8" NPT	3/8" NPT	ZN10600606	22,40
3/8" NPT	1/2" NPT	ZN10600608	24,72
1/2" NPT	3/8" NPT	ZN10600806	26,56
1/2" NPT	1/2" NPT	ZN10600808	28,18
1/2" NPT	3/4" NPT	ZN10600812	38,17
3/4" NPT	1/2" NPT	ZN10601208	31,56
3/4" NPT	3/4" NPT	ZN10601212	36,72
3/4" NPT	1" NPT	ZN10601216	44,17
1" NPT	3/4" NPT	ZN10601612	44,14
1" NPT	1" NPT	ZN10601616	44,09

Reducer male NPT - fixed female NPT

Reductor macho - hembra fija NPT

Reduzierstück m - w fest NPT

Réducteur mâle NPT - femelle fixe NPT



ROSCA (M) THREAD (M)	ROSCA (H) THREAD (F)	Referencia Part n°	€
3/8" NPT	1/8" NPT	ZN11500602	27,59
3/8" NPT	1" NPT	ZN11500604	23,65
1/2" NPT	1" NPT	ZN11500804	32,21
1/2" NPT	3/8" NPT	ZN11500806	27,08
3/4" NPT	1" NPT	ZN11501204	43,77
3/4" NPT	3/8" NPT	ZN11501206	56,71
3/4" NPT	1/2" NPT	ZN11501208	41,90
1" NPT	3/8" NPT	ZN11501606	69,67
1" NPT	1/2" NPT	ZN11501608	59,66
1" NPT	3/4" NPT	ZN11501612	51,13
1" 1/4 NPT	1" NPT	ZN11502016	93,88
1" 1/2 NPT	1" NPT	ZN11502416	168,90
1" 1/2 NPT	1" 1/4 NPT	ZN11502420	127,04

Adaptor male NPT - swivel female NPSM

Adaptador macho NPT - hembra giratoria NPSM

Adapter m NPT - w mit Drallmutter NPSM

Adapteur mâle NPT - femelle tournante NPSM



ROSCA (M) THREAD (M)	ROSCA (H) THREAD (F)	Referencia Part n°	€
1/8" NPT	1/8" NPSM	ZN11700202	20,75
1/4" NPT	1/4" NPSM	ZN11700404	22,75
3/8" NPT	3/8" NPSM	ZN11700606	29,04
3/8" NPT	1/2" NPSM	ZN11700608	37,64
1/2" NPT	1/2" NPSM	ZN11700808	52,08
1/2" NPT	3/4" NPSM	ZN11700812	57,10
3/4" NPT	3/4" NPSM	ZN11701212	50,40
3/4" NPT	1" NPSM	ZN11701216	76,72
1" NPT	1" NPSM	ZN11701616	78,92
1" 1/4 NPT	1" 1/4 NPSM	ZN11702020	165,28
1" 1/2 NPT	1" 1/2 NPSM	ZN11702424	144,30

Adaptor male UNF - swivel female NPSM

Adaptador macho UNF - hembra giratoria NPSM

Adapter m UNF - w mit Drallmutter NPSM

Adapteur mâle UNF - femelle tournante NPSM



ROSCA THREAD	Referencia Part n°	€	
7/16" - 20h UNF	1/4" - 18h NPSM	ZN11740404	54,23
9/16" - 18h UNF	3/8" - 18h NPSM	ZN11740606	59,18
9/16" - 18h UNF	1/2" - 14h NPSM	ZN11740608	79,62
3/4" - 16h UNF	1/2" - 14h NPSM	ZN11740808	73,60
3/4" - 16h UNF	3/4" - 14h NPSM	ZN11740812	114,81
7/8" - 14h UNF	1/2" - 14h NPSM	ZN11741008	87,45
7/8" - 14h UNF	3/4" - 14h NPSM	ZN11741012	116,40
1"1/16 - 12h UNF	3/4" - 14h NPSM	ZN11741212	128,15
1"5/16 - 12h UNF	1" - 11 1/2h NPSM	ZN11741616	156,36
1"5/8 - 12h UNF	1"1/4 - 11 1/2h NPSM	ZN11742020	250,93

NPT ADAPTORS

Adaptadores NPT
Adapter NPT
Adpteurs NPT

S.S. NPT fixed cap

Tapón hembra fija NPT

S.S. Verschlussstopfen HF NPT

Bouchon femelle fixe NPT



ROSCA THREAD	Referencia Part n°	€
1/8" NPT	ZN107202	13,39
1/4" NPT	ZN107204	15,87
3/8" NPT	ZN107206	18,74
1/2" NPT	ZN107208	22,20
3/4" NPT	ZN107212	28,60
1" NPT	ZN107216	34,34

S.S. NPT male plug

Tapón macho NPT

S.S. Verschluss TYP NPT

Bouchon mâle NPT



ROSCA THREAD	Referencia Part n°	€
1/8" NPT	ZN107002	6,13
1/4" NPT	ZN107004	9,02
3/8" NPT	ZN107006	12,23
1/2" NPT	ZN107008	12,87
3/4" NPT	ZN107012	15,16
1" NPT	ZN107016	26,92
1" 1/4 NPT	NEW ZN107020	46,92
1" 1/2 NPT	NEW ZN107024	74,63

S.S. NPT Allen plug

Tapón Allen NPT

S.S. Verschlussversch. Innensechskant NPT

Bouchon Allen NPT



ROSCA THREAD	Referencia Part n°	€
1/4" NPT	ZN107104	9,92
3/8" NPT	ZN107106	13,45
1/2" NPT	ZN107108	14,15
3/4" NPT	ZN107112	16,68
1" NPT	ZN107116	29,61

NPT hexagonal adaptor fixed female

Adaptador hexagonal hembra fija NPT

6 kt Doppelmuffe fest NPT

Adapteur hexagonal femelle fixe NPT



ROSCA THREAD	Referencia Part n°	€
1/8" NPT	ZN10310202	13,09
1/4" NPT	ZN10310404	16,30
3/8" NPT	ZN10310606	16,97
1/2" NPT	ZN10310808	20,46
3/4" NPT	ZN10311212	25,77
1" NPT	ZN10311616	41,12
1" 1/4 NPT	ZN10312020	87,88

NPT ADAPTORSAdaptadores NPT
Adapter NPT
Adaptateurs NPT**90° elbow male NPT - male NPT**

Codo 90° macho - macho NPT

90° Winkel m-m NPT

Coude 90° mâle NPT - mâle NPT



ROSCA THREAD		Referencia Part n°	€
1/8" NPT	1/8" NPT	ZN119002	18,82
1/4" NPT	1/4" NPT	ZN119004	21,84
3/8" NPT	3/8" NPT	ZN119006	30,06
1/2" NPT	1/2" NPT	ZN119008	38,93
3/4" NPT	3/4" NPT	ZN119012	66,24
1" NPT	1" NPT	ZN119016	87,88
1" 1/4 NPT	1" 1/4 NPT	NEW ZN119020	151,40

90° elbow male NPT - swivel female NPSM

Codo 90° macho NPT - hembra giratoria NPSM

90° Winkel m NPT - w mit Ü-Mutter NPSM

Coude 90° mâle NPT - femelle tournante NPSM



ROSCA THREAD		Referencia Part n°	€
1/8" NPT	1/8" 27h NPSM	ZN11930202	38,08
1/4" NPT	1/4" - 18h NPSM	ZN11930404	33,15
1/4" NPT	3/8" - 18h NPSM	ZN11930406	103,76
3/8" NPT	3/8" - 18h NPSM	ZN11930606	52,84
3/8" NPT	1/2" - 14h NPSM	ZN11930608	105,79
1/2" NPT	1/2" - 14 NPSM	ZN11930808	58,42
1/2" NPT	3/4" - 14h NPSM	ZN11930812	144,73
3/4" NPT	1/2" - 14 NPSM	ZN11931208	139,85
3/4" NPT	3/4" - 14h NPSM	ZN11931212	87,92
3/4" NPT	1" - 11 1/2 h NPSM	ZN11931216	345,64
1" NPT	1" - 11 1/2 h NPSM	ZN11931616	102,36
1" 1/4 NPT	1" 1/4 - 11 1/2 h NPSM	ZN11932020	159,61

90° elbow fixed female NPT - fixed female NPT

Codo 90° hembra fija - hembra fija NPT

90° Winkel w fest - w fest NPT

Coude 90° femelle fixe NPT - femelle fixe NPT



ROSCA THREAD		Referencia Part n°	€
1/8" NPT	1/8" NPT	ZN11960202	23,02
1/4" NPT	1/4" NPT	ZN11960404	31,84
3/8" NPT	3/8" NPT	ZN11960606	33,76
1/2" NPT	1/2" NPT	ZN11960808	54,91
3/4" NPT	3/4" NPT	ZN11961212	73,25
1" NPT	1" NPT	ZN11961616	132,09

45° elbow male NPT - male NPT

Codo 45° macho - macho NPT

45° Winkel m-m NPT

Coude 45° mâle NPT - mâle NPT



NEW

ROSCA THREAD		Referencia Part n°	€
1/4" NPT	1/4" NPT	ZN119804	*
3/8" NPT	3/8" NPT	ZN119806	*
1/2" NPT	1/2" NPT	ZN119808	*
3/4" NPT	3/4" NPT	ZN119812	*
1" NPT	1" NPT	ZN119816	*

45° elbow fixed female NPT - fixed female NPT

Codo 45° hembra fija- hembra fija NPT

45° Bogen w fest - w fest NPT

Coude 45° femelle fixe NPT - femelle fixe NPT



NEW

ROSCA THREAD		Referencia Part n°	€
1/4" NPT	1/4" NPT	ZN139604	*
3/8" NPT	3/8" NPT	ZN139606	*
1/2" NPT	1/2" NPT	ZN139608	*
3/4" NPT	3/4" NPT	ZN139612	*
1" NPT	1" NPT	ZN139616	*

45° elbow male NPT - swivel female NPSM

Codo 45° macho NPT - hembra giratoria NPSM

45° Bogen m NPT - w NPSM

Coude 45° mâle NPT - swivel female NPSM



ROSCA THREAD		Referencia Part n°	€
1/4" NPT	1/4" - 18h NPSM	ZN139304	95,70
3/8" NPT	3/8" - 18h NPSM	ZN139306	100,24
1/2" NPT	1/2" - 14h NPSM	ZN139308	123,72
1/4" NPT	3/4" - 14h NPSM	ZN139312	169,42
1" NPT	1" - 11 1/2 h NPSM	ZN139316	258,55

NPT ADAPTORS

Adaptadores NPT
Adapter NPT
Adpteurs NPT

NPT male tee

Tes macho-macho-macho NPT

T-Verschraubungen m - m - m NPT

Té mâle NPT



ROSCA THREAD			Referencia Part n°	€
1/8" NPT	1/8" NPT	1/8" NPT	ZN122002	27,55
1/4" NPT	1/4" NPT	1/4" NPT	ZN122004	44,11
3/8" NPT	3/8" NPT	3/8" NPT	ZN122006	51,88
1/2" NPT	1/2" NPT	1/2" NPT	ZN122008	59,29
3/4" NPT	3/4" NPT	3/4" NPT	ZN122012	82,71
1" NPT	1" NPT	1" NPT	ZN122016	155,83

NPT fixed female tee

Tes hembra fija-hembra fija-hembra fija NPT

T-Verschraubungen w fest NPT

Té femelle fixe NPT



ROSCA THREAD			Referencia Part n°	€
1/8" NPT	1/8" NPT	1/8" NPT	ZN122602	27,79
1/4" NPT	1/4" NPT	1/4" NPT	ZN122604	46,73
3/8" NPT	3/8" NPT	3/8" NPT	ZN122606	56,81
1/2" NPT	1/2" NPT	1/2" NPT	ZN122608	65,51
3/4" NPT	3/4" NPT	3/4" NPT	ZN122612	101,23
1" NPT	1" NPT	1" NPT	ZN122616	148,57

O'RING BOSS ADAPTORS

Adaptadores O'Ring Boss
Adapter O'Ring Boss
Adapteurs O'Ring Boss

Adaptor male - male O'Ring Boss

Adaptador macho - macho O'Ring Boss

Doppelnippel m - M O'Ring Boss

Adapteur mâle - mâle O'Ring Boss



TUBO PIPE	ROSCA THREAD	Referencia Part n°	€
6	1/4" 7/16"-20h UNF	ZS64640606	10,93
8	5/16" 1/2"-20h UNF	ZS64640808	10,55
10	3/8" 9/16"-18h UNF	ZS64641010	11,01
12	1/2" 3/4"-16h UNF	ZS64641212	18,74
14-15-16	5/8" 7/8"-14h UNF	ZS64641616	19,36
18-20	3/4" 1"1/16-12h UN	ZS64642020	27,40
25	1" 1"5/16-12h UN	ZS64642525	32,94

Adaptor male O'Ring Boss - male JIC 37°

Adaptador macho O'Ring Boss - macho JIC 37°

Doppelnippel m O'Ring Boss - m JIC 37°

Adapteur mâle O'Ring Boss- mâle JIC 37°



TUBO PIPE	ROSCA THREAD	Referencia Part n°	€
6	1/4" 7/16"-20h UNF	ZS22006	16,15
8	5/16" 1/2"-20h UNF	ZS22008	17,47
10	3/8" 9/16"-18h UNF	ZS22010	14,25
12	1/2" 3/4"-16h UNF	ZS22012	22,22
14-15-16	5/8" 7/8"-14h UNF	ZS22016	25,26
18-20	3/4" 1"1/16-12h UN	ZS22020	33,42
25	1" 1"5/16-12h UN	ZS22025	54,59
30-32	1" 1/4" 1"5/8-12h UN	ZS22032	90,19
38	1" 1/2" 1"7/8-12h UN	ZS22038	109,35

Adaptor male O'Ring Boss - adjustable male O'Ring Boss

Adaptador macho O'Ring Boss - macho regulable O'Ring Boss

Doppelnippel m O'Ring Boss - m einstellbar O'Ring Boss

Adapteur mâle O'Ring Boss - mâle réglable O'Ring Boss



TUBO PIPE	ROSCA THREAD	Referencia Part n°	€
6	1/4" 7/16"-20h UNF	ZS34740606	21,96
10	3/8" 9/16"-18h UNF	ZS34741010	29,96
12	1/2" 3/4"-16h UNF	ZS34741212	37,65
14-15-16	5/8" 7/8"-14h UNF	ZS34741616	49,37
18-20	3/4" 1"1/16-12h UN	ZS34742020	88,90
25	1" 1"5/16-12h UN	ZS34742525	125,50

Adaptor male O'Ring Boss - male NPT

Adaptador macho O'Ring Boss - macho NPT

Doppelnippel m O'Ring Boss - m NPT

Adapteur mâle O'Ring Boss- mâle NPT

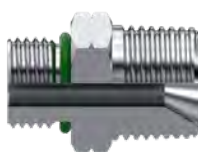

TUBO PIPE	ROSCA THREAD	Referencia Part n°	€
6	1/4" 7/16"-20h UNF	ZS64010613	10,82
10	3/8" 9/16"-18h UNF	ZS64011017	20,01
12	1/2" 3/4"-16h UNF	ZS64011221	21,84
14-15-16	5/8" 7/8"-14h UNF	ZS64011621	27,36
18-20	3/4" 1"1/16-12h UN	ZS64012026	31,56
25	1" 1"5/16-12h UN	ZS64012533	43,90

Adaptor male O'Ring Boss - swivel female JIC 37°

Adaptador macho O'Ring Boss - hembra giratoria JIC 37°

Adapter m O'Ring Boss - w mit Ü-Mutter metr. JIC 37°

Adapteur mâle O'Ring Boss - femelle tournante JIC 37°



TUBO PIPE	ROSCA (H) THREAD (F)	ROSCA (M) THREAD (M)	Referencia Part n°	€
6	1/4" 7/16" 20h UNF	7/16" 20h UNF	ZS38006	17,98
10	3/8" 9/16" 18h UNF	9/16" 18h UNF	ZS38010	24,43
12	1/2" 3/4" 16h UNF	3/4" 16h UNF	ZS38012	30,18
14-15-16	5/8" 7/8" 14h UNF	7/8" 14h UNF	ZS38016	32,87
18-20	3/4" 1"1/16 12h UN	1"1/16 12h UN	ZS38020	44,48
25	1" 1"5/16 12h UN	1"5/16 12h UN	ZS38025	63,45

Adaptor male O'Ring Boss - fixed female NPT

Prolongador macho O'Ring Boss - hembra fija NPT

Adapter m O'Ring Boss - w fest NPT

Prolongateur mâle O'Ring Boss - femelle fixe NPT



TUBO PIPE	ROSCA THREAD	Referencia Part n°	€
6	1/4" 7/16"-20h UNF	ZS64050613	26,29
10	3/8" 9/16"-18h UNF	ZS64051017	24,74
12	1/2" 3/4"-16h UNF	ZS64051221	42,35
14-15-16	5/8" 7/8"-14h UNF	ZS64051621	43,88
18-20	3/4" 1"1/16-12h UN	ZS64052026	55,51
25	1" 1"5/16-12h UN	ZS64052533	79,18

Male hexagonal O'Ring Boss plug

Tapón macho O'Ring Boss hexagonal

Verschlusschraube TYP O'Ring Boss 6 kt

Bouchon mâle O'Ring Boss hexagonal



ROSCA THREAD	Referencia Part n°	€
7/16" - 20h UNF	ZS640806	15,88
1/2" - 20h UNF	ZS640808	11,99
9/16" - 18h UNF	ZS640810	14,64
3/4" - 16h UNF	ZS640812	14,21
7/8" - 14h UNF	ZS640816	17,73
1"1/16 - 12h UN	ZS640820	24,41
1"5/16 - 12h UN	ZS640825	33,01

Male allen O'Ring Boss plug

Tapón macho O'Ring Boss Allen

Verschlusschraube TYP O'Ring Boss Innensechskant

Bouchon mâle O'Ring Boss allen



ROSCA THREAD	Referencia Part n°	€
7/16" - 20h UNF	ZS640906	10,85
1/2" - 20h UNF	ZS640908	14,68
9/16" - 18h UNF	ZS640910	14,93
3/4" - 16h UNF	ZS640912	17,20
7/8" - 14h UNF	ZS640916	18,55
1"1/16 - 12h UN	ZS640920	26,63
1"5/16 - 12h UN	ZS640925	34,28

O'RING BOSS ADAPTORS

Adaptadores O'Ring Boss
Adapter O'Ring Boss
Adapteurs O'Ring Boss

90° Adjustable elbow male O'Ring Boss -male JIC 37°

Codo 90° regulable macho O'Ring Boss - macho JIC 37°

90° Winkel einstellbar m O'Ring Boss - m JIC 37°

Coude 90° orientable mâle O'Ring Boss - mâle JIC 37°



TUBO PIPE	ROSCA THREAD		Referencia Part n°	€
6	1/4"	7/16" - 20h UNF	ZS57506	23,43
8	5/16"	1/2" - 20h UNF	ZS57508	25,93
10	3/8"	9/16" - 18h UNF	ZS57510	28,95
12	1/2"	3/4" - 16h UNF	ZS57512	47,34
14-15-16	5/8"	7/8" - 14h UNF	ZS57516	61,29
18-20	3/4"	1" 1/16 - 12h UN	ZS57520	90,10
25	1"	1" 5/16 - 12h UN	ZS57525	134,81

Adjustable Tee male O'Ring Boss - male JIC 37° - male JIC 37°

Te regulable macho O'Ring Boss - macho JIC 37° - macho JIC 37°

Einstellbare T-Einschraubungen O'Ring Boss - m JIC 37° - m JIC 37°

Té orientable macho O'Ring Boss - macho JIC 37° - macho JIC 37°



TUBO PIPE	ROSCA THREAD		Referencia Part n°	€
6	1/4"	7/16" - 20h UNF	ZS680306	*
8	5/16"	1/2" - 20h UNF	ZS680308	*
10	3/8"	9/16" - 18h UNF	ZS680310	*
12	1/2"	3/4" - 16h UNF	ZS680312	*
14-15-16	5/8"	7/8" 14h UNF	ZS680316	*
18-20	3/4"	1" 1/16-12h UN	ZS680320	*
25	1"	1" 5/16-12h UN	ZS680325	*

Adjustable Tee male JIC 37° - male O'Ring Boss - male JIC 37°

Te regulable macho JIC 37° - macho O'Ring Boss - macho JIC 37°

Einstellbare T-Einschraubungen m JIC 37° - O'Ring Boss - m JIC 37°

Té orientable macho JIC 37° - macho O'Ring Boss - macho JIC 37°



TUBO PIPE	ROSCA THREAD		Referencia Part n°	€
6	1/4"	7/16" - 20h UNF	ZS680406	*
8	5/16"	1/2" - 20h UNF	ZS680408	*
10	3/8"	9/16" - 18h UNF	ZS680410	*
12	1/2"	3/4" - 16h UNF	ZS680412	*
14-15-16	5/8"	7/8" 14h UNF	ZS680416	*
18-20	3/4"	1" 1/16-12h UN	ZS680420	*
25	1"	1" 5/16-12h UN	ZS680425	*

ORFS ADAPTORS

Adaptadores ORFS
Adapter ORFS
Adpteurs ORFS

ORFS Nut

Tuerca ORFS

Mutter ORFS - m ORFS

Écrou ORFS



TUBO PIPE	ROSCA THREAD	Referencia Part n°	€
6-8	ORFS 9/16"-18h	ZOR1020400	12,09
10	ORFS 11/16"-16h	ZOR1020600	11,80
12	ORFS 13/16"-16h	ZOR1020800	13,21
14-15-16	ORFS 1"-14h	ZOR1021000	20,18
18-20	ORFS 1 3/16-12h	ZOR1021200	19,20
22-25	ORFS 1 7/16-12h	ZOR1021600	25,01
28-30-32	ORFS 1 11/16-12h	ZOR1022000	48,32
35-38	ORFS 2"-12h	ZOR1022400	56,99

ORFS Welding nipple

Cono soldar ORFS

Schweißkegel ORFS

Collet à souder ORFS



TUBO PIPE	ROSCA THREAD	Referencia Part n°	€
6	ORFS 9/16"-18h	ZOR12730406	9,03
8	ORFS 9/16"-18h	ZOR12730408	9,86
10	ORFS 11/16"-16h	ZOR12730610	10,02
12	ORFS 13/16"-16h	ZOR12730812	10,73
14	ORFS 1"-14h	ZOR12731014	18,01
15	ORFS 1"-14h	ZOR12731015	13,54
16	ORFS 1"-14h	ZOR12731016	13,77
18	ORFS 1 3/16-12h	ZOR12731218	23,04
20	ORFS 1 3/16-12h	ZOR12731220	23,04
22	ORFS 1 7/16-12h	ZOR12731622	32,62
30	ORFS 1 11/16-12h	ZOR12732030	41,26
32	ORFS 1 11/16-12h	ZOR12732032	41,26
38	ORFS 2"-12h	ZOR12732438	74,96

ORFS Male plug

Tapón macho ORFS

Verschlusschraube TYP ORFS

Bouchon mâle ORFS



ROSCA THREAD	Referencia Part n°	€
ORFS 9/16"-18h	ZOR1040400	10,49
ORFS 11/16"-16h	ZOR1040600	14,07
ORFS 13/16"-16h	ZOR1040800	14,32
ORFS 1"-14h	ZOR1041000	26,98
ORFS 1 3/16-12h	ZOR1041200	26,51
ORFS 1 7/16-12h	ZOR1041600	43,91
ORFS 1 11/16-12h	ZOR1042000	56,14
ORFS 2"-12h	ZOR1042400	69,91

ORFS cap

Tapón hembra ORFS

Verschluss ORFS

Bouchon femelle ORFS



ROSCA THREAD	Referencia Part n°	€
ORFS 9/16"-18h	ZOR1050400	17,12
ORFS 11/16"-16h	ZOR1050600	18,09
ORFS 13/16"-16h	ZOR1050800	21,80
ORFS 1"-14h	ZOR1051000	28,68
ORFS 1 3/16-12h	ZOR1051200	43,06
ORFS 1 7/16-12h	ZOR1051600	52,57
ORFS 1 11/16-12h	ZOR1052000	68,92
ORFS 2"-12h	ZOR1052400	91,41

ORFS Male adaptor

Adaptador macho-macho ORFS

Doppelnippel m - m ORFS

Adapteur mâle ORFS



ROSCA THREAD	ROSCA THREAD	Referencia Part n°	€
ORFS 9/16"-18h	ORFS 9/16"-18h	ZOR2000404	23,55
ORFS 11/16"-16h	ORFS 11/16"-16h	ZOR2000606	23,94
ORFS 13/16"-16h	ORFS 13/16"-16h	ZOR2000808	29,21
ORFS 1"-14h	ORFS 1"-14h	ZOR2001010	41,84
ORFS 1 3/16-12h	ORFS 1 3/16-12h	ZOR2001212	33,83
ORFS 1 7/16-12h	ORFS 1 7/16-12h	ZOR2001616	52,28
ORFS 1 11/16-12h	ORFS 1 11/16-12h	ZOR2002020	70,80
ORFS 2"-12h	ORFS 2"-12h	ZOR2002424	96,56

ORFS Male - BSP Male

Adaptador macho ORFS-macho BSP

Doppelnippel m ORFS - m BSP

Adapteur mâle ORFS - mâle BSP



ROSCA THREAD	ROSCA THREAD	Referencia Part n°	€
ORFS 9/16"-18h	BSP 1/4"	ZOR2020404	22,82
ORFS 11/16"-16h	BSP 3/8"	ZOR2020606	22,89
ORFS 13/16"-16h	BSP 1/2"	ZOR2020808	32,73
ORFS 1 3/16-12h	BSP 3/4"	ZOR2021212	45,87
ORFS 1 7/16-12h	BSP 1"	ZOR2021616	56,70
ORFS 1 7/16-12h	BSP 1" 1/4	ZOR2021620	97,81
ORFS 1 11/16-12h	BSP 1" 1/4	ZOR2022020	95,78
ORFS 2"-12h	BSP 1" 1/2	ZOR2022424	134,96

ORFS ADAPTORS

Adaptadores ORFS
Adapter ORFS
Adapteurs ORFS

ORFS Male - Metric Male

Adaptador macho ORFS-macho Métrico

Doppelnippel m ORFS-m metr.

Adapteur mâle ORFS - mâle Métrique

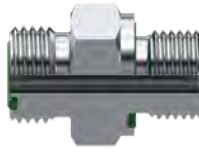

ROSCA THREAD		Referencia Part n°	€
ORFS 9/16"-18h	M12x1.5	ZOR10170412	24,62
ORFS 11/16"-16h	M16x1.5	ZOR10170616	25,03
ORFS 13/16"-16h	M18x1.5	ZOR10170818	36,36
ORFS 1"-14h	M22x1.5	ZOR10171022	48,99
ORFS 1"7/16-12h	M33x2	ZOR10171633	62,99
ORFS 1"11/16-12h	M42x2	ZOR10172042	102,32
ORFS 2"-12h	M48x2	ZOR10172448	149,96

ORFS Bulkhead

Pasatabiques ORFS

Schottverschraubungen ORFS SV- ORFS

Passe-cloison ORFS



ROSCA THREAD	Referencia Part n°	€
ORFS 9/16"-18h	ZOR1060404	42,65
ORFS 11/16"-16h	ZOR1060606	42,20
ORFS 13/16"-16h	ZOR1060808	53,65
ORFS 1"-14h	ZOR1061010	90,16
ORFS 1"3/16-12h	ZOR1061212	103,87
ORFS 1"7/16-12h	ZOR1061616	124,60
ORFS 1"11/16-12h	ZOR1062020	145,81
ORFS 2"-12h	ZOR1062424	182,47

ORFS Male - ORFS Swivel female

Adaptador macho-hembra giratoria ORFS

Adapter m O'Ring Boss - w mit Ü-Mutter ORFS

Adapteur mâle - femelle tournante ORFS



ROSCA (H) THREAD (F)	ROSCA (M) THREAD (M)	Referencia Part n°	€
ORFS 9/16"-18h	ORFS 11/16"-16h	ZOR3010406	25,44
ORFS 11/16"-16h	ORFS 9/16"-18h	ZOR3010604	27,66
ORFS 13/16"-16h	ORFS 9/16"-18h	ZOR3010804	31,25
ORFS 13/16"-16h	ORFS 11/16"-16h	ZOR3010806	28,64
ORFS 1"-14h	ORFS 9/16"18h	ZOR3011004	40,60
ORFS 1"-14h	ORFS 11/16"16h	ZOR3011006	39,80
ORFS 1"-14h	ORFS 13/16"-16h	ZOR3011008	37,86
ORFS 1"3/16-12h	ORFS 11/16"-16h	ZOR3011206	70,05
ORFS 1"3/16-12h	ORFS 13/16-16h	ZOR3011208	68,50
ORFS 1"3/16-12h	ORFS 1"-14h	ZOR3011210	63,32
ORFS 1"7/16-12h	ORFS 13/16"-16h	ZOR3011608	77,32
ORFS 1"7/16-12h	ORFS 1"-14h	ZOR3011610	74,99
ORFS 1"7/16-12h	ORFS 1"3/16-12h	NEW ZOR3011612	73,85
ORFS 1"11/16-12h	ORFS 1"3/16-12h	ZOR3012012	71,24
ORFS 1"11/16-12h	ORFS 1"7/16-12h	ZOR3012016	100,13

ORFS Male - 37° JIC Male

Adaptador macho ORFS-macho JIC 37°

Doppelnippel m ORFS-m JIC 37°

Adapteur mâle ORFS - mâle JIC 37°



ROSCA THREAD		Referencia Part n°	€
ORFS 9/16"-18h	JIC 7/16"	ZOR2040404	17,48
ORFS 11/16"-16h	JIC 9/16"	ZOR2040606	24,54
ORFS 13/16"-16h	JIC 3/4"	ZOR2040808	24,01
ORFS 1"-14h	JIC 7/8"	ZOR2041010	24,22
ORFS 1"3/16-12h	JIC 1"1/16	ZOR2041212	31,76
ORFS 1"7/16-12h	JIC 1"5/16	ZOR2041616	49,77
ORFS 1"11/16"-12h	JIC 1"5/8	ZOR2042020	72,84
ORFS 2"-12h	JIC 1"7/8	ZOR2042424	104,28

ORFS Male - 37° JIC Swivel female

Adaptador macho ORFS-hembra giratoria JIC 37°

Adapter m ORFS - w mit Ü-Mutter JIC 37°

Adapteur mâle ORFS - femelle tournante JIC 37°



ROSCA THREAD		Referencia Part n°	€
ORFS 9/16"-18h	JIC 7/16"	ZOR3020404	21,89
ORFS 11/16"-16h	JIC 9/16"	ZOR3020606	29,75
ORFS 13/16"-16h	JIC 3/4"	ZOR3020808	25,97
ORFS 1"-14h	JIC 7/8"	ZOR3021010	33,95
ORFS 1"3/16-12h	JIC 1"1/16	ZOR3021212	41,92
ORFS 1"7/16-12h	JIC 1"5/16	ZOR3021616	56,66
ORFS 1"11/16-12h	JIC 1"5/8	ZOR3022020	71,26
ORFS 2"-12h	JIC 1"7/8	ZOR3022424	83,65

JIC Male - ORFS Swivel female

Adaptador macho JIC 37°-hembra giratoria ORFS

JIC m - w mit Ü-Mutter ORFS

Adapteur mâle JIC 37° - femelle tournante ORFS



ROSCA THREAD		Referencia Part n°	€
JIC 7/16"	ORFS 9/16"-18 h	ZOR3050404	23,56
JIC 9/16"	ORFS 11/16"-16h	ZOR3050606	27,49
JIC 3/4"	ORFS 13/16"-16 h	ZOR3050808	33,14
JIC 7/8"	ORFS 1"-14h	ZOR3051010	37,23
JIC 1"1/16	ORFS 1"3/16-12 h	ZOR3051212	51,79
JIC 1"5/16	ORFS 1"7/16-12 h	ZOR3051616	74,68
JIC 1"5/8	ORFS 1"11/16"-12h	ZOR3052020	90,19
JIC 1"7/8"	ORFS 2"-12h	ZOR3052424	90,27

ORFS ADAPTORS

Adaptadores ORFS
Adapter ORFS
Adpteurs ORFS

90° ORFS male - ORFS male

Codo 90° macho-macho ORFS

90° Winkel m - m ORFS

Coude 90° mâle ORFS - mâle ORFS



ROSCA THREAD	ROSCA THREAD	Referencia Part n°	€
ORFS 9/16"-18h	ORFS 9/16"-18h	ZOR4050404	35,33
ORFS 11/16"-16h	ORFS 11/16"-16h	ZOR4050606	47,19
ORFS 13/16"-16h	ORFS 13/16"-16h	ZOR4050808	58,01
ORFS 1"-14h	ORFS 1"-14h	ZOR4051010	64,59
ORFS 1"3/16-12h	ORFS 1"3/16-12h	ZOR4051212	74,30
ORFS 1"7/16-12h	ORFS 1"7/16-12h	ZOR4051616	103,58
ORFS 1"11/16-12h	ORFS 1"11/16-12h	ZOR4052020	157,39
ORFS 2"-12h	ORFS 2"-12h	ZOR4052424	194,96

90° ORFS swivel female - ORFS male

Codo 90° macho-hembra giratoria ORFS

90° Winkel m - w mit Ü-Mutter ORFS

Coude 90° femelle tournante ORFS- mâle ORFS



ROSCA (M) THREAD (M)	ROSCA (H) THREAD (F)	Referencia Part n°	€
ORFS 9/16"-18h	ORFS 9/16"-18h	ZOR6000404	50,97
ORFS 11/16"-16h	ORFS 11/16"-16h	ZOR6000606	63,73
ORFS 13/16"-16h	ORFS 13/16"-16h	ZOR6000808	83,39
ORFS 1"-14h	ORFS 1"-14h	ZOR6001010	89,94
ORFS 1"3/16-12h	ORFS 1"3/16-12h	ZOR6001212	111,28
ORFS 1"7/16-12h	ORFS 1"7/16-12h	ZOR6001616	126,82
ORFS 1"11/16-12h	ORFS 1"11/16-12h	ZOR6002020	155,90

ORFS Male Tee

Te macho-macho-macho ORFS

T-Verschraubung m-m-m - ORFS

Té Mâle ORFS



ROSCA THREAD	Referencia Part n°	€
ORFS 9/16"18h	ZOR7000404	45,50
ORFS 11/16"-16h	ZOR7000606	48,09
ORFS 13/16"-16h	ZOR7000808	60,26
ORFS 1"-14h	ZOR7001010	70,26
ORFS 1"3/16-12h	ZOR7001212	91,47
ORFS 1"7/16-12h	ZOR7001616	137,18
ORFS 1"11/16-12h	ZOR7002020	175,34
ORFS 2"-12h	ZOR7002424	252,28

ORFS Male-Swivel female-Male Tee

Te macho-hembra giratoria-macho ORFS

T-Verschraubungen ORFS m - w Ü-Mutter - m

Té Mâle-Femelle tournante-Mâle ORFS



ROSCA THREAD	Referencia Part n°	€
ORFS 9/16"-18h	ZOR7010404	74,20
ORFS 11/16"-16h	ZOR7010606	75,86
ORFS 13/16"-16h	ZOR7010808	83,28
ORFS 1"-14h	ZOR7011010	119,72
ORFS 1"3/16-12h	ZOR7011212	144,10
ORFS 1"7/16-12h	ZOR7011616	194,64
ORFS 1"11/16-12h	ZOR7012020	226,83
ORFS 2"-12h	ZOR7012424	284,43

ORFS Male-Male-Swivel Female Tee

Te macho-macho-hembra giratoria ORFS

T-Verschraubungen m - m - w mit Ü-Mutter ORFS

Té Mâle-Mâle-Femelle tournante ORFS



ROSCA THREAD	Referencia Part n°	€
ORFS 9/16"-18h	ZOR7020404	74,20
ORFS 11/16"-16h	ZOR7020606	78,89
ORFS 13/16"-16h	ZOR7020808	86,61
ORFS 1"-14h	ZOR7021010	119,72
ORFS 1"3/16-12h	ZOR7021212	158,26
ORFS 1"7/16-12h	ZOR7021616	194,64
ORFS 1" 11/16-12h	ZOR7022020	220,65

O'ring FKM green for ORFS thread

Juntas tóricas FKM verde para rosca ORFS

O-Ringe FKM grün für ORFS

Joint torique FKM vert pour filetage ORFS



ROSCA THREAD	Referencia Part n°	€
ORFS 9/16"-18h	JVORFS04	0,49
ORFS 11/16"-16h	JVORFS06	0,54
ORFS 13/16"-16h	JVORFS08	0,61
ORFS 1"-14h	JVORFS10	0,68
ORFS 1"3/16-12h	JVORFS12	0,92
ORFS 1"7/16-12h	JVORFS16	1,44
ORFS 1" 11/16-12h	JVORFS20	1,81
ORFS 2"-12h	JVORFS24	2,15

Fabricamos pensando en ti

La calidad de los artículos de DICSA es controlada con la más avanzada tecnología

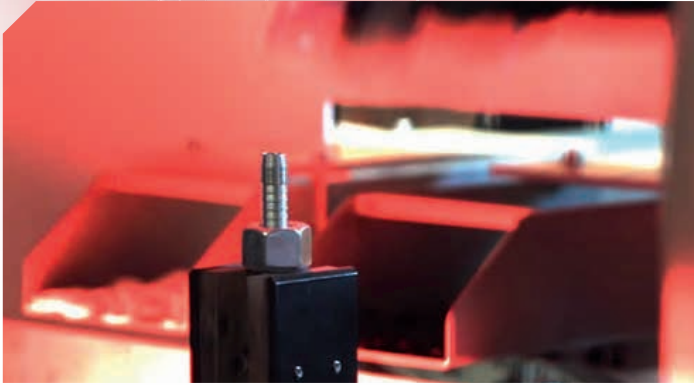

Alta rapidez de mecanizado
High speed machining



Máquina Transfer de alta productividad
Highly productivity Transfer machine



Tornos tipo suizo CNC
CNC Swiss Type Automatic Lathes



Curvadora automática
Automatic bending machine

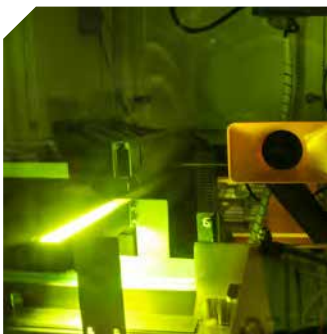

Marcadora láser
Laser marking



Máquina semi-automática de montaje
Semi-automatic fitting machine



CNC Robotizado
CNC Machine



Máquina de corte computarizada
Computerized Cutter Machine

We can be your Manufacturing Partners

The quality and uniformity of DICSA's products are controlled by the most innovative technology

WELDING FITTINGS | 199

Racores soldables
Schweißverschraubungen
Embouts à souder

WELDING FLANGES | 207

Bridas soldables
Schweißflansche
Brides à souder

05

WELDING FITTINGS

Racores soldables
Schweißverschraubungen
Embouts à souder



WELDING FITTINGSRacores soldables
Schweißverschraubungen
Embouts à souder

Welding Male ▪ Racores macho para soldar ▪ Schweißversch. m ▪ Raccords mâle à souder

| 199



81070

Z1035

Z10351

Z1033

Z1290

Z1032

Z1034

Welding BSP nuts ▪ Racores BSP para soldar ▪ Schweißarmaturen BSP ▪ Écrous tournants à souder

| 200



Z1281

Z1037

Z1038

Z1282

Z1039

Z1040

Welding JIC fittings ▪ Racores JIC para soldar ▪ Schweißversch. JIC ▪ Raccords JIC à souder

| 201



Z1283

Z1036

Z1041

Z1042

Welding metric fittings ▪ Racores Métricos para soldar ▪ Metr. Schweißversch. ▪ Raccords métriques à souder

| 202



Z1051

ZCMORIL/5

KZL00

KZC90

KZC45

Z1052

Z1054

Z1053

Z1055

Welding fittings >2" ▪ BSP >2" ▪ Schweißnippel >2" ▪ Raccords à souder >2"

| 204



Z1270

ZM1032

ZM1032

Other welding BSP fittings ▪ Conos ajuste BSP ▪ Andere Schweißversch. BSP ▪ Autres raccords à souder BSP

| 205



Z1270

Z1273

Z1274

Other welding JIC fittings ▪ Conos ajuste JIC ▪ Andere Schweißversch. JIC ▪ Autres raccords à souder JIC

| 205



Z1277

ZS110

Welding fittings microcast ▪ Racores Microfundido para soldar ▪ Schweißversch. Mikroguss ▪ Raccords à souder micro-moulés

| 206



ZFIG340...HS

ZFIG340...S

ZFIG341...MS

WELDING FLANGES

Bridas soldables
Schweißflansche
Brides à souder

Fixed Forged flanges ▪ Bridas fijas para soldar ▪ Vorschweißflansche ▪ Brides DIN à souder fixes

207



ZBPN162633

ZBPN402635

ZBANSAWN150

ZBANSAWN300

DIN 2642 swivel flanges set ▪ Conjunto bridas DIN 2642 ▪ Flanschsatz DIN 2642 ▪ Ensemble brides tournantes
DIN 2642

208



ZBPN102642

ZABAR02642

ZBTUBO

DIN 2656 swivel flanges set ▪ Conjunto bridas DIN 2656 ▪ Flanschsatz DIN 2656 ▪ Ensemble brides tournantes
DIN 2656

209



ZBPN402656

ZABAR02656

ZBTUBO

ANSI-ASA swivel flanges set ▪ Conjunto bridas ANSI-ASA ▪ Flanschsatz ANSI-ASA ▪ Ensemble brides ANSI-ASA

210



ZBANSAS0150

ZBANSAS0300

ZABAROANSA

ZBTUBO

CONSULTA EL
CATÁLOGO DE
CONDUCCIONES

REQUEST ON
CATALOGUE
CONNECTORS



www.dicsaes.com

MANGUERAS ACERO INOXIDABLE STAINLESS STEEL HOSES

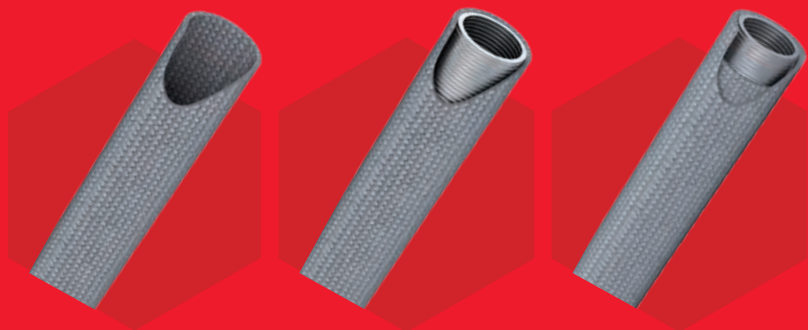

Mangueras de inoxidable corrugado para instalaciones en el sector químico, centrales eléctricas y plantas petroquímicas.

Convolutated stainless steel hoses for a variety of facilities, such us chemical sector, power plant, oil and gas.

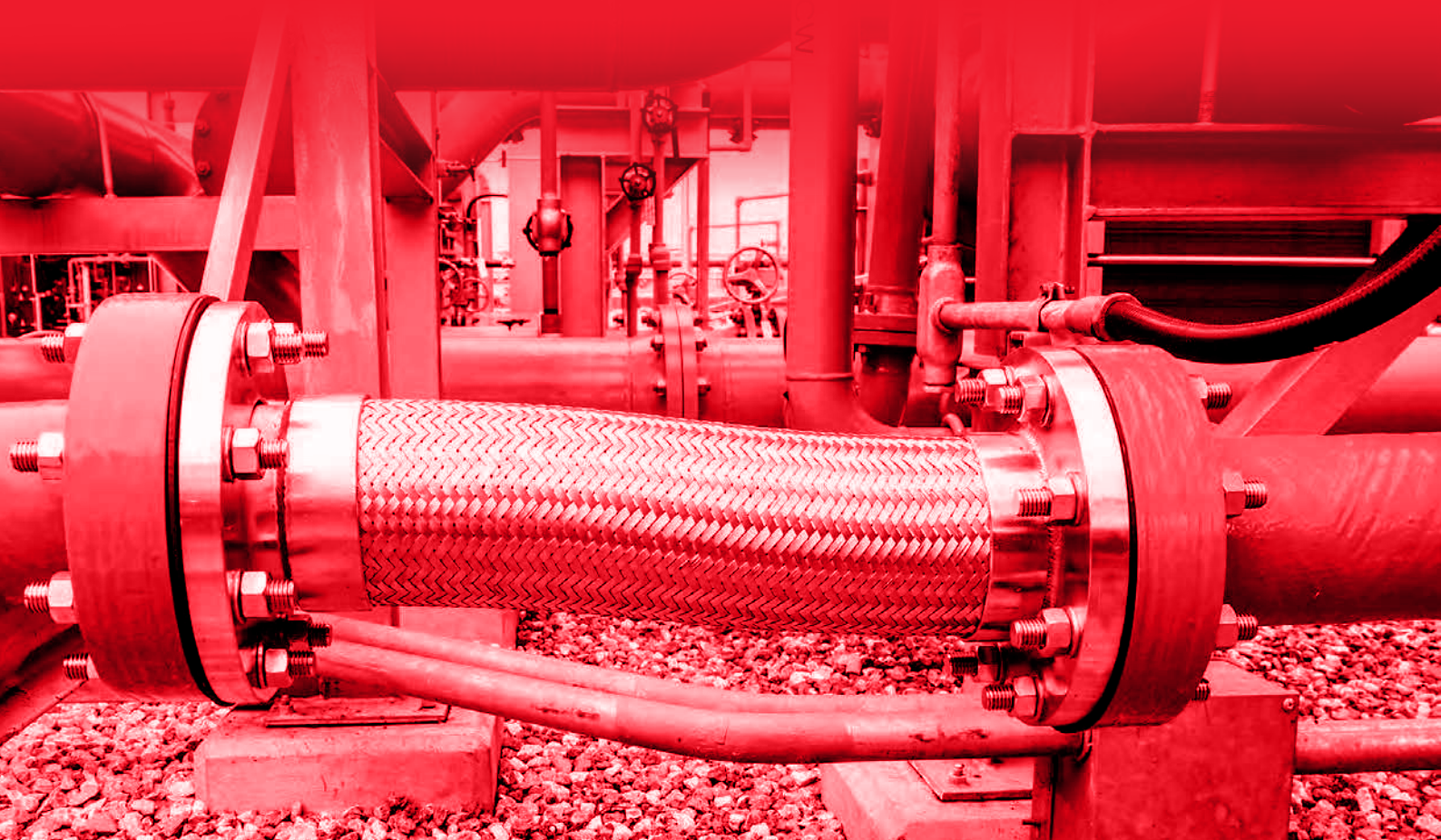

WELDING FITTINGS

Racores soldables
Schweißverschraubungen
Embouts à souder

Welding ferrule

Casquillo soldable

Pressfassungen für Ringwellschläuche

Jupe à souder



DN	Ø INT. Ø INNER	Referencia Part n°	€
1/4"	14	810700400	1,67
1/4"	12	810700401	1,80
3/8"	19	810700600	2,60
3/8"	17	810700601	1,91
1/2"	22	810700800	2,44
1/2"	19	810700801	2,44
5/8"	25	810701000	2,83
3/4"	30	810701200	3,01
3/4"	32	810701201	3,30
1"	35	810701500	3,45
1"	37	810701600	5,56
1 1/4"	47,8	810702000	6,33
1 1/4"	44,3	810702001	6,13
1 1/2"	56,3	810702400	7,41
2"	66	810703201	11,54
2 1/2"	84,9	810704000	15,48
2 1/2"	95,6	810704001	23,17
3"	100	810704801	27,05
4"	125	810706400	35,86

Welding BSP 60° Male with guide

Macho soldable BSP cono 60° con guía

Schweiß-Außengewinde BSP mit AG

Mâle gaz BSP 60° à souder avec guide



ROSCA THREAD	DN	Referencia Part n°	€
1/4" BSP	1/4"	Z103504	13,98
3/8" BSP	3/8"	Z103506	14,08
1/2" BSP	1/2"	Z103508	12,96
3/4" BSP	3/4"	Z103512	18,39
1" BSP	1"	Z103516	33,00
1 1/4" BSP	1 1/4"	Z103520	54,30
1 1/2" BSP	1 1/2"	Z103524	68,25
2" BSP	2"	Z103532	85,36

Inside welding BSP Male

Macho BSP 60° soldable interior

Außengewinde BSP 60° innen schweißbar

Mâle à souder int. BSP



ROSCA THREAD	DN	Referencia Part n°	€
1/4" BSP	1/4"	Z1035104	14,79
3/8" BSP	3/8"	Z1035106	18,93
1/2" BSP	1/2"	Z1035108	20,34
3/4" BSP	3/4"	Z1035112	22,74
1" BSP	1"	Z1035116	32,66
1 1/4" BSP	1 1/4"	Z1035120	53,56
1 1/2" BSP	1 1/2"	Z1035124	62,07
2" BSP	2"	Z1035132	90,57

Welding BSP Male flat seat with guide

Macho soldable BSP asiento plano con guía

Schweiß-Außengewinde flachdichtend BSP

Mâle gaz BSP fond plat à souder avec guide



ROSCA THREAD	DN	Referencia Part n°	€
1/4" BSP	1/4"	Z103304	13,48
3/8" BSP	3/8"	Z103306	21,57
1/2" BSP	1/2"	Z103308	16,50
3/4" BSP	3/4"	Z103312	21,88
1" BSP	1"	Z103316	34,13
1 1/4" BSP	1 1/4"	Z103320	56,54
1 1/2" BSP	1 1/2"	Z103324	72,27
2" BSP	2"	Z103332	95,81

Welding male BSP 60° union

Empalme liso soldable macho BSP 60°

Anschweißnippel BSP 60°

Embout mâle lisse à souder BSP cône 60°



ROSCA THREAD	DN	Referencia Part n°	€
1/8" BSP	1/8"	Z129002	7,65
1/4" BSP	1/4"	Z129004	7,78
3/8" BSP	3/8"	Z129006	7,96
1/2" BSP	1/2"	Z129008	8,76
3/4" BSP	3/4"	Z129012	19,63
1" BSP	1"	Z129016	26,00
1 1/4" BSP	1 1/4"	Z129020	33,48
1 1/2" BSP	1 1/2"	Z129024	48,53
2" BSP	2"	Z129032	109,72

Welding BSPT Male 60° with guide

Macho soldable BSPT cono 60° con guía

Schweiß-Außengewinde BSPT mit AG

Mâle gaz conique à souder 60° avec guide



ROSCA THREAD	DN	Referencia Part n°	€
1/4" BSPT	1/4"	Z103204	12,72
3/8" BSPT	3/8"	Z103206	15,76
1/2" BSPT	1/2"	Z103208	13,76
3/4" BSPT	3/4"	Z103212	19,49
1" BSPT	1"	Z103216	30,22
1 1/4" BSPT	1 1/4"	Z103220	49,91
1 1/2" BSPT	1 1/2"	Z103224	61,83
2" BSPT	2"	Z103232	91,95

WELDING FITTINGS

Racores soldables
Schweißverschraubungen
Embouts à souder

Welding NPT Male 60° with guide

Macho soldable NPT cono 60° con guía

Schweiß-Außengewinde NPT mit AG

Mâle NPT à souder 60° avec guide

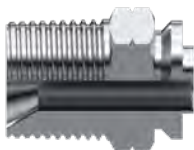

ROSCA THREAD	DN		Referencia Part n°	€
1/8" NPT	1/4"	NEW	Z10340204	21,44
1/4" NPT	1/4"		Z10340400	11,22
3/8" NPT	3/8"		Z10340600	14,49
1/2" NPT	1/2"		Z10340800	16,61
3/4" NPT	3/4"		Z10341200	20,78
1" NPT	1"		Z10341600	31,14
1"1/4 NPT	1"1/4		Z10342000	50,69
1"1/2 NPT	1"1/2		Z10342400	57,42
2" NPT	2"		Z10343200	101,67

Welding BSP 60° swept with guide

Hembra giratoria prensada soldable BSP 60° con guía

Schweiß-Dichtkopf mit Ü-Mutter BSP mit AG

Femelle tournante BSP 60° à souder avec guide



ROSCA THREAD	DN		Referencia Part n°	€
1/4" BSP	1/4"		Z128104	12,52
3/8" BSP	3/8"		Z128106	12,91
1/2" BSP	1/2"		Z128108	16,45
3/4" BSP	3/4"		Z128112	21,31
1" BSP	1"		Z128116	30,40
1"1/4 BSP	1"1/4		Z128120	61,12
1"1/2 BSP	1"1/2		Z128124	71,28
2" BSP	2"		Z128132	115,88

Welding BSP 60° swept 90°

Hembra giratoria 90° prensada soldable BSP 60°

Schweiß-Dichtkopf 90° mit Ü-Mutter BSP 60°

Femelle tournante à souder 90° BSP cône 60°



ROSCA THREAD	DN		Referencia Part n°	€
1/4" BSP	1/4"		Z103704	27,45
3/8" BSP	3/8"		Z103706	32,34
1/2" BSP	1/2"		Z103708	38,17
3/4" BSP	3/4"		Z103712	56,45
1" BSP	1"		Z103716	69,71
1"1/4 BSP	1"1/4		Z103720	112,88
1"1/2 BSP	1"1/2		Z103724	149,09
2" BSP	2"		Z103732	157,78

Welding BSP 60° swept 45°

Hembra giratoria 45° prensada soldable BSP 60°

Schweiß-Dichtkopf 45° mit Ü-Mutter BSP 60°

Femelle tournante à souder 45° BSP cône 60°



ROSCA THREAD	DN		Referencia Part n°	€
1/4" BSP	1/4"		Z103804	27,80
3/8" BSP	3/8"		Z103806	33,22
1/2" BSP	1/2"		Z103808	41,76
3/4" BSP	3/4"		Z103812	49,22
1" BSP	1"		Z103816	66,96
1"1/4 BSP	1"1/4		Z103820	119,13
1"1/2 BSP	1"1/2		Z103824	127,73
2" BSP	2"		Z103832	155,52

Welding BSP flat seat swept with guide

Hembra giratoria prensada soldable BSP asiento plano con guía

Schweiß-Dichtkopf BSP flachdichtend

Femelle tournante BSP fond plat à souder avec guide



ROSCA THREAD	DN		Referencia Part n°	€
1/4" BSP	1/4"		Z128204	10,84
3/8" BSP	3/8"		Z128206	13,58
1/2" BSP	1/2"		Z128208	15,05
3/4" BSP	3/4"		Z128212	18,09
1" BSP	1"		Z128216	27,59
1"1/4 BSP	1"1/4		Z128220	58,53
1"1/2 BSP	1"1/2		Z128224	80,56
2" BSP	2"		Z128232	116,74

Welding BSP Female 90° flat seat swept

Hembra giratoria 90° prensada soldable BSP asiento plano

Schweiß-Dichtkopf 90° BSP flachdichtend

Femelle tournante à souder 90° BSP fond plat



ROSCA THREAD	DN		Referencia Part n°	€
1/4" BSP	1/4"		Z103904	34,83
3/8" BSP	3/8"		Z103906	40,90
1/2" BSP	1/2"		Z103908	34,30
3/4" BSP	3/4"		Z103912	56,28
1" BSP	1"		Z103916	66,91
1"1/4 BSP	1"1/4		Z103920	149,28
1"1/2 BSP	1"1/2		Z103924	154,72
2" BSP	2"		Z103932	166,88

WELDING FITTINGS

Racores soldables
Schweißverschraubungen
Embouts à souder

Welding BSP Female 45° flat seat swept

Hembra giratoria 45° prensada soldable BSP
asiento plano
Schweiß-Dichtkopf 45° mit Ü-Mutter BSP
flachdichtend

Femelle tournante à souder 45° BSP fond plat



ROSCA THREAD	DN	Referencia Part n°	€
1/4" BSP	1/4"	Z104004	24,51
3/8" BSP	3/8"	Z104006	25,34
1/2" BSP	1/2"	Z104008	34,92
3/4" BSP	3/4"	Z104012	49,55
1" BSP	1"	Z104016	60,97
1"1/4 BSP	1"1/4	Z104020	90,37
1"1/2 BSP	1"1/2	Z104024	140,50
2" BSP	2"	Z104032	164,28

Welding 90° JIC Female 37° swept

Hembra giratoria 90° prensada soldable JIC 37°
Schweiß-Dichtkopf 90° mit Ü-Mutter JIC 37°

Femelle tournante à souder 90° JIC 37°



ROSCA THREAD	DN	Referencia Part n°	€
7/16" 20h UNF	1/4"	Z10410704	24,66
1/2" 20h UNF	1/4"	Z10410804	24,19
9/16" 18h UNF	3/8"	Z10410906	27,42
3/4" 16h UNF	1/2"	Z10411208	34,02
7/8" 14h UNF	1/2"	Z10411408	34,50
1"1/16 12h UN	3/4"	Z10411712	54,12
1"5/16 12h UN	1"	Z10412116	64,79
1"5/8 12h UN	1"1/4	Z10412620	103,54
1"7/8 12h UN	1"1/2	Z10413024	175,53

Welding JIC female 37° swept with guide

Hembra giratoria prensada soldable JIC 37° con guía

Schweiß-Dichtkopf mit Ü-Mutter JIC 37° mit AG

Femelle tournante JIC 37° à souder avec guide



ROSCA THREAD	DN	Referencia Part n°	€
7/16" 20h UNF	1/4"	Z12830704	19,31
1/2" 20h UNF	1/4"	Z12830804	15,53
9/16" 18h UNF	3/8"	Z12830906	15,97
3/4" 16h UNF	3/8"	Z12831206	17,74
3/4" 16h UNF	1/2"	Z12831208	17,15
7/8" 14h UNF	1/2"	Z12831408	18,82
1"1/16 12h UN	3/4"	Z12831712	22,63
1"5/16 12h UN	1"	Z12832116	31,30
1"5/8 12h UN	1"1/4	Z12832620	59,19
1"7/8 12h UN	1"1/2	Z12833024	87,71

Welding 45° JIC Female 37° swept

Hembra giratoria 45° prensada soldable JIC 37°

Schweiß-Dichtkopf 45° mit Ü-Mutter JIC 37°

Femelle tournante à souder 45° JIC 37°



ROSCA THREAD	DN	Referencia Part n°	€
7/16" 20h UNF	1/4"	Z10420704	25,61
1/2" 20h UNF	1/4"	Z10420804	26,13
9/16" 18h UNF	3/8"	Z10420906	26,51
3/4" 16h UNF	1/2"	Z10421208	27,04
7/8" 14h UNF	1/2"	Z10421408	29,39
1"1/16 12h UN	3/4"	Z10421712	50,13
1"5/16 12h UN	1"	Z10422116	66,93
1"5/8 12h UN	1"1/4	Z10422620	111,82
1"7/8 12h UN	1"1/2	Z10423024	182,28

Welding fixed male JIC 37° with guide

Macho soldable JIC 37° con guía

Schweiß-Außengewinde JIC 37° mit AG

Mâle à souder JIC 37° avec guide



ROSCA THREAD	DN	Referencia Part n°	€
7/16" 20h UNF	1/4"	Z10360704	21,09
1/2" 20h UNF	1/4"	Z10360804	12,49
9/16" 18h UNF	3/8"	Z10360906	15,92
3/4" 16h UNF	3/8"	Z10361206	17,94
3/4" 16h UNF	1/2"	Z10361208	17,54
7/8" 14h UNF	1/2"	Z10361408	19,20
7/8" 14h UNF	5/8"	Z10361410	20,15
1"1/16 12h UN	3/4"	Z10361712	25,20
1"5/16 12h UN	1"	Z10362116	33,02
1"5/8 12h UN	1"1/4	Z10362620	52,22
1"7/8 12h UN	1"1/4	Z10363020	84,09
2" 1/2 12h UN	2"	NEW Z10364032	102,39

WELDING FITTINGS

Racores soldables
Schweißverschraubungen
Embouts à souder

DIN nut

Tuercas Métricas

Metr. Muttern - M DIN

Écrou DIN



TUBO PIPE	ROSCA THREAD	Referencia Part n°	€
6	M12X1.5	Z10510612	2,76
6	M14X1.5	Z10510614	3,03
8	M14X1.5	Z10510814	2,97
8	M16X1.5	Z10510816	3,41
10	M16X1.5	Z10511016	3,33
10	M18X1.5	Z10511018	4,09
12	M18X1.5	Z10511218	3,69
12	M20X1.5	Z10511220	4,54
14	M22X1.5	Z10511422	7,39
15	M22X1.5	Z10511522	5,34
16	M24X1.5	Z10511624	8,20
18	M26X1.5	Z10511826	8,29
20	M30X2	Z10512030	12,50
22	M30X2	Z10512230	10,77
25	M36X2	Z10512536	29,52
28	M36X2	Z10512836	22,16
30	M42X2	Z10513042	35,83
35	M45X2	Z10513545	34,66
38	M52X2	Z10513852	56,21
42	M52X2	Z10514252	42,10

Welding metal cone nipple

Boquilla para soldar cono metal

Schweißkegel Metallkonus

Raccord collet cône métallique à souder



TUBO PIPE	SERIE	Referencia Part n°	€
15X2,5	L	Z CMORIL 15	14,95
18X2,5	L	Z CMORIL 18	15,84
22X2,5	L	Z CMORIL 22	19,96
28X3	L	Z CMORIL 28	23,49
35X4	L	Z CMORIL 35	38,91
42X3	L	Z CMORIL 42	61,72
6X2	L/S	Z CMORIS 6	7,27
8X2	L/S	Z CMORIS 8	9,39
10X2	L/S	Z CMORIS 10	8,87
12X2	L/S	Z CMORIS 12	10,55
14X3	S	Z CMORIS 14	11,38
16X3	S	Z CMORIS 16	15,25
20X3	S	Z CMORIS 20	17,48
25X4	S	Z CMORIS 25	27,28
30X5	S	Z CMORIS 30	29,86
38X5	S	Z CMORIS 38	43,78

If you want the item with o'ring, please see page 124 / En caso de querer la pieza con junta, ver pág. 124 / Im Fall des Bedarfs des Artikels mit Dichtung vgl. Sie bitte S. 124 / Si vous voulez la pièce avec le joint, voir page 124

Welding metric standpipe

Espiga lisa métrica recta

Metr. Schweißstutzen glatt

Embout lisse métrique à souder



Ø EXT. Ø OUTER	Ø INT. Ø INNER	Referencia Part n°	€
10	7	KZL0010	7,93
12	9	KZL0012	8,20
14	10	KZL0014	11,31
15	12	KZL0015	10,84
16	12	KZL0016	12,27
18	14	KZL0018	16,03
20	14	KZL0020	19,27
22	18	KZL0022	20,57

Welding metric standpipe 90°

Espiga lisa métrica 90°

Metr. Schweißstutzen 90° glatt

Embout lisse métrique 90° à souder



Ø EXT. Ø OUTER	Ø INT. Ø INNER	Referencia Part n°	€
6	4	KZC9006	7,73
8	4	KZC9008	11,28
10	6	KZC9010	11,37
12	8	KZC9012	11,87
15	11	KZC9015	15,13
18	14	KZC9018	20,29
20	12	KZC9020	23,90
22	18	KZC9022	27,85

Welding metric standpipe 45°

Espiga lisa métrica 45°

Metr. Schweißstutzen 45° glatt

Embout lisse métrique 45° à souder



Ø EXT. Ø OUTER	Ø INT. Ø INNER	Referencia Part n°	€
6	4	KZC4506	7,73
8	4	KZC4508	11,28
10	6	KZC4510	11,37
12	8	KZC4512	11,87
14	10	KZC4514	13,94
15	11	KZC4515	15,13
16	11	KZC4516	17,54
18	14	KZC4518	20,29
20	12	KZC4520	23,91
22	18	KZC4522	27,85

WELDING FITTINGS

Racores soldables
Schweißverschraubungen
Embouts à souder

Weldable metrical swivel female 90°

Hembra giratoria 90° soldable métrica

Dichtkopf mit Ü-Mutter 90° metr. schweißbar

Femelle tournante 90° métrique à souder



TUBO PIPE	ROSCA THREAD	Referencia Part n°	€
10	M16X1.5	Z10521610	31,45
12	M18X1.5	Z10521812	30,06
15	M22X1.5	Z10522215	31,59
18	M26X1.5	Z10522618	45,14
22	M30X2	Z10523022	55,77
28	M36X2	Z10523628	79,01
42	M52X2	Z10525242	183,02
12	M20X1.5	Z10522012	34,91
20	M30X2	Z10523020	51,21

Weldable metrical swivel female 90° without o-ring



Hembra giratoria 90° soldable métrica sin junta

Dichtkopf mit Ü-Mutter 90° metr. schweißbar ohne Dichtung

Femelle tournante 90° métrique à souder sans joint



TUBO PIPE	ROSCA THREAD	Referencia Part n°	€
6	M12X1.5	Z10541206	21,81
8	M14X1.5	Z10541408	22,42
10	M16X1.5	Z10541610	30,50
12	M18X1.5	Z10541812	24,83
15	M22X1.5	Z10542215	30,64
18	M26X1.5	Z10542618	43,79
22	M30X2	Z10543022	54,09
28	M36X2	Z10543628	76,64
35	M45X2	Z10544535	134,32
42	M52X2	Z10545242	177,53
6	M14X1.5	Z10541406	22,82
8	M16X1.5	Z10541608	24,46
10	M18X1.5	Z10541810	23,66
12	M20X1.5	Z10542012	33,86
14	M22X1.5	Z10542214	28,60
16	M24X1.5	Z10542416	40,77
20	M30X2	Z10543020	49,68
25	M36X2	Z10543625	75,28
30	M42X2	Z10544230	110,72
38	M52X2	Z10545238	168,53

Weldable metrical swivel female 45°

Hembra giratoria 45° soldable métrica

Dichtkopf mit Ü-Mutter Bogen 45° metr. schweißbar

Femelle tournante 45° métrique à souder



TUBO PIPE	ROSCA THREAD	Referencia Part n°	€
10	M16X1.5	Z10531610	27,67
12	M18X1.5	Z10531812	27,64
15	M22X1.5	Z10532215	34,11
22	M30X2	Z10533022	60,22
28	M36X2	Z10533628	82,05
42	M52X2	Z10535242	197,66
20	M30X2	Z10533020	55,31

Weldable metrical swivel female 45° without o-ring



Hembra giratoria 45° soldable métrica sin junta

Dichtkopf mit Ü-Mutter Bogen 45° metr. schweißbar ohne Dichtung

Femelle tournante 45° métrique à souder sans joint



TUBO PIPE	ROSCA THREAD	Referencia Part n°	€
6	M12X1.5	Z10551206	23,56
8	M14X1.5	Z10551408	24,21
10	M16X1.5	Z10551610	32,94
12	M18X1.5	Z10551812	26,82
15	M22X1.5	Z10552215	33,09
18	M26X1.5	Z10552618	47,29
22	M30X2	Z10553022	58,42
28	M36X2	Z10553628	82,77
35	M45X2	Z10554535	145,06
42	M52X2	Z10555242	191,73
6	M14X1.5	Z10551406	24,64
8	M16X1.5	Z10551608	26,42
10	M18X1.5	Z10551810	25,55
12	M20X1.5	Z10552012	36,57
14	M22X1.5	Z10552214	30,89
16	M24X1.5	Z10552416	44,04
20	M30X2	Z10553020	53,65
25	M36X2	Z10553625	81,30
30	M42X2	Z10554230	119,58
38	M52X2	Z10555238	182,01

Welding DIN Male

Macho soldable Métrico

Schweiß-Außengewinde metr.

Male métrique à souder



TUBO PIPE	SERIE	Referencia Part n°	€
6	L	Z1050L06	7,60
8	L	Z1050L08	10,04
10	L	Z1050L10	9,83
12	L	Z1050L12	10,67
15	L	Z1050L15	16,83
18	L	Z1050L18	20,63
22	L	Z1050L22	31,58
28	L	Z1050L28	38,10
35	L	Z1050L35	61,87
42	L	Z1050L42	75,86
6	S	Z1050S06	9,46
8	S	Z1050S08	12,54
10	S	Z1050S10	14,46
12	S	Z1050S12	20,95
14	S	Z1050S14	22,20
16	S	Z1050S16	21,86
20	S	Z1050S20	26,57
25	S	Z1050S25	35,77
30	S	Z1050S30	53,62
38	S	Z1050S38	103,41

WELDING FITTINGS

Racores soldables
Schweißverschraubungen
Embouts à souder

Micro-casting BSP nuts AISI-316

Tuercas BSP Microfundido AISI-316

Muttern BSP Mikroguss AISI-316

Écrous BSP en acier moulé AISI-316



ROSCA THREAD	Referencia Part n°	€
2" 1/2 BSP	Z127040	121,95
3" BSP	Z127048	159,12
4" BSP	Z127064	202,89

Micro-casting BSPT welding male AISI-316

Macho BSPT soldar microfundido AISI-316

Außengewinde BSPT schweißbar Mikroguss AISI-316

Mâle BSPT à souder en acier moulé AISI-316



DN DN	ROSCA	Referencia Part n°	€
2" 1/2	2" 1/2 BSPT	ZM103240	130,61
3"	3" BSPT	ZM103248	160,14
4"	4" BSPT	ZM103264	206,13

Welding nipple with 60° cone for BSP nut with guide

Cono ajuste BSP 60° con guía

Schweißnippel DK 60 Dichtkegel 60° mit AG

Collet à souder BSP cone 60° avec guide



DN DN	ROSCA	Referencia Part n°	€
2" 1/2	2" 1/2 BSP	Z127840	99,26
3"	3" BSP	Z127848	125,57
4"	4" BSP	Z127864	229,37

WELDING FITTINGS

Racores soldables
Schweißverschraubungen
Embouts à souder

BSP Nut for welding 60° cone nipple

Tuerca cono ajuste BSP

Ü-Mutter BSP für DK

Écrou gaz pour collet à souder



ROSCA THREAD	Referencia Part n°	€
1/4" BSP	Z127004	4,20
3/8" BSP	Z127006	6,03
1/2" BSP	Z127008	5,19
3/4" BSP	Z127012	7,71
1" BSP	Z127016	13,45
1"1/4 BSP	Z127020	29,05
1"1/2 BSP	Z127024	36,46
2" BSP	Z127032	56,18

Welding nipple BSP 60°

Cono ajuste BSP 60°

Schweißnippel DK 60 Dichtkegel 60°

Collet à souder BSP cone 60°



ROSCA THREAD	Referencia Part n°	€
1/4" BSP	Z127304	4,47
3/8" BSP	Z127306	4,47
1/2" BSP	Z127308	6,36
3/4" BSP	Z127312	7,64
1" BSP	Z127316	12,77
1"1/4 BSP	Z127320	21,55
1"1/2 BSP	Z127324	38,98
2" BSP	Z127332	47,92

Welding nipple BSP flat seat

Cono ajuste BSP asiento plano

Schweißnippel DK 60 Dichtkegel 60° flachdichtend

Collet à souder BSP fond plat



ROSCA THREAD	Ø EXT. Ø OUTER	Referencia Part n°	€
1/2 BSP	16	Z127408	10,09
1"1/4 BSP	33	Z127420	24,36
2" BSP	52,4	Z127432	48,20
1"1/4 BSP	33	Z127920	24,36

Until end of stock / Hasta fin de existencias / Bis zum Ende des Lagerbestandes / Jusqu'à la fin du stock
Z127920 with guide / Z127920 con guía. / Z127920 mit Außengewinde / Z127920 avec guide.

Welding nipple for JIC 37° with guide

Cono ajuste JIC 37° con guía

Schweißnippel JIC 37° mit AG

Collet à souder femelle JIC cone 37° avec guide



ROSCA THREAD	DN	Referencia Part n°	€
7/16" 20h UNF	1/4"	Z12770704	9,32
1/2" 20h UNF	1/4"	Z12770804	9,92
9/16" 18h UNF	3/8"	Z12770906	7,53
3/4" 16h UNF	3/8"	Z12771206	8,65
7/8" 14h UNF	5/8"	Z12771410	8,83
1"1/16 12h UN	3/4"	Z12771712	13,63

Until end of stock / Hasta fin de existencias / Bis zum Ende des Lagerbestandes / Jusqu'à la fin du stock

Nut JIC 37°

Tuercas JIC 37°

Muttern JIC 37° - M JIC

Écrou JIC 37°



TUBO PIPE	ROSCA THREAD	Referencia Part n°	€
6	1/4"	7/16" 20h UNF	ZS11006 *
8	5/16"	1/2" 20h UNF	ZS11008 *
10	3/8"	9/16" 18h UNF	ZS11010 *
12	1/2"	3/4" 16h UNF	ZS11012 *
14-15-16	5/8"	7/8" 14h UNF	ZS11016 *
18-20	-	1"1/16 12h UN	ZS11020 *
-	3/4"	1"1/16 12h UNF	ZS11020W *
25	1"	1"5/16 12h UN	ZS11025 *
30-32	1 1/4"	1"5/8 12h UN	ZS11032 *
38	1 1/2"	1"7/8 12h UN	ZS11038 *

*See prices p. 131 (R.JIC) / *Ver precios en p.131 (R.JIC) / *Vgl. Sie die Preise auf S.131 (R.JIC) / *Voir prix p. 131 (R.JIC)

WELDING FITTINGS

Racores soldables
Schweißverschraubungen
Embouts à souder

Union 3 fem. welding pieces fig.340hs micro-casting

Unión 3 piezas hembra-soldar FIG.340HS
microfundido

3-teilige Schweißversch. w FIG. 340S Mikroguss

Union 3 pcs fem. à souder fig.340hs acier moulé



ROSCA THREAD	Referencia Part n°	€
1/4"	ZFIG34004HS	*
3/8"	ZFIG34006HS	*
1/2"	ZFIG34008HS	*
3/4"	ZFIG34012HS	*
1"	ZFIG34016HS	*
1" 1/4	ZFIG34020HS	*
1" 1/2	ZFIG34024HS	*
2"	ZFIG34032HS	*

*See prices p. 235 / *Ver precios en p.235 / *Vgl. Sie die Preise auf S. 235 / *Voir prix p. 235

Union 3 welding male pieces fig.341ms micro-casting

Unión 3 piezas macho-soldar FIG.341MS
microfundido

3-teilige Schweißversch. m FIG. 340ms Mikroguss

Union 3 pcs mâle à souder fig.341ms acier moulé



ROSCA THREAD	Referencia Part n°	€
1/4"	ZFIG34104MS	*
3/8"	ZFIG34106MS	*
1/2"	ZFIG34108MS	*
3/4"	ZFIG34112MS	*
1"	ZFIG34116MS	*
1" 1/4	ZFIG34120MS	*
1" 1/2	ZFIG34124MS	*
2"	ZFIG34132MS	*

*See prices p. 235 / *Ver precios en p.235 / *Vgl. Sie die Preise auf S. 235 / *Voir prix p. 235

Union 3 welding pieces fig. 340s micro-casting

Unión 3 piezas soldar FIG.340S microfundido

3-teilige Schweißversch. FIG. 340s Mikroguss

Union 3 pièces à souder fig. 340s acier moulé



DN	Referencia Part n°	€
1/4"	ZFIG34004S	*
3/8"	ZFIG34006S	*
1/2"	ZFIG34008S	*
3/4"	ZFIG34012S	*
1"	ZFIG34016S	*
1" 1/4	ZFIG34020S	*
1" 1/2	ZFIG34024S	*
2"	ZFIG34032S	*

*See prices p. 235 / *Ver precios en p.235 / *Vgl. Sie die Preise auf S. 235 / *Voir prix p. 235

WELDING FLANGES

Bridas soldables
Schweißflansche
Brides à souder

Welding forged flange DIN 2633 PN 10/16

Brida fija soldable PN10/16 DIN 2633

Vorschweißflansch DIN 2633 PN 10/16

Bride fixe à souder DIN 2633 PN10/16



DN	Referencia Part n°	€
15-1/2"	ZBPN16263308	33,52
20-3/4"	ZBPN16263312	44,64
25-1"	ZBPN16263316	58,79
32-1"1/4	ZBPN16263320	79,42
40-1"1/2	ZBPN16263324	94,37
50-2"	ZBPN16263332	125,79
65-2"1/2	ZBPN16263340	143,80
80-3"	ZBPN16263348	151,37
100-4"	ZBPN16263364	223,68

Welding forged flange DIN 2635 PN 40

Brida fija soldable PN40 DIN 2635

Vorschweißflansch DIN 2635 PN 40

Bride fixe à souder DIN 2635 PN 40



DN	Referencia Part n°	€
15-1/2"	ZBPN40263508	33,86
20-3/4"	ZBPN40263512	49,80
25-1"	ZBPN40263516	60,64
32-1"1/4	ZBPN40263520	84,91
40-1"1/2	ZBPN40263524	109,47
50-2"	ZBPN40263532	132,50
65-2"1/2	ZBPN40263540	175,72
80-3"	ZBPN40263548	214,62
100-4"	ZBPN40263564	294,57

Flange ANSI-ASA Welding Neck 150 LBS

Brida fija ANSI-ASA 150 LBS

Flansch ANSI-ASA W.NECK 150 LBS

Bride ANSI-ASA Welding Neck 150 LBS



DN	Referencia Part n°	€
15-1/2"	ZBANSAWN15008	26,33
20-3/4"	ZBANSAWN15012	37,61
25-1"	ZBANSAWN15016	53,09
32-1"1/4	ZBANSAWN15020	65,50
40-1"1/2	ZBANSAWN15024	84,91
50-2"	ZBANSAWN15032	126,03
65-2"1/2	ZBANSAWN15040	200,09
80-3"	ZBANSAWN15048	247,13
100-4"	ZBANSAWN15064	332,45

FLANGE ANSI-ASA Welding Neck 300 LBS

Brida fija ANSI-ASA 350 LBS

Flansch ANSI-ASA W.NECK 300 LBS

Bride ANSI-ASA Welding Neck 300 LBS

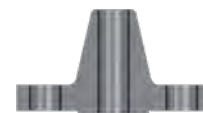

DN	Referencia Part n°	€
15-1/2"	ZBANSAWN30008	39,49
20-3/4"	ZBANSAWN30012	65,27
25-1"	ZBANSAWN30016	82,26
32-1"1/4	ZBANSAWN30020	99,87
40-1"1/2	ZBANSAWN30024	147,53
50-2"	ZBANSAWN30032	173,41
65-2"1/2	ZBANSAWN30040	251,14
80-3"	ZBANSAWN30048	332,02
100-4"	ZBANSAWN30064	539,38

WELDING FLANGES

Bridas soldables

Schweißflansche

Brides à souder

Welding forged slip on flange DIN 2642 PN 10

Brida loca PN10 DIN 2642

Vorschweißflansch DIN 2642 PN 10



Bride tournante à souder DIN 2642 PN 10

DN	Referencia Part n°	€
15-1/2"	ZBPN10264208	27,92
20-3/4"	ZBPN10264212	34,15
25-1"	ZBPN10264216	59,27
32-1"1/4	ZBPN10264220	67,85
40-1"1/2	ZBPN10264224	75,53
50-2"	ZBPN10264232	89,05
65-2"1/2	ZBPN10264240	134,04
80-3"	ZBPN10264248	185,10
100-4"	ZBPN10264264	227,95

Ring for flange DIN 2642

Aro para brida DIN 2642

Ring für Flansche DIN 2642



Collet épais pour bride DIN 2642

DN	Referencia Part n°	€
1/2"	ZABARO264208	13,85
3/4"	ZABARO264212	30,23
1"	ZABARO264216	38,98
1"1/4	ZABARO264220	48,59
1"1/2	ZABARO264224	60,13
2"	ZABARO264232	45,76
2"1/2	ZABARO264240	147,26
3"	ZABARO264248	243,48
4"	ZABARO264264	239,02

Tube for welding flanges ANSI-DIN

Tubo para soldar bridas ANSI-DIN

Rohr für Schweißflansche ANSI-DIN



Tube à souder brides ANSI-DIN

DN	Referencia Part n°	€
3/8"	ZBTUBO06	6,39
1/2"	ZBTUBO08	10,33
3/4"	ZBTUBO12	8,81
1"	ZBTUBO16	9,72
1"1/4	ZBTUBO20	12,35
1"1/2	ZBTUBO24	15,43
2"	ZBTUBO32	21,67
2"1/2	ZBTUBO40	21,27
3"	ZBTUBO48	29,82
4"	ZBTUBO64	40,19

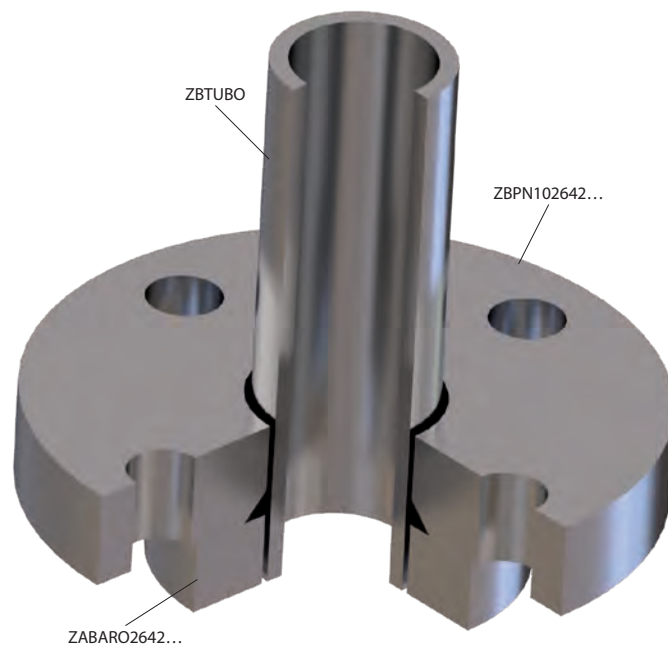

WELDING FLANGES

Bridas soldables
Schweißflansche
Brides à souder

Welding forged flange DIN 2656 PN 40

Brida plana PN40 DIN 2656

Vorschweißflansch DIN 2656 PN 40

Bride tournante à souder DIN 2656 PN 40



DN	Referencia Part n°	€
15-1/2"	ZBPN40265608	32,10
20-3/4"	ZBPN40265612	38,68
25-1"	ZBPN40265616	47,13
32-1"1/4	ZBPN40265620	76,56
40-1"1/2	ZBPN40265624	86,62
50-2"	ZBPN40265632	113,21
65-2"1/2	ZBPN40265640	123,72
80-3"	ZBPN40265648	161,49
100-4"	ZBPN40265664	209,32

Ring for flange DIN 2656

Aro para brida DIN 2656

Ring für Flansche DIN 2656

Collet épais pour bride DIN 2656



DN	Referencia Part n°	€
1/2"	ZABARO265608	16,00
3/4"	ZABARO265612	32,40
1"	ZABARO265616	41,75
1"1/4	ZABARO265620	49,84
1"1/2	ZABARO265624	65,63
2"	ZABARO265632	94,07
2"1/2	ZABARO265640	132,50
3"	ZABARO265648	168,13

Tube for welding flanges ANSI-DIN

Tube para soldar bridas ANSI-DIN

Rohr für Schweißflansche ANSI-DIN

Tube à souder brides ANSI-DIN



	Referencia Part n°	€
3/8"	ZBTUB006	6,39
1/2"	ZBTUB008	10,33
3/4"	ZBTUB012	8,81
1"	ZBTUB016	9,72
1"1/4	ZBTUB020	12,35
1"1/2	ZBTUB024	15,43
2"	ZBTUB032	21,67
2"1/2	ZBTUB040	21,27
3"	ZBTUB048	29,82
4"	ZBTUB064	40,19

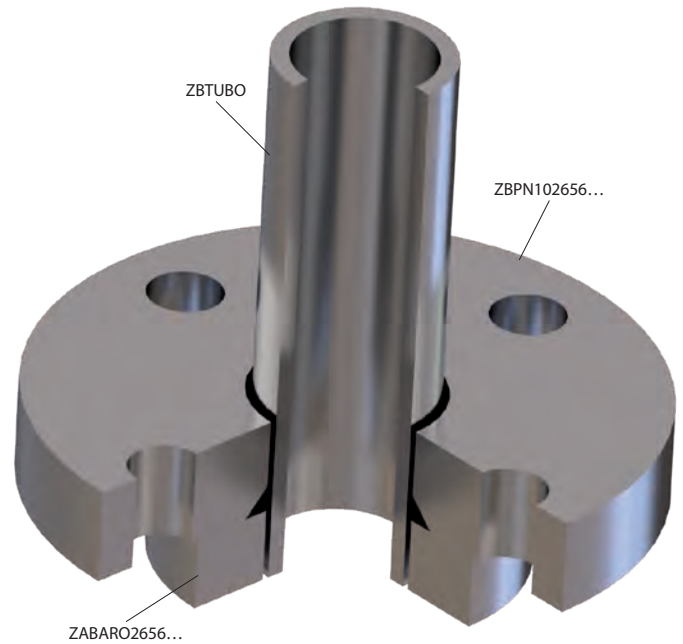

WELDING FLANGES

Bridas soldables

Schweißflansche

Brides à souder

Swivel flange ANSI-ASA 150 LBS

Brida plana ANSI-ASA 150 LBS

Flansch ANSI-ASA 150 LBS

Bride tournante ANSI-ASA 150 LBS



DN	Referencia Part n°	€
15-1/2"	ZBANSASO15008	19,39
20-3/4"	ZBANSASO15012	26,85
25-1"	ZBANSASO15016	37,00
32-1"1/4	ZBANSASO15020	46,09
40-1"1/2	ZBANSASO15024	62,08
50-2"	ZBANSASO15032	96,39
65-2"1/2	ZBANSASO15040	143,48
80-3"	ZBANSASO15048	183,55
100-4"	ZBANSASO15064	246,42

Swivel flange ANSI-ASA 300 LBS

Brida plana ANSI-ASA 300 LBS

Flansch ANSI-ASA 300 LBS

Bride tournante ANSI-ASA 300 LBS



DN	Referencia Part n°	€
15-1/2"	ZBANSASO30008	30,77
20-3/4"	ZBANSASO30012	50,80
25-1"	ZBANSASO30016	64,74
32-1"1/4	ZBANSASO30020	76,18
40-1"1/2	ZBANSASO30024	116,58
50-2"	ZBANSASO30032	135,97
65-2"1/2	ZBANSASO30040	199,31
80-3"	ZBANSASO30048	445,90

Ring for flange ANSI-ASA

Aro para brida ANSI-ASA

Ring für Flansche ANSI-ASA

Collet épais pour brida ANSI-ASA



DN	Referencia Part n°	€
1/2"	ZABAROANSA08	6,82
3/4"	ZABAROANSA12	8,92
1"	ZABAROANSA16	10,69
1"1/4	ZABAROANSA20	15,50
1"1/2	ZABAROANSA24	20,85
2"	ZABAROANSA32	53,88
2"1/2	ZABAROANSA40	41,79
3"	ZABAROANSA48	59,61
4"	ZABAROANSA64	85,18

Tube for welding flanges ANSI-DIN

Tubo para soldar bridas ANSI-DIN

Rohr für Schweißflansche ANSI-DIN

Tube à souder brides ANSI-DIN



	Referencia Part n°	€
3/8"	ZBTUBO06	6,39
1/2"	ZBTUBO08	10,33
3/4"	ZBTUBO12	8,81
1"	ZBTUBO16	9,72
1"1/4	ZBTUBO20	12,35
1"1/2	ZBTUBO24	15,43
2"	ZBTUBO32	21,67
2"1/2	ZBTUBO40	21,27
3"	ZBTUBO48	29,82
4"	ZBTUBO64	40,19

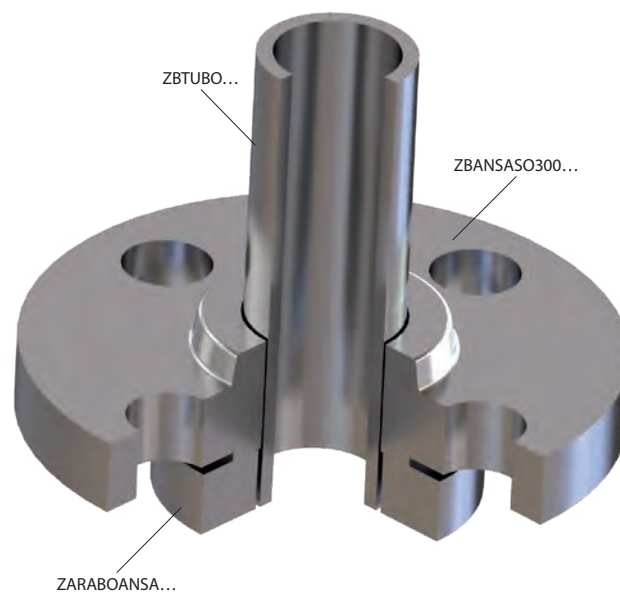
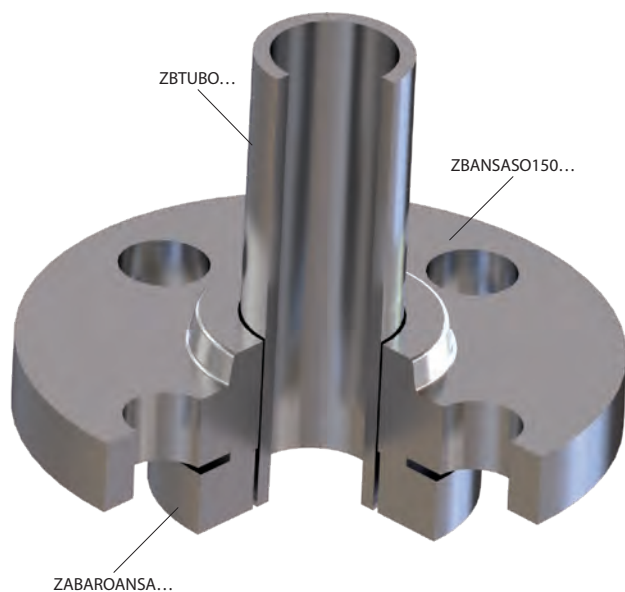



A HUNDRED HEADS. ONE MIND.

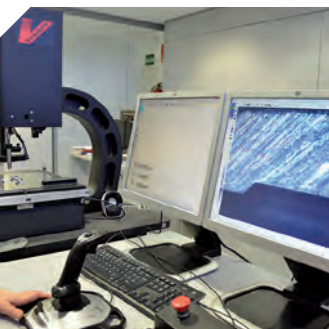
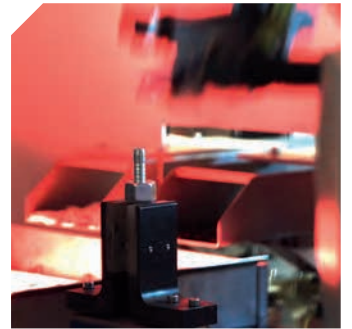
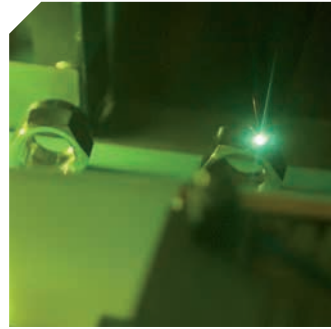
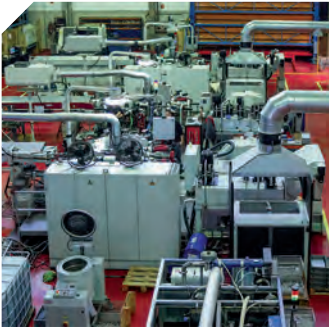

FABRICACIÓN • MANUFACTURE
 LOGÍSTICA • LOGISTICS
 ÁREA CALIDAD • QUALITY DEPARTMENT
 ÁREA TÉCNICA • TECHNICAL DEPARTMENT
 TALLER HIDRÁULICA • HYDRAULIC WORKSHOP
 TALLER LATIGUILLOS • HOSE ASSEMBLY WORKSHOP
 TALLER SOLDADURA • WELDING WORKSHOP
 SERVICIOS COMERCIALES • COMMERCIAL SERVICES
 PLATAFORMA DIGITAL • DIGITAL PLATFORM

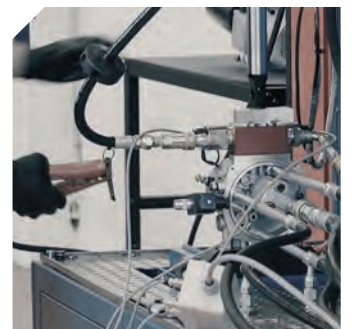

FOOD INDUSTRY FITTINGS | 217

Racores industria alimentaria
Kupplungen für Lebensmittelindustrie
Raccords alimentaires

DIN 2828 CAMLOCK FITTINGS | 224

Serie Camlock DIN 2828
CAMLOCK AISI 316 - DIN 2828
Raccords Camlock DIN 2828

GUILLEMIN NF E-29572 FITTINGS | 228

Acoples GUILLEMIN NF E-29572
Kupplungen GUILLEMIN NF E-29572
Raccords GUILLEMIN NF E-29572

TW (TANKWAGEN) DIN 28450 FITTINGS | 230

Acoples TW (Tankwagen) DIN 28450
Kupplungen TW (Tankwagen) DIN 28450
Raccords TW (Tankwagen) DIN 28450

STAINLESS STEEL ACCESSORIES FOR INDUSTRIAL FITTING | 231

Accesorios inox para racor industrial
Edelstahl-Zubehör für Industriekupplungen
Accessoires acier inox pour raccord industriel

SCREW LOW PRESSURE FITTINGS 150 LBS | 232

Racores baja presión 150 LBS
Niederdruck-Armaturen 150 lbs
Raccords basse pression 150 LBS

06

INDUSTRIAL FITTINGS

Racores industriales
Industriekupplungen
Raccords industriels



FOOD INDUSTRY FITTINGS

Racores industria alimentaria
Kupplungen für Lebensmittelindustrie
Raccords alimentaires

Crimping ferrules ▪ Casquillos para presnar ▪ Pressfassungen ▪ Jupes à sertir | 217



81042

SMS Unions ▪ Racores SMS ▪ SMS-Armaturen ▪ Raccords SMS | 218



ZRA200



ZRA212



ZSMS H



ZSMS S



ZSMS M



Z SMS BN



JSMSS



JSMSP

Clamp Unions ▪ Racores Tri-Clamp ▪ TRI-CLAMP-Armaturen ▪ Raccords Tri-Clamp | 220



ZTC



ZC



JCLAMPS



JCLAMPP



ZAC1P



ZPC

DIN 11851 Unions ▪ Racores DIN 11851 ▪ Verschraubungen Din 11851 ▪ Raccords DIN 11851 | 221



ZRA100



ZRA112



ZDIN H



Z DIN BN



ZDIN S



ZDIN M



JDINS



JDINP

Macon Unions ▪ Racores Macon ▪ Verschraubungen Macon ▪ Raccords Macon | 222



ZRA300



ZRA312



ZMAC H

Food industry fittings for PTFE hose STD Series ▪ Racores alimentarios para manguera PTFE Serie STD ▪ Lebensmittelarmaturen für PTFE Serie STD ▪ Raccords alimentaires pour tuyau PTFE Série STD | 223



ZRA250



ZRA150



ZRA252



ZRA152



ZTCS



81040



81041

DIN 2828 CAMLOCK FITTINGS

Serie Camlock DIN 2828
CAMLOCK AISI 316 - DIN 2828
Raccords Camlock DIN 2828

Camlock Unions AISI 316 ▪ Racores Camlock AISI 316 ▪ CAMLOCK AISI 316 ▪ Raccords Camlock AISI 316

224



AUTOLOCK UNIONS AISI 316

Racores Autolock AISI 316
AUTOLOCK AISI 316
Raccords Autolock AISI 316

Autolock Unions AISI 316 ▪ Racores Autolock AISI 316 ▪ AUTOLOCK AISI 316 ▪ Raccords Autolock AISI 316

227



GUILLEMIN NF E-29572 FITTINGS

Acoples GUILLEMIN NF E-29572
Kupplungen GUILLEMIN NF E-29572
Raccords GUILLEMIN NF E-29572

GUILLEMIN Stainless Steel ▪ GUILLEMIN inox ▪ GUILLEMIN Edelstahl ▪ GUILLEMIN acier inox

228



TW (TANKWAGEN) DIN 28450 FITTINGS

Acoples TW (Tankwagen) DIN 28450
Kupplungen TW (Tankwagen) DIN 28450
Raccords TW (Tankwagen) DIN 28450

TW Stainless Steel ▪ TW (Tankwagen) inox ▪ TW Edelstahl ▪ TW acier inox

230



STAINLESS STEEL ACCESSORIES FOR INDUSTRIAL FITTING

Accesorios inox para racor industrial
Edelstahl-Zubehör für Industriekupplungen
Accessoires acier inox pour raccord industriel

CRIMPING FITTINGS
FOR HOSES

PIPE
FITTINGS

Stainless Steel Crimping Ferrule for industrial fitting ▪ Campana inox para racor industrial ▪ Edelstahl-Hülse für Industriekupplungen ▪ Jupe pour raccord industriel acier inox

231



ZCA

PIPE
FITTINGS II

Stainless Steel clamp for industrial fitting ▪ Abrazadera inox para racor industrial ▪ Edelstahl-Schelle für Industriekupplung ▪ Collier pour raccord industriel acier inox

231



ZAB01



ZAB02

ADAPTORS

SCREW LOW PRESSURE FITTINGS 150 LBS

Racores baja presión 150 LBS
Niederdruck-Armaturen 150 lbs
Raccords basse pression 150 LBS

WELDING
FITTINGS

Screwed fittings low pressure 150 LBS ▪ 150 LBS Microfundido ▪ Niederdruck-Armaturen 150 lbs ▪ Adapteurs basse pression 150 LBS

232

INDUSTRIAL
FITTINGS



ZFIG399

ZFIG150

ZFIG290

ZFIG280

ZFIG245

ZFIG312

ZFIG300

ZFIG270

ZFIG291

ZFIG301

ZFIG241

ZFIG531

ZFIG240

ZFIG090

ZFIG120

ZFIG092

ZFIG130

ZFIG180

ZFIG340

ZFIG341

ZFIG149

ACCESSORIES

CONTROL
COMPONENTS

Welding fittings low pressure 150 LBS ▪ 150 LBS Soldables ▪ Niederdruck-Schweißarmaturen 150 LBS ▪ Raccords à souder basse pression 150 LBS

235



ZFIG340...HS



ZFIG340...S



ZFIG341...MS

FLOW
MEASURING

150 LBS fittings Valves ▪ 150 LBS Válvulas ▪ 150 LBS-Armaturen-Ventile ▪ Raccords Vannes 150 LBS

236



BP2V3P



BP2V

TRALE LOK

FOOD INDUSTRY FITTINGS

Racores industria alimentaria
Kupplungen für Lebensmittelindustrie
Raccords alimentaires

Food industry hoses ferrules

Casquillos para mangueras alimentarias

Pressfassungen für Lebensmittelschläuche

Jupes à sertir tuyaux alimentaires

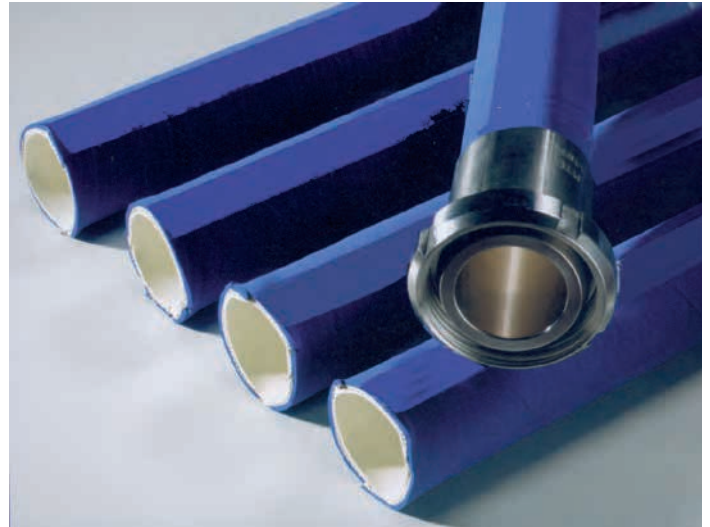

DN	Ø MANGUERA Ø HOSE	Referencia Part n°	€
13-1/2"	23	810421324	16,59
19-3/4"	32	810421933	21,82
25-1"	39	810422540	23,49
32-1"1/4	48	810423248	38,82
38-1"1/2	52	810423852	51,36
38-1"1/2	56	810423857	62,93
40-1"1/2	54	810424055	57,71
40-1"1/2	60	810424061	92,49
50-2"	63	810425064	71,41
50-2"	68	810425069	87,54
50-2"	73	810425073	95,15
65-2"1/2	79	810426580	94,76
65-2"1/2	93	810426593	161,37
70-3"	89	810427090	198,72
75-3"	94	810427595	149,56
75-3"	106	8104275107	195,24
100-4"	122	81042100123	211,33
100-4"	134	81042100135	351,59



MANGUERAS ALIMENTARIAS | FOOD INDUSTRY HOSES



INDUG TrAde 25X37 DRINKS (máx.40%) EPDM S&D

INDUG TrAde 25X38 MILK & DAIRY NR S&D FDA

INDUG TrAde FOOD S&D HOSE FDA WP 10 bar

Mangueras aptas para productos alimentarios de aspiración e impulsión:
Leche, vino, aceites, alimentos grasos, bebidas alcohol (máx. 40%), etc.

*Professional hoses application in the food industry for suction and discharge:
Milk, wine, oils, fatty foods, alcohol drinks (max 40%), etc.*

Consulta en nuestra ficha técnica datos y marcajes. | Check our technical sheet for data and markings options.
Ver precios en Catálogo Conducciones. | See prices in Connectors Catalogue.

FOOD INDUSTRY FITTINGS

Racores industria alimentaria
Kupplungen für Lebensmittelindustrie
Raccords alimentaires

Swivel female SMS

Hembras giratorias SMS

Dichtkopf mit Ü-Mutter SMS

Raccord femelle tournante SMS



ROSCA THREAD	DN	Referencia Part n°	€
40x1/6"	25	ZRA2004025	39,62
48x1/6"	32	ZRA2004832	60,85
60x1/6"	38	ZRA2006038	77,94
60x1/6"	40	ZRA2006040	81,59
70x1/6"	50	ZRA2007050	110,93
85x1/6"	63	ZRA2008563	188,26
85x1/6"	65	ZRA2008565	173,03
98x1/6"	70	ZRA2009870	275,63
98x1/6"	75	ZRA2009875	259,52
98x1/6"	80	ZRA2009880	303,01
125x1/4"	100	ZRA200125100	406,26
132x1/4"	100	ZRA200132100	452,37

Fixed male SMS

Machos fijos SMS

Außengewinde SMS

Raccord mâle SMS



ROSCA THREAD	DN	Referencia Part n°	€
40x1/6"	25	ZRA2124025	50,67
48x1/6"	32	ZRA2124832	64,29
60x1/6"	38	ZRA2126038	89,82
60x1/6"	40	ZRA2126040	80,91
70x1/6"	50	ZRA2127050	124,94
85x1/6"	63	ZRA2128563	178,23
85x1/6"	65	ZRA2128565	162,74
98x1/6"	70	ZRA2129870	321,14
98x1/6"	75	ZRA2129875	366,87
98x1/6"	80	ZRA2129880	321,24
125x1/4"	100	ZRA212125100	429,31
132x1/4"	100	ZRA212132100	439,82

Nuts SMS

Tuercas SMS

Muttern SMS

Écrou SMS

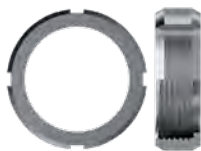

ROSCA THREAD	DN	Referencia Part n°	€
40x1/6"	25	ZSMS H 25	12,74
48x1/6"	32	ZSMS H 32	17,48
60x1/6"	38	ZSMS H 38	23,75
70x1/6"	51	ZSMS H 51	28,52
85x1/6"	63	ZSMS H 63	42,41
98x1/6"	76	ZSMS H 76	55,78
125x1/4"	104	ZSMS H 104	68,41
132x1/4"	104	ZSMS H 105	92,70

Liner to weld SMS

Conos soldables SMS

Schweißkegel SMS

Douilles à souder SMS



DN	Referencia Part n°	€
25	ZSMS S 25	4,54
32	ZSMS S 32	8,24
38	ZSMS S 38	8,65
51	ZSMS S 51	9,91
63	ZSMS S 63	14,32
76	ZSMS S 76	20,51
104	ZSMS S 104	27,32

Weld male SMS

Machos soldables SMS

Schweiß-Außengewinde SMS

Nez à souder SMS



ROSCA THREAD	DN	Referencia Part n°	€
40x1/6"	25	ZSMS M 25	8,40
48x1/6"	32	ZSMS M 32	16,27
60x1/6"	38	ZSMS M 38	17,09
70x1/6"	51	ZSMS M 51	20,07
85x1/6"	63	ZSMS M 63	30,07
98x1/6"	76	ZSMS M 76	36,34
125x1/4"	104	ZSMS M 104	53,26

FOOD INDUSTRY FITTINGS

Racores industria alimentaria
Kupplungen für Lebensmittelindustrie
Raccords alimentaires

Blind round nut SMS

Tapones SMS

Blindrundmutter SMS

Ecrou Bouchon Avec Chainette



NEW

DN	ROSCA THREAD	Referencia Part n°	€
25	40X1/6"	Z SMS BN 25	*
38	60X1/6"	Z SMS BN 38	*
51	70X1/6"	Z SMS BN 51	*
63	85X1/6"	Z SMS BN 63	*
76	98X1/6"	Z SMS BN 76	*
104	125X1/4"	Z SMS BN 104	*

Silicone joint for SMS

Junta SMS silicona

Silikon-Dichtring SMS

Joint silicone pour SMS



DN	Referencia Part n°	€
25	JSMSS 25	2,58
32	JSMSS 32	3,19
38	JSMSS 38	3,64
51	JSMSS 51	4,00
63	JSMSS 63	5,33
76	JSMSS 76	5,90
104	JSMSS 104	6,84

PTFE Joint for SMS

Juntas SMS PTFE

PTFE-Dichtringe SMS

Joint PTFE pour SMS

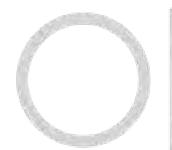

DN	Referencia Part n°	€
25	JSMSP 25	6,40
32	JSMSP 32	7,74
38	JSMSP 38	9,86
51	JSMSP 51	10,91
63	JSMSP 63	15,28
76	JSMSP 76	19,65

CRIMPING FITTINGS
FOR HOSES

PIPE
FITTINGS

PIPE
FITTINGS II

ADAPTORS

WELDING
FITTINGS

INDUSTRIAL
FITTINGS

ACCESSORIES

CONTROL
COMPONENTS

FLOW
MEASURING

TRALE LOK

FOOD INDUSTRY FITTINGS

Racores industria alimentaria
Kupplungen für Lebensmittelindustrie
Raccords alimentaires

Tri-Clamp ISO 2852

Tri-Clamp ISO 2852

Spannringskupplung TRI-CLAMP ISO 2852

Raccord Tri-Clamp ISO 2852



∅	DN	Referencia Part n°	€
25	12	ZTC2512	24,29
34	12	ZTC3412	37,01
34	19	ZTC3419	37,33
50,5	19	ZTC5019	41,99
50,5	25	ZTC5025	39,43
50,5	32	ZTC5032	46,05
50,5	38	ZTC5038	49,41
50,5	40	ZTC5040	59,97
64	38	ZTC6438	84,11
64	40	ZTC6440	77,97
64	50	ZTC6450	78,27
77,5	50	ZTC7750	127,99
77,5	65	NEW ZTC7763	161,88
91	65	ZTC9165	198,94
91	75	NEW ZTC9175	204,92

Welding Tri-Clamp for pipe

Tri-Clamp para soldar en tubo

TRI-CLAMP zum Rohr-Schweißen

Raccord Tri-Clamp à souder pour tube



∅	DN	Referencia Part n°	€
25	12	ZC25-12	8,08
34	12	ZC34-12	8,71
34	18	ZC34-18	8,71
50,5	18	ZC50-18	9,40
50,5	25	ZC50-25	8,71
50,5	33,7	ZC50-33,7	9,98
50,5	38	ZC50-38	9,57
64	38	ZC64-38	14,72
64	51	ZC64-51	12,50
91	65	ZC91-65	16,34

Joint for silicone clamp

Juntas para Clamp Silicona

Dichtring für Schelle Silikon

Joint pour clamp silicone

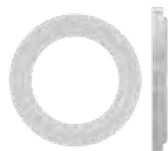

∅	Referencia Part n°	€
25	JCLAMPS 25	5,10
34	JCLAMPS 34	5,10
50	JCLAMPS 50	5,17
64	JCLAMPS 64	7,00
77	JCLAMPS 77	9,65
91	JCLAMPS 91	13,58

Joint for PTFE clamp

Juntas para Clamp PTFE

Dichtring für Schelle PTFE

Joint pour clamp PTFE

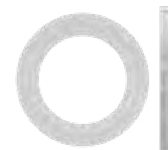

∅	Referencia Part n°	€
25	JCLAMPP 25	*
34	JCLAMPP 34	*
50	JCLAMPP 50	*
64	JCLAMPP 64	*
77	JCLAMPP 77	*
91	JCLAMPP 91	*

Tri-Clamp with 1 pin

Abrazaderas Tri-clamp con 1 pin

TRI-CLAMP mit 1 pin

Collier Tri-Clamp avec 1 pin



∅	Referencia Part n°	€
25	ZAC1P25	14,98
34	ZAC1P34	14,98
50	ZAC1P50	17,73
64	ZAC1P64	21,36
77	ZAC1P77	25,60
91	ZAC1P91	28,46

Tri-Clamp cover

Tri-Clamp Tapa

TRI-CLAMP Deckel

Tri-Clamp Couvercle



∅	Referencia Part n°	€
25	ZPC25	6,06
34	ZPC34	6,44
50,5	ZPC50	7,64
64	ZPC64	10,10
77,5	ZPC77	13,44
91	ZPC91	16,53

FOOD INDUSTRY FITTINGS

Racores industria alimentaria
Kupplungen für Lebensmittelindustrie
Raccords alimentaires

Swivel female DIN 11851

Hembras giratorias DIN 11851

Dichtkopf mit Ü-Mutter DIN 11851

Raccord femelle tournante DIN 11851



ROSCA THREAD	DN	Referencia Part n°	€
44x1/6"	20	ZRA1004420	49,14
52x1/6"	25	ZRA1005225	51,48
58x1/6"	32	ZRA1005832	66,70
65x1/6"	38	ZRA1006538	73,89
65x1/6"	40	ZRA1006540	78,05
78x1/6"	50	ZRA1007850	120,42
95x1/6"	63	ZRA1009563	203,36
95x1/6"	65	ZRA1009565	209,12
110x1/4"	75	ZRA10011075	299,19
110x1/4"	80	ZRA10011080	326,57
130x1/4"	100	ZRA100130100	465,63

Fixed male DIN 11851

Machos fijos DIN 11851

Außengewinde DIN 11851 fest

Raccord mâle DIN 11851



ROSCA THREAD	DN	Referencia Part n°	€
52x1/6"	25	ZRA1125225	79,77
58x1/6"	32	ZRA1125832	87,29
65x1/6"	38	ZRA1126538	130,16
65x1/6"	40	ZRA1126540	132,98
78x1/6"	50	ZRA1127850	154,08
95x1/6"	63	ZRA1129563	247,37
95x1/6"	65	ZRA1129565	243,99
110x1/4"	75	ZRA11211075	360,57
110x1/4"	80	ZRA11211080	345,48
130x1/4"	100	ZRA112130100	577,91

Nuts DIN 11851

Tuercas DIN 11851

Muttern DIN 11851

Écrous DIN 11851



ROSCA THREAD	DN	Referencia Part n°	€
34x1/8"	16	ZDIN H 16	10,01
44x1/6"	20	ZDIN H 20	13,49
52x1/6"	25	ZDIN H 25	17,16
58x1/6"	32	ZDIN H 32	19,37
65x1/6"	40	ZDIN H 40	22,78
78x1/6"	50	ZDIN H 50	29,66
95x1/6"	65	ZDIN H 65	46,32
110x1/4"	80	ZDIN H 80	64,75
130x1/4"	100	ZDIN H 100	86,20

DIN 11851 Blind round nut

Tapones DIN 11851

DIN 11851 Blindrundmutter

DIN 11851 Ecrou Bouchon Avec Chainette



NEW

DN	ROSCA	Referencia Part n°	€
20	44X1/6"	Z DIN BN 20	*
25	52X1/6"	Z DIN BN 25	*
32	58X1/6"	Z DIN BN 32	*
40	65X1/6"	Z DIN BN 40	*
50	78X1/6"	Z DIN BN 50	*
65	95X1/6"	Z DIN BN 65	*
80	110X1/4"	Z DIN BN 80	*

Liner to weld DIN 11851

Conos soldables DIN 11851

Schweißkegel DIN 11851

Douilles à souder DIN 11851



DN	Referencia Part n°	€
16	ZDIN S 16	4,05
20	ZDIN S 20	5,74
25	ZDIN S 25	8,08
32	ZDIN S 32	10,08
40	ZDIN S 40	11,74
50	ZDIN S 50	21,18
65	ZDIN S 65	26,17
75/80	ZDIN S 80	35,59
100	ZDIN S 100	56,90

Weld male DIN 11851

Machos soldables DIN 11851

Schweiß-Außengewinde DIN 11851

Nez à souder DIN 11851



ROSCA THREAD	DN	Referencia Part n°	€
34x1/8"	16	ZDIN M 16	7,72
44x1/6"	20	ZDIN M 20	11,48
52x1/6"	25	ZDIN M 25	12,24
58x1/6"	32	ZDIN M 32	15,21
65x1/6"	40	ZDIN M 40	19,03
78x1/6"	50	ZDIN M 50	27,95
95x1/6"	65	ZDIN M 65	38,40
110x1/4"	75/80	ZDIN M 80	57,15
130x1/4"	100	ZDIN M 100	75,15

CRIMPING FITTINGS FOR HOSES
PIPE FITTINGS
PIPE FITTINGS II
ADAPTORS
WELDING FITTINGS
INDUSTRIAL FITTINGS
ACCESSORIES
CONTROL COMPONENTS
FLOW MEASURING
TRALE LOK

FOOD INDUSTRY FITTINGS

Racores industria alimentaria
Kupplungen für Lebensmittelindustrie
Raccords alimentaires

Silicone joint for DIN 11851

Juntas DIN 11851 silicona

Silikon-Dichtring DIN 11851

Joint silicone pour DIN 11851

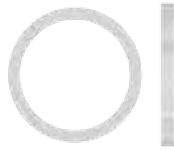

DN	Referencia Part n°	€
20	JDINS 20	1,42
25	JDINS 25	2,22
32	JDINS 32	2,58
40	JDINS 40	2,75
50	JDINS 50	3,56
65	JDINS 65	4,62
80	JDINS 80	5,96
100	JDINS 100	7,61

PTFE Joint for DIN 11851

Juntas DIN 11851 PTFE

PTFE-Dichtring DIN 11851

Joint PTFE pour DIN 11851

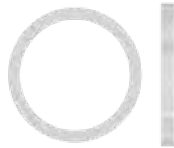

DN	Referencia Part n°	€
20	JDINP 20	9,86
25	JDINP 25	10,58
32	JDINP 32	11,11
40	JDINP 40	12,08
50	JDINP 50	13,61
65	JDINP 65	15,03
80	JDINP 80	16,07
100	JDINP 100	56,02

Swivel female Macon

Hembras giratorias Macon

Dichtkopf mit Ü-Mutter MACON

Raccord femelle tournante Macon



ROSCA THREAD	DN	Referencia Part n°	€
M55x3	38	ZRA3005538	*
M55x3	40	ZRA3005540	*
M67x3	50	ZRA3006750	*
M79x3,5	65	ZRA3007965	*
M90x3,5	65	ZRA3009065	*
M90x3,5	70	ZRA3009070	*
M90x3,5	80	ZRA3009080	*
M102x4	80	ZRA30010280	*

Male fixe Macon

Machos fijos Macon

Außengewinde MACON

Raccord mâle fixe Macon



ROSCA THREAD	DN	Referencia Part n°	€
M55x3	38	ZRA3125538	*
M55x3	40	ZRA3125540	*
M67x3	50	ZRA3126750	*
M79x3,5	65	ZRA3127965	*
M90x3,5	70	ZRA3129070	*
M90x3,5	80	ZRA3129080	*
M102x4	80	ZRA31210280	*

Macon nuts

Tuercas Macon

Muttern MACON (AISI 316)

Écrous à crans Macon



ROSCA THREAD	DN	Referencia Part n°	€
M55x3	40	ZMAC H 40	24,67
M67x3	50	ZMAC H 50	33,38
M79x3,5	60	ZMAC H 60	40,89
M90x3,5	70	ZMAC H 70	47,08
M102x4	80	ZMAC H 80	56,48
M125x4	100	ZMAC H 100	66,58

FOOD INDUSTRY FITTINGS

Racores industria alimentaria
Kupplungen für Lebensmittelindustrie
Raccords alimentaires

Swivel female SMS for PTFE STD Series

Hembras giratorias prensar SMS para PTFE Serie STD

Dichtkopf mit Ü-Mutter SMS für PTFE Serie STD

Femelle tournante SMS pour PTFE Série STD



ROSCA THREAD	DN	Referencia Part n°	€
40x1/6"	1"	ZRA2504016	62,15
48x1/6"	1" 1/4	ZRA2504820	71,74
60x1/6"	1" 1/2	ZRA2506024	109,95
70x1/6"	2"	ZRA2507032	152,91
85x1/6"	2" 1/2	ZRA2508540	224,11

Swivel female DIN 11851 for PTFE hose STD Series

Hembras giratorias DIN 11851 para PTFE Serie STD

Dichtkopf DIN 11851 für 6 kt-Nippel SMS für PTFE hose Serie STD

Raccord femelle tournante DIN 11851 pour PTFE Série STD

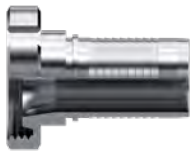

ROSCA THREAD	DN	Referencia Part n°	€
52x1/6"	1"	ZRA1505216	89,72
58x1/6"	1" 1/4	ZRA1505820	125,32
65x1/6"	1" 1/2	ZRA1506524	108,17
78x1/6"	2"	ZRA1507832	159,08
95x1/6"	2" 1/2	ZRA1509540	282,98

Fixed male SMS for PTFE hose STD Series

Machos SMS para PTFE Serie STD

Außengewinde SMS für PTFE Serie STD

Raccord mâle SMS pour PTFE Série STD



ROSCA THREAD	DN	Referencia Part n°	€
40x1/6"	1"	ZRA2524016	62,88
48x1/6"	1" 1/4	ZRA2524820	70,72
60x1/6"	1" 1/2	ZRA2526024	88,83
70x1/6"	2"	ZRA2527032	164,93
85x1/6"	2" 1/2	ZRA2528540	184,14

Fixed male DIN 11851 for PTFE hose STD Series

Machos DIN 11851 para PTFE Serie STD

Außengewinde SMS DIN 11851 für PTFE Serie STD

Raccord mâle DIN 11851 pour PTFE Série STD



ROSCA THREAD	DN	Referencia Part n°	€
52x1/6"	1"	ZRA1525216	88,23
78x1/6"	2"	ZRA1527832	197,92
58x1/6"	1" 1/4	ZRA1525820	92,33
65x1/6"	1" 1/2	ZRA1526524	112,97
95x1/6"	2" 1/2	ZRA1529540	306,46

Tri-Clamp Fittings STD Series

Racores Tri-Clamp Serie STD

Dichtkopf TRI-CLAMP Serie STD

Raccords Tri-Clamp Série STD



∅	DN	Referencia Part n°	€
34	3/8"	ZTCS3406	43,54
50,5	3/4"	ZTCS5012	58,81
50,5	1"	ZTCS5016	59,58
50,5	1" 1/4	ZTCS5020	68,52
50,5	1" 1/2	NEW ZTCS5024	84,07
64	1" 1/2	ZTCS6424	95,75
64	2"	ZTCS6432	124,43
77,5	2"	ZTCS7732	212,67

Ferrules for smooth PTFE

Casquillos PTFE liso

Pressfassungen für PTFE-Glattschläuche

Jupes PTFE lisse



DN	Referencia Part n°	€
1/8"	810400100	*
3/16"	810400300	*
1/4"	810400400	*
5/16"	810400500	*
3/8"	810400600	*
1/2"	810400800	*
5/8"	810401000	*
3/4"	810401200	*
1"	810401600	*

*See prices p.24 / *Ver precios en p.24 / *Vgl. Sie die Preise auf S. 24 / *Voir prix p.24

Ferrules for convoluted PTFE

Casquillos PTFE corrugado

Pressfassungen für PTFE-Wellschläuche mit Umfl.

Jupes PTFE convoluté



DN	Referencia Part n°	€
1/4"	810410400	*
5/16"	810410500	*
3/8"	810410600	*
1/2"	810410800	*
5/8"	810411000	*
3/4"	810411201	*
1"	810411600	*
1" 1/4	810412000	*
1" 1/2	810412400	*
2"	810413200	*
2" 1/2	810414000	*

*See prices p. 24 / *Ver precios en p.24 / *Vgl. Sie die Preise auf S. 24 / *Voir prix p.24

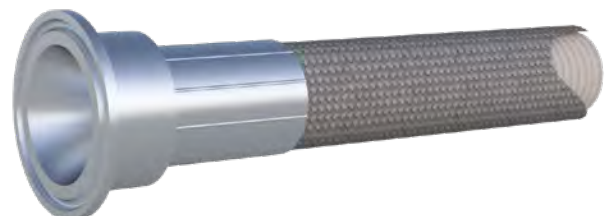
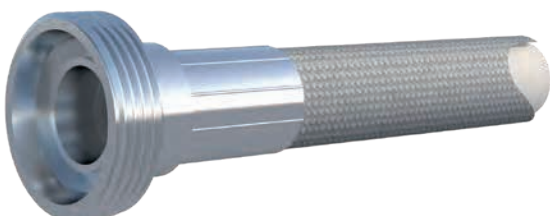

DIN 2828 CAMLOCK FITTINGS

Serie Camlock DIN 2828
CAMLOCK AISI 316 - DIN 2828
Raccords Camlock DIN 2828

Male Camlock coupling, female BSP threaded Type A

Camlock macho - rosca hembra BSP Tipo A

Kupplung BSP Typ A

Adapteur mâle Camlock- filetage femelle BSP Type A



DN	ROSCA THREAD	Referencia Part n°	€
12	1/2"	ZA012	6,72
20	1/2"	ZA015	6,72
20	3/4"	ZA020	9,90
25	1"	ZA025	12,54
32	1"1/4	ZA032	17,00
40	1"1/2	ZA040	23,17
50	2"	ZA050	29,64
65	2"1/2	ZA065	43,92
80	3"	ZA080	55,92
100	4"	ZA100	77,72

Female Camlock coupling, female BSPT threaded Type B

Camlock hembra - rosca macho BSPT Tipo B

Kupplung BSPT TYP B

Adapteur Camlock femelle - filetage mâle BSPT Type B



DN	ROSCA THREAD	Referencia Part n°	€
12	1/2"	ZB012	15,48
20	1/2"	ZB015	15,47
20	3/4"	ZB020	16,25
25	1"	ZB025	21,29
32	1"1/4	ZB032	31,71
40	1"1/2	ZB040	32,13
50	2"	ZB050	45,42
65	2"1/2	ZB065	58,43
80	3"	ZB080	82,05
100	4"	ZB100	116,67

Female Camlock coupling with serrated hose shank Type C

Camlock hembra - para manguera Tipo C

Schlauch-Kupplung TYP C

Coupleur Camlock femelle - pour tuyau Type C



DN	ROSCA THREAD	Referencia Part n°	€
12	1/2"	ZC012	13,70
20	1/2"	ZC015	14,68
20	3/4"	ZC020	16,82
25	1"	ZC025	22,71
32	1"1/4	ZC032	33,14
40	1"1/2	ZC040	36,63
50	2"	ZC050	46,50
65	2"1/2	ZC065	62,12
80	3"	ZC080	101,92
100	4"	ZC100	128,64

Female Camlock coupling, female BSP threaded Type D

Camlock hembra - rosca hembra BSP Tipo D

Kupplung BSP TYP D

Adapteur Camlock femelle BSP Type D



DN	ROSCA THREAD	Referencia Part n°	€
12	1/2"	ZD012	14,18
20	1/2"	ZD015	15,00
20	3/4"	ZD020	16,48
25	1"	ZD025	22,71
32	1"1/4	ZD032	34,55
40	1"1/2	ZD040	34,03
50	2"	ZD050	47,54
65	2"1/2	ZD065	59,37
80	3"	ZD080	84,42
100	4"	ZD100	121,55

Male Camlock coupling, with serrated hose shank Type E

Camlock macho - para manguera Tipo E

Schlauch-Kupplung TYP E

Coupleur Camlock mâle Type E



DN	ROSCA THREAD	Referencia Part n°	€
12	1/2"	ZE012	6,97
20	1/2"	ZE015	7,05
20	3/4"	ZE020	9,50
25	1"	ZE025	14,23
32	1"1/4	ZE032	21,08
40	1"1/2	ZE040	27,11
50	2"	ZE050	37,20
65	2"1/2	ZE065	53,30
80	3"	ZE080	86,13
100	4"	ZE100	114,17

Male Camlock coupling, male BSPT threaded Type F

Camlock macho - rosca macho BSPT Tipo F

Kupplung BSPT TYP F

Adapteur Camlock mâle BSPT Type F



DN	ROSCA THREAD	Referencia Part n°	€
12	1/2"	ZF012	7,97
20	1/2"	ZF015	8,07
20	3/4"	ZF020	9,80
25	1"	ZF025	13,68
32	1"1/4	ZF032	18,49
40	1"1/2	ZF040	28,62
50	2"	ZF050	33,28
65	2"1/2	ZF065	52,31
80	3"	ZF080	66,66
100	4"	ZF100	108,68

DIN 2828 CAMLOCK FITTINGS

Serie Camlock DIN 2828
CAMLOCK AISI 316 - DIN 2828
Raccords Camlock DIN 2828

Female Camlock Coupling-Dust caps Type DC

Camlock hembra - tapón Tipo DC

Verschluss TYP DC

Bouchon Camlock femelle Type DC



DN	Referencia Part n°	€
12	ZDC012	13,22
20	ZDC020	15,76
25	ZDC025	20,43
32	ZDC032	32,28
40	ZDC040	31,19
50	ZDC050	40,36
65	ZDC065	53,18
80	ZDC080	69,09
100	ZDC100	97,94

Male Camlock coupling-Dust plugs Type DP

Camlock macho - tapón tipo DP

Verschluss TYP DP

Bouchon Camlock mâle Type DP



DN	Referencia Part n°	€
12	ZDP012	6,05
20	ZDP020	7,39
25	ZDP025	9,86
32	ZDP032	14,68
40	ZDP040	16,63
50	ZDP050	23,79
65	ZDP065	40,33
80	ZDP080	48,68
100	ZDP100	77,18

Camlock NBR Seal

Junta Camlock NBR

NBR-Dichtringe für CAMLOCK

Joint Camlock NBR



DN	Referencia Part n°	€
12	JCAMNBR012	0,89
20	JCAMNBR020	0,89
25	JCAMNBR025	1,55
32	JCAMNBR032	1,86
40	JCAMNBR040	2,01
50	JCAMNBR050	3,22
65	JCAMNBR065	4,17
80	JCAMNBR080	3,68
100	JCAMNBR100	6,29

Camlock male - weldable BW

Camlock macho - soldable BW

Kupplung - schweißbar BW

Adapteur Camlock mâle à souder BW



NEW

TUBO PIPE	Referencia Part n°	€
21.3	ZABW012	15,47
26.9	ZABW020	16,25
33.7	ZABW025	22,47
42.4	ZABW032	33,47
48.3	ZABW040	33,92
60.3	ZABW050	47,94

Camlock female - weldable BW

Camlock hembra - soldable BW

Kupplung - schweißbar BW

Adapteur Camlock femelle à souder BW



NEW

TUBO PIPE	Referencia Part n°	€
21.3	ZDBW012	7,97
26.9	ZDBW020	9,80
33.7	ZDBW025	13,68
42.4	ZDBW032	18,49
48.3	ZDBW040	28,62
60.3	ZDBW050	33,28

Camlock silicone seal

Junta Camlock silicona

Silikon-Dichtring CAMLOCK

Joint Camlock silicone

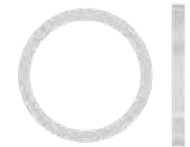

DN	Referencia Part n°	€
12	JCAMSO12	2,38
20	JCAMSO20	2,38
25	JCAMSO25	2,83
32	JCAMSO32	4,49
40	JCAMSO40	6,03
50	JCAMSO50	6,79
65	JCAMSO65	7,86
80	JCAMSO80	11,74
100	JCAMSO100	15,71

DIN 2828 CAMLOCK FITTINGS

Serie Camlock DIN 2828
CAMLOCK AISI 316 - DIN 2828
Raccords Camlock DIN 2828

Male Camlock coupling, female NPT threaded Type A

Camlock macho - rosca hembra NPT Tipo A

Kupplung NPT Typ A

Adapteur Camlock mâle - filetage femelle NPT Type A



DN	ROSCA THREAD	Referencia Part n°	€
12	1/2"	ZA012NPT	6,72
20	3/4"	ZA020NPT	10,45
25	1"	ZA025NPT	13,24
32	1" 1/4	ZA032NPT	17,00
40	1" 1/2	ZA040NPT	23,17
50	2"	ZA050NPT	31,28
65	2" 1/2	ZA065NPT	43,92
80	3"	ZA080NPT	55,92
100	4"	ZA100NPT	79,30

Female Camlock Coupling, female NPT threaded Type B

Camlock hembra - rosca macho NPT Tipo B

Kupplung NPT Typ B

Adapteur Camlock femelle - filetage mâle NPT Type B



DN	ROSCA THREAD	Referencia Part n°	€
12	1/2"	ZB012NPT	15,17
20	3/4"	ZB020NPT	15,40
25	1"	ZB025NPT	21,29
32	1" 1/4	ZB032NPT	31,71
40	1" 1/2	ZB040NPT	32,13
50	2"	ZB050NPT	45,42
65	2" 1/2	ZB065NPT	58,43
80	3"	ZB080NPT	82,05
100	4"	ZB100NPT	116,67

Female Camlock Coupling, female NPT threaded Type D

Camlock hembra - rosca hembra NPT Tipo D

Kupplung NPT Typ D

Adapteur Camlock femelle NPT Type D



DN	ROSCA THREAD	Referencia Part n°	€
12	1/2"	ZD012NPT	14,18
20	3/4"	ZD020NPT	16,48
25	1"	ZD025NPT	22,71
32	1" 1/4	ZD032NPT	34,55
40	1" 1/2	ZD040NPT	34,03
50	2"	ZD050NPT	47,54
65	2" 1/2	ZD065NPT	59,37
80	3"	ZD080NPT	84,42
100	4"	ZD100NPT	121,55

Male Camlock coupling, male NPT threaded Type F

Camlock macho - rosca macho NPT Tipo F

Kupplung NPT Typ F

Adapteur Camlock mâle NPT Type F



DN	ROSCA THREAD	Referencia Part n°	€
12	1/2"	ZF012NPT	7,97
20	3/4"	ZF020NPT	9,80
25	1"	ZF025NPT	13,68
32	1" 1/4	ZF032NPT	18,49
40	1" 1/2	ZF040NPT	28,62
50	2"	ZF050NPT	33,28
65	2" 1/2	ZF065NPT	52,31
80	3"	ZF080NPT	66,66
100	4"	ZF100NPT	108,68

CAMLOCK NPT



EN 14420-7 | DIN 2828

Ver ficha técnica | Check technical sheet

Para una amplia gama de aplicaciones como agua petróleo y productos químicos
For a wide range of applications such as water, petroleum and chemical liquids

DIN 2828 CAMLOCK FITTINGS

Serie Camlock DIN 2828
CAMLOCK AISI 316 - DIN 2828
Raccords Camlock DIN 2828

Autolock, female, BSP male threaded Type B

Autolock hembra - rosca macho BSP Tipo B

Autolock Sicherheit TYP B

Autolock femelle - filetage mâle BSP Type B



DN	ROSCA THREAD	Referencia Part n°	€
12	1/2"	ZB012S	29,06
20	3/4"	ZB020S	24,72
25	1"	ZB025S	35,40
32	1"1/4	ZB032S	56,82
40	1"1/2	ZB040S	66,31
50	2"	ZB050S	79,60
65	2"1/2	ZB065S	109,38
80	3"	ZB080S	151,01
100	4"	ZB100S	200,01

Autolock, female, BSP female threaded Type D

Autolock hembra - rosca hembra BSP Tipo D

Autolock Sicherheit TYP D

Autolock femelle - filetage femelle BSP Type D



DN	ROSCA THREAD	Referencia Part n°	€
12	1/2"	ZD012S	26,10
20	3/4"	ZD020S	26,10
25	1"	ZD025S	38,32
32	1"1/4	ZD032S	57,77
40	1"1/2	ZD040S	68,21
50	2"	ZD050S	82,80
65	2"1/2	ZD065S	108,54
80	3"	ZD080S	148,17
100	4"	ZD100S	208,19

Autolock, female, with serrated hose shank Type C

Autolock hembra - para manguera Tipo C

Autolock Sicherheit TYP C

Autolock femelle - pour tuyau Type C



DN	ROSCA THREAD	Referencia Part n°	€
12	1/2"	ZC012S	30,55
20	3/4"	ZC020S	29,66
25	1"	ZC025S	41,04
32	1"1/4	ZC032S	59,55
40	1"1/2	ZC040S	69,28
50	2"	ZC050S	87,31
65	2"1/2	ZC065S	122,07
80	3"	ZC080S	167,15
100	4"	ZC100S	235,48

Autolock, female, DC type dust cap

Autolock hembra - tapón Tipo DC

Autolock Sicherheit TYP DC

Autolock femelle - bouchon Type DC



DN	Referencia Part n°	€
12	ZDC012S	25,65
20	ZDC020S	25,65
25	ZDC025S	33,81
32	ZDC032S	53,03
40	ZDC040S	58,84
50	ZDC050S	74,97
65	ZDC065S	94,78
80	ZDC080S	123,97
100	ZDC100S	166,43

AUTOLOCK

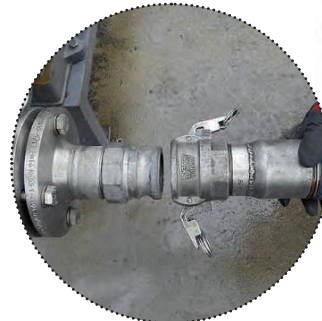

Camlock con cierre de seguridad, múltiples aplicaciones como agua, petróleo y productos químicos

Camlock with security lock, for multiple applications such as water, petroleum and chemical liquids

Ver ficha técnica | Check technical sheet

GUILLEMIN NF E-29572 FITTINGS

Acoples GUILLEMIN NF E-29572
Kupplungen GUILLEMIN NF E-29572
Raccords GUILLEMIN NF E-29572

GUILLEMIN S.S. with closure-BSP Female thread

GUILLEMIN con cierre-rosca hembra BSP

GUILLEMIN Innengewinde BSP mit Verschluss

GUILLEMIN Inox avec fermeture-Filetage Femelle BSP



DN	ROSCA THREAD	Referencia Part n°	€
20	3/4"	ZGU01C020	26,93
25	1"	ZGU01C025	37,03
32	1" 1/4	ZGU01C032	43,76
40	1" 1/2	ZGU01C040	70,70
50	2"	ZGU01C050	70,70
65	2" 1/2	ZGU01C065	97,63
80	3"	ZGU01C080	144,76
100	4"	ZGU01C100	245,75

GUILLEMIN S.S. with closure-BSP Male thread

GUILLEMIN con cierre-rosca macho BSP

GUILLEMIN Außengewinde BSP mit Verschluss

GUILLEMIN Inox avec fermeture-Filetage Mâle BSP



DN	ROSCA THREAD	Referencia Part n°	€
20	3/4"	ZGU02C020	20,20
25	1"	ZGU02C025	23,57
32	1" 1/4	ZGU02C032	30,30
40	1" 1/2	ZGU02C040	43,76
50	2"	ZGU02C050	73,00
65	2" 1/2	ZGU02C065	97,63
80	3"	ZGU02C080	148,13
100	4"	ZGU02C100	178,42

GUILLEMIN S.S. with closure-Plug

GUILLEMIN con cierre-tapón

GUILLEMIN Verschlussstopfen mit Verschluss

GUILLEMIN Inox avec fermeture-Bouchon



DN	Referencia Part n°	€
20	ZGU04C020	20,20
25	ZGU04C025	20,20
32	ZGU04C032	30,30
40	ZGU04C040	37,03
50	ZGU04C050	50,50
65	ZGU04C065	67,33
80	ZGU04C080	97,63
100	ZGU04C100	168,32

GUILLEMIN S.S. without closure-BSP Female thread

GUILLEMIN sin cierre-rosca hembra BSP

GUILLEMIN Innengewinde BSP ohne Verschluss

GUILLEMIN Inox sans fermeture-Filetage Femelle BSP



DN	ROSCA THREAD	Referencia Part n°	€
20	3/4"	ZGU01S020	16,83
25	1"	ZGU01S025	16,83
32	1" 1/4	ZGU01S032	23,57
40	1" 1/2	ZGU01S040	33,66
50	2"	ZGU01S050	37,03
65	2" 1/2	ZGU01S065	50,50
80	3"	ZGU01S080	84,16
100	4"	ZGU01S100	97,63

GUILLEMIN S.S. without closure-BSP Male thread

GUILLEMIN sin cierre-rosca macho BSP

GUILLEMIN Außengewinde BSP ohne Verschluss

GUILLEMIN Inox sans fermeture-Filetage Mâle BSP



DN	ROSCA THREAD	Referencia Part n°	€
20	3/4"	ZGU02S020	16,83
25	1"	ZGU02S025	20,20
32	1" 1/4	ZGU02S032	25,92
40	1" 1/2	ZGU02S040	25,92
50	2"	ZGU02S050	43,76
65	2" 1/2	ZGU02S065	53,86
80	3"	ZGU02S080	105,87
100	4"	ZGU02S100	111,09

GUILLEMIN S.S. with closure-Reducer

GUILLEMIN con cierre-reductor

GUILLEMIN Reduzierstück mit Verschluss

GUILLEMIN Inox avec fermeture-Réduction



DN	Referencia Part n°	€
40-32	ZGU03C040032	134,66
50-40	ZGU03C050040	134,66
65-50	ZGU03C065050	171,69
80-65	ZGU03C080065	259,22
100-80	ZGU03C100080	336,65

GUILLEMIN NF E-29572 FITTINGS

Acoples GUILLEMIN NF E-29572
Kupplungen GUILLEMIN NF E-29572
Raccords GUILLEMIN NF E-29572

GUILLEMIN S.S. with closure-For hose

GUILLEMIN con cierre-para manguera

GUILLEMIN Für Schlauch mit Verschluss

GUILLEMIN Inox avec fermeture-Pour tuyau



DN	L (mm)	TAMAÑO SIZE	Referencia Part n°	€
40	37	40	ZGU05C040040	37,62
45	37	40	ZGU05C040045	43,76
50	48	50	ZGU05C050050	77,43
50	45,5	50	ZGU05C050055	77,43
65	50	65	ZGU05C065065	104,36
80	70	80	ZGU05C080080	178,42

GUILLEMIN S.S. with closure-Welding

GUILLEMIN con cierre-soldable

GUILLEMIN Schweißarmaturen mit Verschluss

GUILLEMIN Inox avec fermeture-À souder



DN	Referencia Part n°	€
40	ZGU06C040040	43,76
50	ZGU06C050050	71,71
65	ZGU06C065065	97,63
80	ZGU06C080080	148,13

GUILLEMIN



EN 14420-8 | NF E-29572

Ver ficha técnica | Check technical sheet

Aplicaciones de presión y aspiración en un amplio rango de industrias

Pressure and suction purposes in a wide range of industries

TW (TANKWAGEN) DIN 28450 FITTINGS

Acoples TW (Tankwagen) DIN 28450
Kupplungen TW (Tankwagen) DIN 28450
Raccords TW (Tankwagen) DIN 28450

TW BSP Female thread - female coupling

TW rosca hembra BSP - acople hembra

TW Innengewinde BSP - Innengewinde Kupplung

TW Filetage Femelle BSP - accouplement Femelle



DN	Referencia Part n°	€
2"	ZMK05032	74,58
3"	ZMK08048	135,08
4"	ZMK10064	265,24

TW BSP Female thread - male coupling

TW rosca hembra BSP - acople macho

TW Innengewinde BSP - Außengewinde Kupplung

TW Filetage Femelle BSP - accouplement Mâle



DN	∅	Referencia Part n°	€
2"	70.5	ZVK05032	34,44
3"	102	ZVK08048	71,02
4"	128	ZVK10064	99,74

TW cap coupling

TW tapón - acople hembra

TW Verschlusskupplung w

TW Bouchon - accouplement Femelle



DN	Referencia Part n°	€
2"	ZMB050	31,98
3"	ZMB080	64,20
4"	ZMB100	108,97

TW Plug - male coupling

TW tapón - acople macho

TW Verschlusskupplung m

TW Bouchon - accouplement Mâle



DN	∅	Referencia Part n°	€
2"	70.5	ZVB050	29,02
3"	102	ZVB080	51,71
4"	128	ZVB100	82,18

TW Female coupling

TW acople hembra

TW Schweißarmaturen - Innengewinde-Kupplung

TW Accouplement Femelle



DN	Referencia Part n°	€
2"	ZMKS050050	97,08
3"	ZMKS080080	205,72

TW Male coupling

TW acople macho

TW Schweissarmaturen muss glaube ich weg

TW Accouplement Mâle



DN	Referencia Part n°	€
2"	ZVKS050050	62,28
3"	ZVKS080080	145,95

STAINLESS STEEL ACCESSORIES FOR INDUSTRIAL FITTING

Accesorios inox para racor industrial
Edelstahl-Zubehör für Industriekupplungen
Accessoires acier inox pour raccord industriel

Stainless Steel Crimping Ferrule 45° closure

Campana inox para racor industrial - cierre 45°

Edelstahl-Hülse 45°Verschluss

Jupe pour raccord industriel acier inox -fermeture 45°



DN	Ø INT. Ø INNER	Referencia Part n°	€
25	42.5	ZCA025	6,88
32	47	ZCA032	9,71
40	55	ZCA040	10,08
50	64	ZCA050	15,57
50	68	ZCA05001	31,68
65	79	ZCA065	32,94
80	98	ZCA080	38,74
100	120	ZCA100	74,58

Stainless Steel clamp for industrial fitting EN14420-3

Abrazadera EN 14420-3 inox para racor industrial

Edelstahl-Schelle EN14420-3 für Industriekupplungen

Collier pour raccord industriel acier inox EN 14420-3



Ø MANGUERA Ø HOSE	Ø INT. Ø INNER	Referencia Part n°	€
12	21-25	ZAB01021025	19,82
19	29-33	ZAB01029033	24,68
25	35-39	ZAB01035039	28,49
32	42-46	ZAB01042046	29,26
38	47-51	ZAB01047051	32,74
38	49-53	ZAB01049053	32,74
38	52-56	ZAB01052056	31,20
38	58-62	ZAB01058062	29,35
50	60-64	ZAB01060064	47,04
50	63-67	ZAB01063067	54,17
50	68-72	ZAB01068072	57,37
63	74-77	ZAB01074077	62,43
63	77-81	ZAB01077081	78,93
75	87-90	ZAB01087090	95,30
80	89-94	ZAB01089094	93,10
80	94-98	ZAB01094098	85,36
100	114-119	ZAB01114119	223,02

Stainless steel high pressure clamp W4

Abrazadera alta presión W4 inox

Edelstahl-Hochdruck-Schelle W4 Stahl

Collier haute pression W4 acier inox.



Ø INT. Ø INNER	Referencia Part n°	€
17-19	ZAB02017019	4,00
20-22	ZAB02020022	4,06
23-25	ZAB02023025	4,13
26-28	ZAB02026028	4,18
29-31	ZAB02029031	5,08
32-35	ZAB02032035	5,20
36-39	ZAB02036039	5,26
40-43	ZAB02040043	5,33
44-47	ZAB02044047	5,83
48-51	ZAB02048051	5,96
52-55	ZAB02052055	6,15
56-59	ZAB02056059	6,28
60-63	ZAB02060063	6,41
64-67	ZAB02064067	6,53
68-73	ZAB02068073	8,44
74-79	ZAB02074079	8,69
80-85	ZAB02080085	8,88
86-91	ZAB02086091	9,13
92-97	ZAB02092097	9,33
98-103	ZAB02098103	9,71
104-112	ZAB02104112	9,89
113-121	ZAB02113121	10,15
122-130	ZAB02122130	11,70
131-139	ZAB02131139	13,82
140-148	ZAB02140148	14,08
149-161	ZAB02149161	14,27
162-174	ZAB02162174	16,50
175-187	ZAB02175187	15,29
188-200	ZAB02188200	15,67

SCREW LOW PRESSURE FITTINGS 150 LBS

Racores baja presión 150 LBS
Niederdruck-Armaturen 150 lbs
Raccords basse pression 150 LBS

Nipple fixed male fig.399

Macho fijo espiga FIG.399

Außengewinde Dichtkopf FIG.399 fest

Mâle fixe nipple fig. 399 inox



ROSCA THREAD	DN	Referencia Part n°	€
1/4"	10	ZFIG39904	3,14
3/8"	12	ZFIG39906	3,70
1/2"	15	ZFIG39908	4,87
3/4"	20	ZFIG39912	7,70
1"	25	ZFIG39916	11,95
1" 1/4	32	ZFIG39920	17,31
1" 1/2	40	ZFIG39924	22,92
2"	52	ZFIG39932	37,58

Union male-male fig.150

Unión macho-macho FIG.150

Gerade Verschraubung Fig. 150

Union mâle-mâle fig.150 inox



ROSCA THREAD	Referencia Part n°	€
1/4"	ZFIG15004	2,28
3/8"	ZFIG15006	2,71
1/2"	ZFIG15008	4,07
3/4"	ZFIG15012	5,05
1"	ZFIG15016	6,84
1" 1/4	ZFIG15020	10,96
1" 1/2	ZFIG15024	12,75
2"	ZFIG15032	22,30

Hexagon male plug FIG.290

Tapón macho hexagonal FIG.290

6 kt Stopfen Fig. 290

Bouchon mâle 150 LBS tête hexagonale FIG.290



ROSCA THREAD	Referencia Part n°	€
1/8"	ZFIG29002	1,85
1/4"	ZFIG29004	2,16
3/8"	ZFIG29006	2,77
1/2"	ZFIG29008	3,02
3/4"	ZFIG29012	4,87
1"	ZFIG29016	6,96
1"1/4	ZFIG29020	9,42
1"1/2	ZFIG29024	12,32
2"	ZFIG29032	19,03
2"1/2	ZFIG29040	29,88
3"	ZFIG29048	48,11
4"	ZFIG29060	72,20

Hexagon nipple FIG.280

Adaptador hexagonal FIG.280

6 kt Doppelnippel fig. 280

Mamelon hexagonal 150 LBS FIG.280



ROSCA THREAD	Referencia Part n°	€
1/4"	ZFIG28004	2,16
3/8"	ZFIG28006	2,71
1/2"	ZFIG28008	4,31
3/4"	ZFIG28012	6,22
1"	ZFIG28016	9,61
1"1/4	ZFIG28020	12,01
1"1/2	ZFIG28024	16,76
2"	ZFIG28032	28,89
2"1/2	ZFIG28040	48,29
3"	ZFIG28048	65,11
4"	ZFIG28060	93,32

Reducer male-male fig. 245

Reducción macho-macho FIG.245

Reduziernippel FIG.245

Réduction mâle-mâle fig. 245 inox



THREAD	ROSCA THREAD	THREAD	Referencia Part n°	€
1/4"	1/8"	1/8"	ZFIG2450402	2,16
3/8"	1/4"	1/4"	ZFIG2450604	2,65
1/2"	1/4"	1/4"	ZFIG2450804	3,33
1/2"	3/8"	3/8"	ZFIG2450806	3,45
3/4"	3/8"	3/8"	ZFIG2451206	4,80
3/4"	1/2"	1/2"	ZFIG2451208	5,67
1"	1/2"	1/2"	ZFIG2451608	8,19
1"	3/4"	3/4"	ZFIG2451612	7,70
1" 1/4	3/4"	3/4"	ZFIG2452012	9,86
1" 1/4	1"	1"	ZFIG2452016	11,58
1" 1/2	1"	1"	ZFIG2452416	14,11
1"1/2	1" 1/4	1" 1/4	ZFIG2452420	14,11
2"	1" 1/4	1" 1/4	ZFIG2453220	19,28
2"	1" 1/2	1" 1/2	ZFIG2453224	21,87
2" 1/2	2"	2"	ZFIG2454032	36,28
3"	2" 1/2	2" 1/2	ZFIG2454840	57,84

Flat nut fig.312

Tuerca plana FIG.312

Flachmutter FIG. 312

Écrou plat fig.312 inox



ROSCA THREAD	Referencia Part n°	€
1/4"	ZFIG31204	1,85
3/8"	ZFIG31206	2,03
1/2"	ZFIG31208	2,16
3/4"	ZFIG31212	2,90
1"	ZFIG31216	3,63
1" 1/4	ZFIG31220	5,42
1" 1/2	ZFIG31224	7,33
2"	ZFIG31232	10,90

SCREW LOW PRESSURE FITTINGS 150 LBS

Racores baja presión 150 LBS
Niederdruck-Armaturen 150 lbs
Raccords basse pression 150 LBS

Hexagon female cap. FIG.300

Tapón hembra hexagonal FIG.300

6 kt Verschluss m. rd. fig. 300

Bouchon femelle hexagonal 150 LBS FIG.300



ROSCA THREAD	Referencia Part n°	€
1/8"	ZFIG30002	2,34
1/4"	ZFIG30004	2,71
3/8"	ZFIG30006	2,90
1/2"	ZFIG30008	4,00
3/4"	ZFIG30012	5,73
1"	ZFIG30016	8,19
1"1/4	ZFIG30020	12,07
1"1/2	ZFIG30024	13,43
2"	ZFIG30032	20,02
2"1/2	ZFIG30040	31,11
3"	ZFIG30048	45,34
4"	ZFIG30060	83,16

BSP Female coupling DIN 2986 FIG.270

Adaptador hembra BSP DIN 2986 FIG.270

Muffen DIN 2986 Fig. 270

Manchon femelle gaz DIN 2986 150 LBS FIG.270



ROSCA THREAD	Referencia Part n°	€
1/4"	ZFIG27004	3,14
3/8"	ZFIG27006	3,51
1/2"	ZFIG27008	5,17
3/4"	ZFIG27012	5,05
1"	ZFIG27016	9,73
1"1/4	ZFIG27020	13,18
1"1/2	ZFIG27024	15,28
2"	ZFIG27032	21,38
2"1/2	ZFIG27040	37,08
3"	ZFIG27048	49,83
4"	ZFIG27060	83,28

Male square plug FIG.291

Tapón macho cuadrado FIG.291

4 kt Stopfen Fig.291

Bouchon mâle 150 LBS tête carrée FIG.291



ROSCA THREAD	Referencia Part n°	€
1/8"	ZFIG29102	1,85
1/4"	ZFIG29104	1,97
3/8"	ZFIG29106	2,28
1/2"	ZFIG29108	2,71
3/4"	ZFIG29112	3,94
1"	ZFIG29116	5,54
1"1/4	ZFIG29120	7,95
1"1/2	ZFIG29124	9,67
2"	ZFIG29132	15,52
2"1/2	ZFIG29140	21,50
3"	ZFIG29148	33,51
4"	ZFIG29160	57,41

Round female cap. FIG.301

Tapón hembra redondo FIG.301

Verschluss Fig.301

Bouchon femelle ronde 150 LBS FIG.301



ROSCA THREAD	Referencia Part n°	€
1/8"	ZFIG30102	2,34
1/4"	ZFIG30104	2,46
3/8"	ZFIG30106	2,46
1/2"	ZFIG30108	3,45
3/4"	ZFIG30112	4,56
1"	ZFIG30116	7,15
1"1/4	ZFIG30120	9,75
1"1/2	ZFIG30124	11,09
2"	ZFIG30132	17,31
2"1/2	ZFIG30140	26,24
3"	ZFIG30148	42,01
4"	ZFIG30160	71,89

Until end of stock / Hasta fin de existencias / Bis zum Ende des Lagerbestandes / Jusqu'à la fin du stock

Male-female reducer FIG.241

Reductor macho-hembra FIG.241

Reduzierstück m-w Fig. 241

Réduction 150 LBS MG - FG FIG.241



ROSCA THREAD	ROSCA THREAD	Referencia Part n°	€
1/8"	1/4"	ZFIG2410204	2,22
1/4"	3/8"	ZFIG2410406	2,34
1/4"	1/2"	ZFIG2410408	3,45
3/8"	1/2"	ZFIG2410608	3,02
1/2"	3/4"	ZFIG2410812	4,50
3/4"	1"	ZFIG2411216	6,90
1"	1"1/4	ZFIG2411620	10,78
1"	1"1/2	ZFIG2411624	14,78
1"1/4	1"1/2	ZFIG2412024	11,46
1"1/2	2"	ZFIG2412432	20,39
2"	2"1/2	ZFIG2413240	35,42
2"1/2	3"	ZFIG2414048	50,76
3"	4"	ZFIG2414860	80,70

Threaded pipe fig. 531

Tubo roscado FIG.531

Drehstutzen FIG. 531

Tube fileté fig. 531 inox



ROSCA THREAD	Referencia Part n°	€
1/4"	ZFIG53104	3,33
3/8"	ZFIG53106	3,70
1/2"	ZFIG53108	3,22
3/4"	ZFIG53112	3,83
1"	ZFIG53116	5,68
1"1/4	ZFIG53120	7,53
1"1/2	ZFIG53124	8,69
2"	ZFIG53132	13,49

SCREW LOW PRESSURE FITTINGS 150 LBS

Racores baja presión 150 LBS
Niederdruck-Armaturen 150 lbs
Raccords basse pression 150 LBS

Female-female Reducer socket FIG.240

Reducción hembra-hembra FIG.240

Weiblich-weiblich Reduktion Muffen Fig.240

Réduction Femelle-femelle 150 LBS FIG.240



THREAD	ROSCA	THREAD	Referencia Part n°	€
1/4"		1/8"	ZFIG2400402	2,40
3/8"		1/4"	ZFIG2400604	3,14
1/2"		3/8"	ZFIG2400806	4,37
3/4"		1/2"	ZFIG2401208	6,53
1"		3/4"	ZFIG2401612	8,87
1"1/4		1"	ZFIG2402016	13,31
1"1/2		1"1/4	ZFIG2402420	17,37
2"		1"1/2	ZFIG2403224	19,34
2"1/2		2"	ZFIG2404032	36,96
3"		2"	ZFIG2404832	53,10
3"		2"1/2	ZFIG2404840	56,67
4"		2"	ZFIG2406032	69,44

Male-female elbow 90° FIG.092

Codo 90° macho-hembra FIG.092

90° Bogen M - FIG. 092

CoUDE 90° 150 LBS MG - FG FIG.092



ROSCA THREAD	Referencia Part n°	€
1/8"	ZFIG09202	3,02
1/4"	ZFIG09204	3,63
3/8"	ZFIG09206	4,07
1/2"	ZFIG09208	5,79
3/4"	ZFIG09212	8,01
1"	ZFIG09216	12,38
1"1/4	ZFIG09220	16,26
1"1/2	ZFIG09224	22,36
2"	ZFIG09232	33,82
2"1/2	ZFIG09240	64,00
3"	ZFIG09248	107,12
4"	ZFIG09260	195,27

Female-female elbow 90° FIG.090

Codo 90° hembra-hembra FIG.090

90° Winkel 150 lbs FIF. 090

CoUDE 90° 150 LBS femelle gaz FIG.090



ROSCA THREAD	Referencia Part n°	€
1/8"	ZFIG09002	2,22
1/4"	ZFIG09004	2,71
3/8"	ZFIG09006	3,51
1/2"	ZFIG09008	4,74
3/4"	ZFIG09012	7,39
1"	ZFIG09016	10,60
1"1/4	ZFIG09020	15,71
1"1/2	ZFIG09024	21,50
2"	ZFIG09032	32,77
2"1/2	ZFIG09040	61,29
3"	ZFIG09048	94,06
4"	ZFIG09060	168,29

Female-female TEE FIG.130

TE hembra-hembra-hembra FIG.130

Weiblich-weiblich T-Stück 150 lbs FIG. 130

TÉS 150 LBS FG - FG - FG FIG.130



ROSCA THREAD	Referencia Part n°	€
1/8"	ZFIG13002	2,77
1/4"	ZFIG13004	3,67
3/8"	ZFIG13006	4,62
1/2"	ZFIG13008	6,59
3/4"	ZFIG13012	10,04
1"	ZFIG13016	14,23
1"1/4	ZFIG13020	20,33
1"1/2	ZFIG13024	27,72
2"	ZFIG13032	42,32
2"1/2	ZFIG13040	79,40
3"	ZFIG13048	115,87
4"	ZFIG13060	226,63

Female-female elbow 45° FIG.120

Codo 45° hembra-hembra FIG.120

45° Winkel 150 lbs fig.120

CoUDE 45° 150 LBS FG - FG FIG.120



ROSCA THREAD	Referencia Part n°	€
1/8"	ZFIG12002	3,02
1/4"	ZFIG12004	3,51
3/8"	ZFIG12006	4,19
1/2"	ZFIG12008	5,54
3/4"	ZFIG12012	8,07
1"	ZFIG12016	10,72
1"1/4	ZFIG12020	17,19
1"1/2	ZFIG12024	22,48
2"	ZFIG12032	32,59
2"1/2	ZFIG12040	55,81
3"	ZFIG12048	83,84
4"	ZFIG12060	146,12

Threaded cross FIG.180

Cruz roscada FIG.180

Gewinde-Kreuzstück FIG. 180

Croix égale 150 LBS FG FIG.180



ROSCA THREAD	Referencia Part n°	€
1/8"	ZFIG18002	4,07
1/4"	ZFIG18004	5,54
3/8"	ZFIG18006	6,16
1/2"	ZFIG18008	9,73
3/4"	ZFIG18012	15,40
1"	ZFIG18016	20,27
1"1/4	ZFIG18020	35,79
1"1/2	ZFIG18024	37,27
2"	ZFIG18032	55,19
2"1/2	ZFIG18040	109,40
3"	ZFIG18048	157,76
4"	ZFIG18060	284,16

SCREW LOW PRESSURE FITTINGS 150 LBS

Racores baja presión 150 LBS
Niederdruck-Armaturen 150 lbs
Raccords basse pression 150 LBS

Female-female FIG.340

Unión 3 piezas hembra-hembra FIG.340

3-teilige Verschraubung kon i/i 150 lbs FIG. 340

Union 3 pièces 150 LBS FG - FG FIG.340



ROSCA THREAD	Referencia Part n°	€
1/8"	ZFIG34002	7,02
1/4"	ZFIG34004	9,18
3/8"	ZFIG34006	11,33
1/2"	ZFIG34008	12,44
3/4"	ZFIG34012	18,11
1"	ZFIG34016	23,59
1" 1/4	ZFIG34020	35,05
1" 1/2	ZFIG34024	40,53
2"	ZFIG34032	61,05
2" 1/2	ZFIG34040	97,27
3"	ZFIG34048	134,23
4"	ZFIG34060	200,32

Male-female union FIG.341

Unión 3 piezas macho-hembra FIG.341

3-teilige Verschraubung m - w Fig. 341

Union 3 pièces 150 LBS MG - FG FIG.341

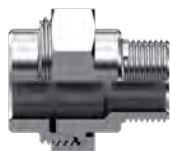

ROSCA THREAD	Referencia Part n°	€
1/4"	ZFIG34104	9,73
3/8"	ZFIG34106	11,83
1/2"	ZFIG34108	13,49
3/4"	ZFIG34112	19,84
1"	ZFIG34116	26,30
1" 1/4	ZFIG34120	38,81
1" 1/2	ZFIG34124	46,08
2"	ZFIG34132	70,04
2" 1/2	ZFIG34140	106,57
3"	ZFIG34148	144,14
4"	ZFIG34160	226,56

Welding male fig.149

Macho soldar FIG.149

Schweiß-Außengewinde FIG.149

Mâle à souder fig.149 inox



ROSCA THREAD	Referencia Part n°	€
1/4"	ZFIG14904	1,79
3/8"	ZFIG14906	2,09
1/2"	ZFIG14908	2,65
3/4"	ZFIG14912	3,57
1"	ZFIG14916	4,87
1" 1/4	ZFIG14920	7,27
1" 1/2	ZFIG14924	8,38
2"	ZFIG14932	11,77

Union 3 fem. welding pieces fig.340hs micro-casting

Unión 3 piezas hembra-soldar FIG.340HS microfundido

3-teilige Schweißversch. w FIG. 340S Mikroguss

Union 3 pcs fem. à souder fig.340hs acier moulé



ROSCA THREAD	Referencia Part n°	€
1/4"	ZFIG34004HS	9,24
3/8"	ZFIG34006HS	11,03
1/2"	ZFIG34008HS	13,41
3/4"	ZFIG34012HS	17,80
1"	ZFIG34016HS	24,21
1" 1/4	ZFIG34020HS	35,05
1" 1/2	ZFIG34024HS	40,53
2"	ZFIG34032HS	61,91

Union 3 welding pieces fig. 340s micro-casting

Unión 3 piezas soldar FIG.340S microfundido

3-teilige Schweißversch. FIG. 340s Mikroguss

Union 3 pièces à souder fig. 340s acier moulé



DN	Referencia Part n°	€
1/4"	ZFIG34004S	9,06
3/8"	ZFIG34006S	10,78
1/2"	ZFIG34008S	13,49
3/4"	ZFIG34012S	16,63
1"	ZFIG34016S	22,55
1" 1/4	ZFIG34020S	32,09
1" 1/2	ZFIG34024S	36,59
2"	ZFIG34032S	57,16

Union 3 welding male pieces fig.341ms micro-casting

Unión 3 piezas macho-soldar FIG.341MS microfundido

3-teilige Schweißversch. m FIG. 340ms Mikroguss

Union 3 pcs mâle à souder fig.341ms acier moulé



ROSCA THREAD	Referencia Part n°	€
1/4"	ZFIG34104MS	9,92
3/8"	ZFIG34106MS	11,09
1/2"	ZFIG34108MS	14,04
3/4"	ZFIG34112MS	20,45
1"	ZFIG34116MS	27,04
1" 1/4	ZFIG34120MS	38,81
1" 1/2	ZFIG34124MS	46,08
2"	ZFIG34132MS	71,15

SCREW LOW PRESSURE FITTINGS 150 LBS

Racores baja presión 150 LBS
Niederdruck-Armaturen 150 lbs
Raccords basse pression 150 LBS

Ball-valve low pressure full bore 3 pcs

Válvula esfera paso total baja presión 3 piezas

Niederdruck-KH Voller Durchgang - 3 Teile

Robinet basse pression 2 voies boisseau sphérique
passage total 3 pcs



ROSCA THREAD	Referencia Part n°	€
1/4" BSP	BP2V3P14INOX	30,22
3/8" BSP	BP2V3P38INOX	30,22
1/2" BSP	BP2V3P12INOX	38,34
3/4" BSP	BP2V3P34INOX	47,67
1" BSP	BP2V3P1INOX	65,31
1" 1/4 BSP	BP2V3P114INOX	108,38
1" 1/2 BSP	BP2V3P112INOX	138,06
2" BSP	BP2V3P2INOX	194,11

Ball-valve low pressure full bore 64 Bar

Válvula esfera paso total baja presión 64 Bar

Niederdruck-KH Voller Durchgang - 64 bar

Robinet basse pression 2 voies boisseau sphérique
passage total 64 Bar



ROSCA THREAD	DN	Referencia Part n°	€
1/4" BSP	8	BP2V14INOX	19,00
3/8" BSP	10	BP2V38INOX	19,00
1/2" BSP	15	BP2V12INOX	21,57
3/4" BSP	20	BP2V34INOX	29,95
1" BSP	25	BP2V1INOX	69,64
1" 1/4 BSP	32	BP2V114INOX	63,64
1" 1/2 BSP	40	BP2V112INOX	97,09
2" BSP	50	BP2V2INOX	151,72
2" 1/2 BSP	65	BP2V212INOX	302,15
3" BSP	80	BP2V3INOX	440,49

CONDUCCIONES HIDRÁULICAS Y NEUMÁTICAS

www.dicsaes.com

HYDRAULIC & PNEUMATIC CONNECTORS



CONSULTA EL
CATÁLOGO DE
CONDUCCIONES

REQUEST OUR
CONNECTORS
CATALOGUE

- FLEXIBLES HIDRÁULICOS Δ FLEXIBLE CONNECTORS
- FLEXIBLES INDUSTRIALES Δ INDUSTRIAL FLEXIBLE HOSES & FITTINGS
- TUBO RÍGIDO Δ PIPE CONNECTORS
- ACCESORIOS Δ ACCESSORIES
- CONDUCCIONES NEUMÁTICAS Δ PNEUMATIC CONNECTORS

QUICK COUPLINGS AISI 316 | 243

Enchufes rápidos AISI 316
SVK AISI 316
Coupleurs rapides AISI 316

BALL VALVES AISI 316 | 246

Llaves de paso AISI 316
Kugelhähne AISI 316
Robinets AISI 316

**QUICK COUPLINGS, BALL VALVES AND
SWIVEL FITTINGS AISI 316 TRΔLE | 249**

Racores giratorios AISI 316 TrΔle
Edelstahl-Kupplungen, -Kugelhähne und
-Drehverschraubungen AISI 316 TrΔle
Coupleurs rapides, robinets et raccords tournants
AISI 316 TrΔle



07

ACCESSORIES

Accesorios
Zubehör
Accessoires

QUICK COUPLINGS AISI 316

Enchufes rápidos AISI 316

SVK AISI 316

Coupleurs rapides AISI 316

Quick couplings ▪ Enchufes rápidos ▪ SVK ▪ Quick release couplings

| 243



Z8001/Z8002

Z8201/Z8202

Z8008/Z8009

Z8301/Z8302

Z9001/Z9002

Z7111/Z7112

Z9051/Z9052

Quick couplings TrΔle ▪ Enchufes rápidos TrΔle ▪ SVK TrΔle ▪ Coupleurs rapides TrΔle

| 245



ZB820

ZB800

ZB830

ZB801

ZB811

ZB900

BALL VALVES AISI 316

Llaves de paso AISI 316

Kugelhähne AISI 316

Robinets AISI 316

Ball valves ▪ Llaves de paso ▪ Kugelhähne ▪ Robinets

246



MKH G

MKH_L

MKH_S

MKH G_DN

MKH_L_DN

MKH_S_DN

MK3A-G

2 ways TrΔle ball valve ▪ Llave 2 vías TrΔle ▪ 2-Wege-KH TrΔle ▪ Robinet 2 voies TrΔle

248



ZGB2V

ZGB2V NPT

ZGB2V L

ZGB2V S

3 ways TrΔle ball valve ▪ Llave 3 vías TrΔle ▪ 3-Wege-KH TrΔle ▪ Robinet 3 voies TrΔle

248



ZGB3VH

Handles ▪ Manetas ▪ Handgriff ▪ Leviers

248



Z60013

QUICK COUPLINGS, BALL VALVES AND SWIVEL FITTINGS AISI 316 TRΔLE

Racores giratorios AISI 316 TrΔle
Edelstahl-Kupplungen, -Kugelhähne und -Drehverschraubungen AISI 316 TrΔle
Coupleurs rapides, robinets et raccords tournants AISI 316 TrΔle

Swivel fittings TrΔle ▪ Racores giratorios TrΔle ▪ Drehverschraubungen TrΔle ▪ Raccords tournants TrΔle

| 249



Z GGL

Z GG90

QUICK COUPLINGS AISI 316

Enchufes rápidos AISI 316

SVK AISI 316

Coupleurs rapides AISI 316

Quick coupling ISO 7241-B

Enchufes de punzón ISO 7241-B

SVK nach ISO 7241-B

Coupleurs rapides à clapet ISO 7241-B



ROSCA THREAD	TAMAÑO ISO ISO SIZE	TAMAÑO BG BG SIZE	E. C.	Referencia Part n°	€
1/4" BSP	6,3	1	M	Z800104	43,69
3/8" BSP	10	2	M	Z800106	48,53
1/2" BSP	12,5	3	M	Z800108	58,88
3/4" BSP	20	4	M	Z800112	97,07
1" BSP	25	5	M	Z800116	157,76
1"1/4 BSP	40	7	M	Z800120	515,65
1"1/2 BSP	40	7	M	Z800124	521,76
2" BSP	50	8	M	Z800132	1.000,98
1/4" BSP	6,3	1	H	Z800204	97,07
3/8" BSP	10	2	H	Z800206	109,23
1/2" BSP	12,5	3	H	Z800208	143,45
3/4" BSP	20	4	H	Z800212	212,95
1" BSP	25	5	H	Z800216	298,46
1"1/4 BSP	40	7	H	Z800220	752,26
1"1/2 BSP	40	7	H	Z800224	752,26
2" BSP	50	8	H	Z800232	1.565,22

Quick coupling 7241-A

Enchufes de punzón 7241-A

SVK nach 7241-A

Coupleurs rapides à clapet 7241-A



ROSCA THREAD	TAMAÑO ISO ISO SIZE	TAMAÑO BG BG SIZE	E. C.	Referencia Part n°	€
3/8" BSP	10	2	M	Z820106	46,91
1/2" BSP	12,5	3	M	Z820108	54,65
3/4" BSP	20	4	M	Z820112	94,65
1" BSP	25	5	M	Z820116	157,76
1"1/4 BSP	31,5	6	M	Z820120	376,16
1"1/2 BSP	40	7	M	Z820124	521,76
2" BSP	50	8	M	Z820132	1.000,98
3/8" BSP	10	2	H	Z820206	129,01
1/2" BSP	12,5	3	H	Z820208	117,55
3/4" BSP	20	4	H	Z820212	195,56
1" BSP	25	5	H	Z820216	282,12
1"1/4 BSP	31,5	6	H	Z820220	746,21
1"1/2 BSP	40	7	H	Z820224	940,34
2" BSP	50	8	H	Z820232	1.783,62

Quick screw couplings ISO 14541

Enchufes autoroscantes ISO 14541

SV-Schraubkupplungen ISO 14541

Coupleur rapide à visser filetage ISO 14541



ROSCA THREAD	TAMAÑO ISO ISO SIZE	TAMAÑO BG BG SIZE	E. C.	Referencia Part n°	€
1/4" BSP	6,3	1	M	Z800804	206,29
3/8" BSP	10	2	M	Z800806	125,63
1/2" BSP	12,5	3	M	Z800808	151,65
3/4" BSP	20	4	M	Z800812	250,59
1" BSP	25	5	M	Z800816	327,63
1"1/4 BSP	40	7	M	Z800820	1.231,54
1"1/2 BSP	40	7	M	Z800824	1.231,54
1/4" BSP	6,3	1	H	Z800904	151,10
3/8" BSP	10	2	H	Z800906	109,23
1/2" BSP	12,5	3	H	Z800908	133,49
3/4" BSP	20	4	H	Z800912	212,35
1" BSP	25	5	H	Z800916	283,94
1"1/4 BSP	40	7	H	Z800920	922,13
1"1/2 BSP	40	7	H	Z800924	922,13

Quick coupling free flow 7241-B

Enchufes paso total 7241-B

SVK 7241-B voller Durchgang

Coupleurs rapides passage total 7241-B



ROSCA THREAD	TAMAÑO ISO ISO SIZE	TAMAÑO BG BG SIZE	E. C.	Referencia Part n°	€
1/8" BSP	5	0	M	Z830102	30,02
1/4" BSP	6,3	1	M	Z830104	30,90
3/8" BSP	10	2	M	Z830106	33,60
1/2" BSP	12,5	3	M	Z830108	40,52
3/4" BSP	20	4	M	Z830112	65,23
1" BSP	25	5	M	Z830116	99,55
1"1/4 BSP	40	7	M	Z830120	222,01
1"1/2 BSP	40	7	M	Z830124	222,01
2" BSP	50	8	M	Z830132	837,23
1/8" BSP	5	0	H	Z830202	90,84
1/4" BSP	6,3	1	H	Z830204	84,48
3/8" BSP	10	2	H	Z830206	101,91
1/2" BSP	12,5	3	H	Z830208	117,77
3/4" BSP	20	4	H	Z830212	166,88
1" BSP	25	5	H	Z830216	282,11
1"1/4 BSP	40	7	H	Z830220	433,67
1"1/2 BSP	40	7	H	Z830224	433,67
2" BSP	50	8	H	Z830232	1.395,36

QUICK COUPLINGS AISI 316

Enchufes rápidos AISI 316

SVK AISI 316

Coupleurs rapides AISI 316

Flat face quick coupling ISO16028

Enchufes de válvula plana ISO16028

Flachdichtende Kupplungen

Coupleurs à clapet face plane ISO16028



ROSCA THREAD	TAMAÑO ISO ISO SIZE	TAMAÑO BG BG SIZE	E. C.	Referencia Part n°	€
1/4" BSP	6,3	1	M	Z900104	157,83
3/8" BSP	10	2	M	Z900106	194,81
1/2" BSP	12,5	3	M	Z900108	223,58
3/4" BSP	16	4A	M	Z900112	305,93
1" BSP	19	4	M	Z900116	330,22
1 1/4" BSP	25	5	M	Z900120	323,94
1 1/2" BSP	38	7	M	Z900124	650,54
2" BSP	51	8	M	Z900132	1.452,08
1/4" BSP	6,3	1	H	Z900204	265,58
3/8" BSP	10	2	H	Z900206	315,47
1/2" BSP	12,5	3	H	Z900208	370,33
3/4" BSP	16	4A	H	Z900212	454,39
1" BSP	19	4	H	Z900216	545,83
1 1/4" BSP	25	5	H	Z900220	796,56
1 1/2" BSP	38	7	H	Z900224	1.577,33
2" BSP	51	8	H	Z900232	2.497,58

Flat face screw couplings, connection u/pressure

Válvula plana autoroscante acoplamiento en presión

SV-Schraubkupplung flach

Coupleurs face plane à visser, connexion sous pression



ROSCA THREAD	TAMAÑO ISO ISO SIZE	TAMAÑO BG BG SIZE	Referencia Part n°	€	
3/8" BSP	M30x2	10	2	Z905106	257,25
1/2" BSP	M36x2	12,5	3	Z905108	316,68
3/4" BSP	M36x2	16	4A	Z905112	314,26
1" BSP	M43x3	19	4	Z905116	467,12
1 1/4" BSP	M48x3	25	5	Z905120	715,89
1 1/2" BSP	M80x4	40	7	Z905124	1.334,66
3/8" BSP	M30X2	10	2	Z905206	218,40
1/2" BSP	M36X2	12,5	3	Z905208	310,62
3/4" BSP	M36X2	16	4A	Z905212	286,36
1" BSP	M43X3	19	4	Z905216	424,69
1 1/4" BSP	M48X3	25	5	Z905220	612,72
1 1/2" BSP	M80X4	40	7	Z905224	2.014,13

Quick coupling ball type 700 bar connection u/pressure

Enchufes de bola 700 bar acoplamiento en presión

SVK, Kugeltyp, Hochdruck 700bar

Coupleurs rapides à bille 700 bar connexion sous pression



ROSCA THREAD	TAMAÑO ISO ISO SIZE	TAMAÑO BG BG SIZE	E. C.	Referencia Part n°	€
3/8" NPT	10	2	M	Z711106	95,25
3/8" NPT	10	2	H	Z711206	140,76

QUICK COUPLINGS AISI 316 TRΔLE®

Enchufes rápidos AISI 316 TrΔle®

SVK AISI 316 TrΔle®

Coupleurs rapides AISI 316 TrΔle®

Quick couplings 7241-A TrΔle

Enchufes TrΔle 7241-A

SVK 7241-A TrΔle

Coupleurs 7241-A TrΔle



ROSCA THREAD	TAMAÑO ISO ISO SIZE	TAMAÑO BG BG SIZE	E. C.	Referencia Part n°	€
1/4" BSP	6,3	1	M	ZB820104	16,59
3/8" BSP	10	2	M	ZB820106	25,44
1/2" BSP	12,5	3	M	ZB820108	42,85
3/4" BSP	20	4	M	ZB820112	77,89
1" BSP	25	5	M	ZB820116	108,19
1/4" BSP	6,3	1	H	ZB820204	40,30
3/8" BSP	10	2	H	ZB820206	60,89
1/2" BSP	12,5	3	H	ZB820208	101,77
3/4" BSP	20	4	H	ZB820212	182,32
1" BSP	25	5	H	ZB820216	254,37

Quick couplings 7241-A NPT TrΔle

Enchufes NPT TrΔle 7241-A

SVK 7241-A NPT TrΔle

Coupleurs 7241-A NPT TrΔle



ROSCA THREAD	TAMAÑO ISO ISO SIZE	TAMAÑO BG BG SIZE	E. C.	Referencia Part n°	€
1/4" NPT	6,3	1	M	ZB801104	16,32
3/8" NPT	10	2	M	ZB801106	25,92
1/2" NPT	12,5	3	M	ZB801108	43,66
3/4" NPT	20	4	M	ZB801112	79,36
1" NPT	25	5	M	ZB801116	110,23
1/4" NPT	6,3	1	H	ZB801204	39,65
3/8" NPT	10	2	H	ZB801206	62,04
1/2" NPT	12,5	3	H	ZB801208	103,69
3/4" NPT	20	4	H	ZB801212	185,76
1" NPT	25	5	H	ZB801216	259,17

Quick couplings 7241-B TrΔle

Enchufes TrΔle 7241-B

SVK I7241-B TrΔle

Coupleurs TrΔle 7241-B



ROSCA THREAD	TAMAÑO ISO ISO SIZE	TAMAÑO BG BG SIZE	E. C.	Referencia Part n°	€
1/8" BSP	5	0	M	NEW ZB800102	12,36
1/4" BSP	6,3	1	M	ZB800104	16,46
3/8" BSP	10	2	M	ZB800106	26,06
1/2" BSP	12,5	3	M	ZB800108	43,88
3/4" BSP	20	4	M	ZB800112	79,81
1" BSP	25	5	M	ZB800116	110,80
1/8" BSP	5	0	H	NEW ZB800202	27,65
1/4" BSP	6,3	1	H	ZB800204	39,88
3/8" BSP	10	2	H	ZB800206	62,37
1/2" BSP	12,5	3	H	ZB800208	104,22
3/4" BSP	20	4	H	ZB800212	186,77
1" BSP	25	5	H	ZB800216	260,55

Quick couplings 7241-B NPT TrΔle

Enchufes NPT TrΔle 7241-B

SVK 7241-B NPT TrΔle

Coupleurs 7241-B NPT TrΔle



ROSCA THREAD	TAMAÑO ISO ISO SIZE	TAMAÑO BG BG SIZE	E. C.	Referencia Part n°	€
1/4" NPT	6,3	1	M	ZB811104	15,73
3/8" NPT	10	2	M	ZB811106	24,86
1/2" NPT	12,5	3	M	ZB811108	41,84
3/4" NPT	20	4	M	ZB811112	75,89
1" NPT	25	5	M	ZB811116	105,35
1/4" NPT	6,3	1	H	ZB811204	37,94
3/8" NPT	10	2	H	ZB811206	59,31
1/2" NPT	12,5	3	H	ZB811208	99,10
3/4" NPT	20	4	H	ZB811212	177,49
1" NPT	25	5	H	ZB811216	247,64

Quick couplings free flow TrΔle 7241-B

Enchufes Paso Total TrΔle 7241-B

SVK TrΔle voller Durchgang 7241-B

Coupleurs passage total TrΔle 7241-B



ROSCA THREAD	TAMAÑO ISO ISO SIZE	TAMAÑO BG BG SIZE	E. C.	Referencia Part n°	€
1/4" BSP	6,3	1	M	ZB830104	25,09
3/8" BSP	10	2	M	ZB830106	31,73
1/2" BSP	12,5	3	M	ZB830108	38,49
3/4" BSP	20	4	M	ZB830112	61,68
1" BSP	25	5	M	ZB830116	99,32
1/4" BSP	6,3	1	H	ZB830204	68,43
3/8" BSP	10	2	H	ZB830206	80,87
1/2" BSP	12,5	3	H	ZB830208	96,42
3/4" BSP	20	4	H	ZB830212	134,87
1" BSP	25	5	H	ZB830216	284,90

Flat face quick coupling ISO16028 TrΔle

Enchufes de válvula plana ISO16028 TrΔle

SVK flach ISO16028 TrΔle

Coupleurs à clapet face plane ISO16028 TrΔle



ROSCA THREAD	TAMAÑO ISO ISO SIZE	TAMAÑO BG BG SIZE	E. C.	Referencia Part n°	€
1/4" BSP	6	1	M	ZB900104	65,90
3/8" BSP	10	2	M	ZB900106	87,57
1/2" BSP	12	3	M	ZB900108	120,82
3/4" BSP	16	4A	M	ZB900112	141,29
1" BSP	19	4	M	ZB900116	209,69
1/4" BSP	6	1	H	ZB900204	152,88
3/8" BSP	10	2	H	ZB900206	204,25
1/2" BSP	12	3	H	ZB900208	227,17
3/4" BSP	16	4A	H	ZB900212	250,13
1" BSP	19	4	H	ZB900216	459,33

BALL VALVES AISI 316

Llaves de paso AISI 316

Kugelhähne AISI 316

Robinets AISI 316

2 Way ball-valves BSP female ISO 228

Llave 2 vías rosca hembra BSP

2-Wege-KH w BSP ISO 228

Robinet haute pression 2 voies boisseau sphérique femelle BSP



DN	ROSCA THREAD	Referencia Part n°	€
4	1/8" BSP	MKH G 1/8	228,60
6	1/4" BSP	MKH G 1/4	151,78
10	3/8" BSP	MKH G 3/8	190,01
13	1/2" BSP	MKH G 1/2	195,60
16	5/8" BSP	MKH G 5/8	460,88
20	3/4" BSP	MKH G 3/4	467,46
25	1" BSP	MKH G 1	516,31
25	1" 1/4 BSP	MKH G 1 1/4 DN25	650,95
25	1" 1/2 BSP	MKH G 1 1/2 DN25	739,26

2 Way ball-valves: tube connection serie L DIN 2353

Llave 2 vías tubo rígido serie ligera

2-Wege-KH Rohr L Leichte Serie

Robinet haute pression 2 voies boisseau sphérique pour tube rigide série légère



DN	TUBO PIPE	ROSCA THREAD	Referencia Part n°	€
4	6 L	M12X1,5	MKH 6 L	303,94
6	8 L	M14X1,5	MKH 8 L	268,60
8	10 L	M16X1,5	MKH 10 L	268,60
10	12 L	M18X1,5	MKH 12 L	246,73
13	15 L	M22X1,5	MKH 15 L	287,71
16	18 L	M26X1,5	MKH 18 L	341,67
20	22 L	M30X2	MKH 22 L	501,13
25	28 L	M36X2	MKH 28 L	638,35
25/32	35 L	M45X2	MKH 35 L	669,57
25/40	42 L	M52X2	MKH 42 L	899,52

2 Way ball-valves: tube connection serie S DIN 2353

Llave 2 vías tubo rígido serie pesada

2-Wege-KH Rohr S Schwere Serie

Robinet haute pression 2 voies boisseau sphérique pour tube rigide série lourde



DN	TUBO PIPE	ROSCA THREAD	Referencia Part n°	€
4	8 S	M16X1,5	MKH 8 S	268,60
6	10 S	M18X1,5	MKH 10 S	280,34
8	12 S	M20X1,5	MKH 12 S	236,28
10	14 S	M22X1,5	MKH 14 S	310,70
13	16 S	M24X1,5	MKH 16 S	254,10
13	20 S	M30X2	MKH 20 S DN13	372,33
16	20 S	M30X2	MKH 20 S	431,08
25	30 S	M42X2	MKH 30 S	537,82
20	25 S	M36X2	MKH 25 S	466,35
25/32	38 S	M52X2	MKH 38 S	613,16

Ball-valves BSP female

Llave 2 vías rosca hembra BSP paso total

2-Wege-KH w BSP voller Durchgang

Robinet haute pression 2 voies boisseau sphérique femelle



DN	ROSCA THREAD	Referencia Part n°	€
32	1" 1/4 BSP	MKH G 1 1/4 DN32	1.109,37
50	2" BSP	MKH G 2 DN50	1.951,38

Ball-valves: tube connection serie L DIN 2353 full bore

Llave 2 vías tubo rígido L paso total

2-Wege-KH Rohr DIN 2353 L voller Durchgang

Robinet haute pression 2 voies boisseau sphérique Métrique série légère passage total



DN	TUBO PIPE	ROSCA THREAD	Referencia Part n°	€
35	35 L	M45X2	MKH 35 L DN35	1.286,23

Ball-valves: tube connection serie S DIN 2353 full bore

Llave 2 vías tubo rígido S paso total

2-Wege-KH Rohr DIN 2353 L voller Durchgang

Robinet haute pression 2 voies boisseau sphérique Métrique série légère passage total



DN	TUBO PIPE	ROSCA THREAD	Referencia Part n°	€
32	38 S	M52x2	MKH 38 S DN32	1.253,48

3 Way ball-valve female BSP L flow

Llave 3 vías hembra - hembra - hembra BSP paso en L

3-Wege-KH w - w BSP - BSP Typ L

Robinet haute pression 3 voies boisseau sphérique femelle BSP passage en L



DN	ROSCA THREAD	Referencia Part n°	€
4	1/8" BSP	MK3A-G 1/8	495,11
6	1/4" BSP	MK3A-G 1/4	389,72
10	3/8" BSP	MK3A-G 3/8	548,88
13	1/2" BSP	MK3A-G 1/2	480,30
20	3/4" BSP	MK3A-G 3/4	978,73
25	1" BSP	MK3A-G 1	1.374,84
25	1" 1/4 BSP	MK3A-G 1 1/4	1.431,07
40	1" 1/2 BSP	MK3A-G 1 1/2	1.528,35

BALL VALVES AISI 316

Llaves de paso AISI 316

Kugelhähne AISI 316

Robinets AISI 316

■ Handles for ball-valves 1

Manetas

Handhebel für Kugelhähne

Leviers pour robinets

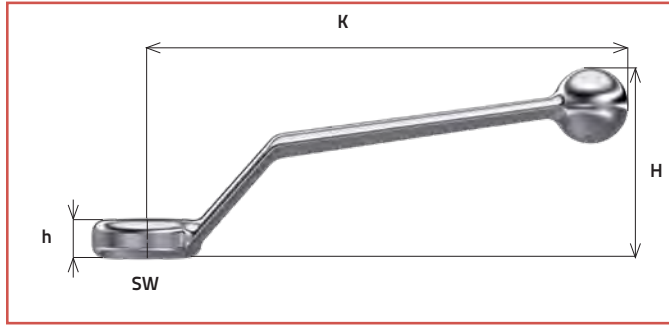

■ Handles for ball-valves 2

Manetas

Handhebel für Kugelhähne

Leviers pour robinets

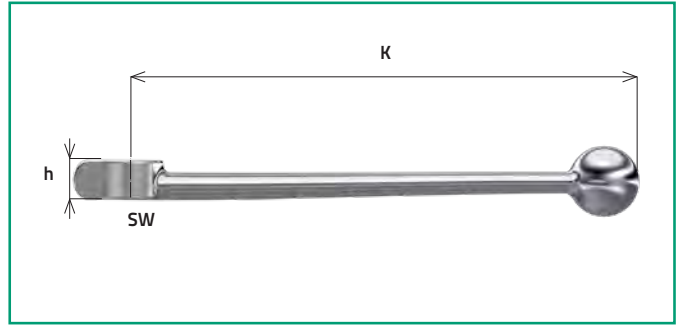

	SW	Zinc Zinc						Aluminio Aluminum			INOX/SS316L			Acero Steel		
Serie BSP 1/8 - 1/4 - 3/8 - 1/2 - 5/8	9	A60013155330* (1)			AR603722*						Z60013155330 *			C600063*		
Serie DIN 6 - 8 - 10 - 12 - 14 - 15 - 16		H	J	K	H	J	K	H	J	K	H	J	K	H	J	K
		45	8.7	155	-	10	155				45	8.7	155	47	9	155
Serie BSP 5/8	12							L501741* (1)								
Serie DIN 18		H	J	K	H	J	K	H	J	K	H	J	K	H	J	K
		55	12	160												
Serie BSP 3/4 - 1 - 1 1/4	14	A60013155331* (1)						LR606745 *			Z60013155331*			C708618*		
Serie DIN 22 - 25 - 28 - 30 - 35 - 38		H	J	K	H	J	K	H	J	K	H	J	K	H	J	K
		-	13	200	-	12	200	-	13	200	64	12	171			
Serie BSP 1 1/4 - 1 1/2 - 2	17							LR801799* (1)			Z60013155332*					
Serie DIN 3 3-5 - 38 - 42		H	J	K	H	J	K	H	J	K	H	J	K	H	J	K
		-	16	320	-	15	90									

■ Handles for ball-valves are supplied with zinc or aluminum

Las llaves se suministran con maneta de zinc o aluminio

Die Schlüssel werden mit Zink- oder Aluminiumgriff geliefert

Maniglia sono fornite con manico in zinco o alluminio

(1) Handles are supplied for ball-valves / Maneta sumistrada junto a la llave / Griff mit dem Schlüssel geliefert / Maniglia sono fornite con manico

BALL VALVES AISI 316

Llaves de paso AISI 316

Kugelhähne AISI 316

Robinets AISI 316

2 ways ball valve female BSP TrΔle

Llave 2 vías rosca hembra BSP TrΔle

2-Wege-KH w BSP TrΔle

Robinet haute pression 2 voies boisseau sphérique femelle BSP TrΔle



DN	ROSCA THREAD	Referencia Part n°	€
4	1/8" BSP	ZGB2V 1/8	74,73
6	1/4" BSP	ZGB2V 1/4	115,83
10	3/8" BSP	ZGB2V 3/8	141,31
13	1/2" BSP	ZGB2V 1/2	156,87
20	3/4" BSP	ZGB2V 3/4	240,08
25	1" BSP	ZGB2V 1	332,16

2 ways ball valve female NPT TrΔle

Llave 2 vías rosca hembra NPT TrΔle

2-Wege-KH w NPT TrΔle

Robinet haute pression 2 voies boisseau sphérique femelle NPT TrΔle



DN	ROSCA THREAD	Referencia Part n°	€
6	1/4" NPT	ZGB2V 1/4 NPT	115,83
10	3/8" NPT	ZGB2V 3/8 NPT	141,31
12	1/2" NPT	ZGB2V 1/2 NPT	156,87
19	3/4" NPT	ZGB2V 3/4 NPT	240,08
25	1" NPT	ZGB2V 1 NPT	379,72

2 ways ball valve: tube connector light serie TrΔle

Llave 2 vías tubo rígido serie ligera TrΔle

2-Wege-KH Rohr L Leichte Serie TrΔle

Robinet haute pression 2 voies boisseau sphérique sortie pour tube rigide Série légère TrΔle



DN	TUBO PIPE	ROSCA THREAD	Referencia Part n°	€
6	8 L	M14X1,5	ZGB2V 8 L	125,02
8	10 L	M16X1,5	ZGB2V 10 L	139,41
10	12 L	M18X1,5	ZGB2V 12 L	144,04
13	15 L	M22X1,5	ZGB2V 15 L	168,70
16	18 L	M26X1,5	ZGB2V 18 L	168,70
20	22 L	M30X2	ZGB2V 22 L	307,87
25	28 L	M36X2	ZGB2V 28 L	351,11

2 ways ball valve: tube connector heavy serie TrΔle

Llave 2 vías tubo rígido serie pesada TrΔle

2-Wege-KH Rohr S Schwere Serie TrΔle

Robinet haute pression 2 voies boisseau sphérique sortie pour tube rigide Série lourde TrΔle



DN	TUBO PIPE	ROSCA THREAD	Referencia Part n°	€
4	8 S	M16X1,5	ZGB2V 8 S	124,53
6	10 S	M18X1,5	ZGB2V 10 S	124,53
8	12 S	M20X1,5	ZGB2V 12 S	139,41
10	14 S	M22X1,5	ZGB2V 14 S	144,34
13	16 S	M24X1,5	ZGB2V 16 S	168,70
16	20 S	M30X2	ZGB2V 20 S	196,83
20	25 S	M36X2	ZGB2V 25 S	307,87

3 Way ball-valve female ISO 228

Llave 3 vías TrΔle hembra - hembra - hembra BSP paso en L

3-Wege-Kugelhähne weiblich - weiblich BSP - BSP Durchgang L

Robinet haute pression 3 voies boisseau sphérique femelle



DN	R1	Referencia Part n°	€
6	1/4" BSP	ZGB3VH 1/4	104,70
10	3/8" BSP	ZGB3VH 3/8	157,05
13	1/2" BSP	ZGB3VH 1/2	197,76
20	3/4" BSP	ZGB3VH 3/4	339,21
25	1" BSP	ZGB3VH 1	511,87

Handles for ball-valves

Manetas para llaves de paso

Handhebel für Kugelhähne

Leviers pour robinets



TAMAÑO SIZE	Referencia Part n°	€
HEX9	Z60013155330	22,12
HEX14	Z60013155331	37,12
HEX17	Z60013155332	254,04

See dimension table in page 247 / Ver tabla de dimensiones en pág 247 / Abmessungen entspr. der Tabelle auf S. 247 / Voir table de dimensions à la page 247

QUICK COUPLINGS, BALL VALVES AND SWIVEL FITTINGS AISI 316 TRΔle

Racores giratorios AISI 316 TrΔle
Edelstahl-Kupplungen, -Kugelhähne und -Drehverschraubungen AISI 316 TrΔle
Coupleurs rapides, robinets et raccords tournants AISI 316 TrΔle

Straight swivel fittings TrΔle

Racores giratorios rectos TrΔle

Gerade Drehverschraubungen TrΔle

Raccord tournant droit TrΔle



ROSCA THREAD	Referencia Part n°	€
1/4" BSP	Z GGL 1/4	219,80
3/8" BSP	Z GGL 3/8	252,27
1/2" BSP	Z GGL 1/2	283,04
3/4" BSP	Z GGL 3/4	361,62
1" BSP	Z GGL 1	484,06
1" 1/4 BSP	Z GGL 1 1/4	650,35
1" 1/2 BSP	Z GGL 1 1/2	931,16
2" BSP	Z GGL 2	1.248,48

Elbow 90° swivel female TrΔle

Racores giratorios 90° TrΔle

W-Drehverschraubungen 90° TrΔle

Raccord tournant coude 90° TrΔle



ROSCA THREAD	Referencia Part n°	€
1/4" BSP	Z GG90 1/4	277,35
3/8" BSP	Z GG90 3/8	333,20
1/2" BSP	Z GG90 1/2	373,50
3/4" BSP	Z GG90 3/4	501,14
1" BSP	Z GG90 1	616,44
1" 1/4 BSP	Z GG90 1 1/4	961,33
1" 1/2 BSP	Z GG90 1 1/2	1.329,63
2" BSP	Z GG90 2	1.909,13

RACORES GIRATORIOS | STRAIGHT SWIVEL FITTINGS



Racores giratorios para compensar la rotación y torsión de la manguera y prevenir sus posibles daños.

Straight swivel fittings can compensate the hose rotation and torsion to prevent possible damage.

Ver ficha técnica | Check technical sheet



CRIMPING FITTINGS
FOR HOSES

PIPE
FITTINGS

PIPE
FITTINGS II

ADAPTORS

WELDING
FITTINGS

INDUSTRIAL
FITTINGS

ACCESSORIES

CONTROL
COMPONENTS

FLOW
MEASURING

TRALE LOK

HYDRAULIC COMPONENTS AISI 316 | 253

Componentes hidráulicos AISI 316
Hydraulische Komponenten AISI 316
Composants Hydrauliques AISI 316

08

ELEMENTOS DE CONTROL

Elementos de control
Kontrollelemente
Éléments de contrôle



HYDRAULIC COMPONENTS AISI 316

Componentes hidráulicos AISI 316
Hydraulische Komponenten AISI 316
Composants Hydrauliques AISI 316

Flow control valves ▪ Reguladores caudal ▪ Flusskontrollventil ▪ Régulateurs de débit

| 253



ZFT2251B



ZFT2253U



ZFT22512B



ZFT22572B



ZFT22575U

Check-valves ▪ Anti-retornos ▪ Rückschlagventile - RV ▪ Clapet antiretour

| 254



Z FPR

Check-valves TrΔle® ▪ Anti-retornos TrΔle® ▪ Rückschlagventile -RV TrΔle® ▪ Clapet antiretour TrΔle®

| 254



ZVT0

Relief valves ▪ Limitadoras ▪ Überdruckventile ▪ Limiteurs de pression

| 254



ZLIM

HYDRAULIC COMPONENTS AISI 316

Componentes hidráulicos AISI 316
Hydraulische Komponenten AISI 316
Composants Hydrauliques AISI 316

Forged bidirectional flow control valve 350 Bar

Regulador caudal forjado bidireccional 350 Bar

Zweiwege-Ventile 350 Bar

Régulateur débit bidirectionnel forgé 350 Bar



ROSCA THREAD	CAUDAL MÁX. MAX. FLOW (l/min)	Referencia Part n°	€
1/4" BSP M17x1	12	ZFT2251B04	174,40
3/8" BSP M20x1	30	ZFT2251B06	215,37
1/2" BSP M25x1,5	45	ZFT2251B08	336,19
3/4" BSP M30x1,5	85	ZFT2251B12	452,81

Forged unidirectional flow control valve 350 Bar

Regulador caudal forjado unidireccional 350 Bar

Einweg-Steuerventile geschmiedet 350 Bar

Régulateur débit unidirectionnel forgé 350 Bar



ROSCA THREAD	CAUDAL MÁX. MAX. FLOW (l/min)	Referencia Part n°	€
1/4" BSP M17x1	12	ZFT2253U04	209,28
3/8" BSP M20x1	30	ZFT2253U06	254,77
1/2" BSP M25x1,5	45	ZFT2253U08	362,46
3/4" BSP M30x1,5	85	ZFT2253U12	486,64

Forged unidirectional flow control valve male/female 350 Bar

Regulador caudal forjado bidireccional macho/
hembra 350 Bar

Einweg-Steuerventil geschmiedet m- w 350 Bar

Régulateur débit bidirectionnel forgé mâle/femelle
350 Bar



ROSCA THREAD	CAUDAL MÁX. MAX. FLOW (l/min)	Referencia Part n°	€
1/8" BSP M15x1	10	ZFT22512B02	203,19
1/4" BSP M17x1	13	ZFT22512B04	189,00
3/8" BSP M20x1	30	ZFT22512B06	233,34
1/2" BSP M25x1,5	60	ZFT22512B08	345,86
3/4" BSP M30x1,5	80	ZFT22512B12	465,94

Bidirectional flow control valve 400 Bar

Regulador caudal bidireccional 400 Bar

Zweiweg-Steuerventil 400 Bar

Régulateur débit bidirectionnel 400 Bar



ROSCA THREAD	CAUDAL MÁX. MAX. FLOW (l/min)	Referencia Part n°	€
1/4" BSP M20x1	13	ZFT22572B04	256,35
3/8" BSP M25x1,5	38	ZFT22572B06	334,51
1/2" BSP M30x1,5	50	ZFT22572B08	487,90
3/4" BSP M40x1,5	80	ZFT22572B12	755,17
1" BSP M50x1,5	190	ZFT22572B16	1.520,01
1"1/4 BSP M50x1,5	195	ZFT22572B20	1.661,00
1" 1/2 BSP M55x2	200	ZFT22572B24	2.626,71
2" BSP M65x2	200	ZFT22572B32	3.428,11

Unidirectional flow control valve 400 Bar

Regulador caudal unidireccional 400 Bar

Einweg-Steuerventile 400 Bar

Régulateur débit unidirectionnel 400 Bar



ROSCA THREAD	CAUDAL MÁX. MAX. FLOW (l/min)	Referencia Part n°	€
1/8" BSP M17x1	6	ZFT22575U02	449,87
1/4" BSP M20x1	14	ZFT22575U04	378,32
3/8" BSP M25x1,5	20	ZFT22575U06	473,93
1/2" BSP M30x1,5	45	ZFT22575U08	641,08
3/4" BSP M40x1,5	80	ZFT22575U12	993,45
1" BSP M50x1,5	180	ZFT22575U16	1.709,22
1"1/4 BSP M50x1,5	200	ZFT22575U20	1.873,43
1" 1/2 BSP M55x2	200	ZFT22575U24	3.372,22
2" BSP M65x2	200	ZFT22575U32	4.469,25

HYDRAULIC COMPONENTS AISI 316

Componentes hidráulicos AISI 316
Hydraulische Komponenten AISI 316
Composants Hydrauliques AISI 316

Check-valve line mounting BSP

Anti-retorno en línea BSP

Rückschlagventil in Linie BSP

Clapet antiretour simple en ligne BSP

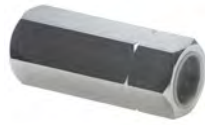

ROSCA THREAD	TARAJE (bar) SETTING (bar)	Referencia Part n°	€
1/4" BSP	0,5	Z FPR 1/4	57,90
1/4" BSP	2,5	Z FPR 1/4-2.5	104,98
1/4" BSP	5	Z FPR 1/4-5	104,98
1/4" BSP	10	Z FPR 1/4-10	104,98
3/8" BSP	0,5	Z FPR 3/8	66,48
3/8" BSP	2,5	Z FPR 3/8-2.5	113,04
3/8" BSP	5	Z FPR 3/8-5	113,04
3/8" BSP	10	Z FPR 3/8-10	145,34
1/2" BSP	0,5	Z FPR 1/2	75,48
1/2" BSP	2,5	Z FPR 1/2-2.5	134,58
1/2" BSP	5	Z FPR 1/2-5	134,58
1/2" BSP	10	Z FPR 1/2-10	134,58
3/4" BSP	0,5	Z FPR 3/4	133,69
1" BSP	0,5	Z FPR 1	206,26
1" 1/4 BSP	0,5	Z FPR 1 1/4	365,65
1" 1/2 BSP	0,5	Z FPR 1 1/2	441,60

For other standard spring pressures, consult us. / Para otras presiones de tarado estandar, consultar. / Bitte kontaktieren Sie uns für andere Standard-Drucke. / Pour d'autres pressions ressort standard, consultez-nous.

Check-valve line mounting BSP TrΔle®

Antiretorno en línea BSP TrΔle®

Rückschlagventil in Linie BSP TrΔle®

Clapet antiretour simple en ligne BSP TrΔle®



ROSCA THREAD	TARAJE (bar) SETTING (bar)	Referencia Part n°	€
1/4" BSP	0,5	ZVT001004	28,86
3/8" BSP	0,5	ZVT001006	35,87
1/2" BSP	0,5	ZVT001008	45,97
3/4" BSP	0,5	ZVT001012	69,92

For other standard spring pressures, consult us. / Para otras presiones de tarado estandar, consultar. / Bitte kontaktieren Sie uns für andere Standard-Drucke. / Pour d'autres pressions ressort standard, consultez-nous.

Relief valves in line BSP

Limitadoras en línea BSP

Überdruckventile in Leitung BSP

Limiteurs de pression en ligne BSP



ROSCA THREAD	CAMPO REG. (bar) REG RATE (bar)	CAUDAL MÁX. MAX. FLOW (l/min)	Referencia Part n°	€
1/2" BSP	25-100	40	ZLIM1225100	425,72
1/2" BSP	60-210	40	ZLIM1260210	425,72
1/2" BSP	100-300	40	ZLIM12100300	425,72

COMPONENTES HIDRÁULICOS Y NEUMÁTICOS
 www.dicsaes.com
 HYDRAULIC & PNEUMATIC COMPONENTS



CONSULTA EL
 CATÁLOGO DE
 COMPONENTES

REQUEST ON
 CATALOGUE
 COMPONENTS

TrAle®

- | | |
|---|---|
| DEPOSITOS, FILTROS, CAMPANAS Y ACOPLAMIENTOS | Δ TANKS, FILTERS, BELLHOUSINGS & COUPLINGS |
| BOMBAS, DIVISORES DE CAUDAL Y MULTIPLICADORES | Δ PUMPS, GEAR FLOW DIVIDERS & MULTIGEAR |
| VÁLVULAS HIDRÁULICAS Y DISTRIBUIDORES HIDRÁULICOS | Δ HYDRAULIC VALVES & HYDRAULIC CONTROL VALVES |
| ELECTROVÁLVULAS, PLACAS BASE, EMPUÑADURAS Y SELECTORAS | Δ DIRECTIONAL VALVES, SUBPLATES, JOYSTICKS & DIRECTIONAL VALVES |
| ACUMULADORES, PRESOSTATOS E INTERCAMBIADORES DE CALOR | Δ ACCUMULATORS, PRESSURE SWITCHES & HEAT EXCHANGERS |
| MINICENTRALES, MOTORES LENTOS HIDRÁULICOS y CILINDROS HIDRÁULICOS | Δ HYDRAULIC MOTORS, MINI POWER PACKS & HYDRAULIC CYLINDERS |

TEST COUPLINGS | 261

Racores de control
Kontrollarmaturen
Prises de pression

MICRO-HOSE FITTINGS | 262

Conexiones Micro-hose
Mikroschlauch-Armaturen
Embouts Capillaire

PRESSURE GAUGES AISI 316 WITH GLYCERIN | 263

Instrumentos de medición
Manometer AISI 316L mit Glyzerin
Manomètre AISI 316 avec glycérine



09

FLOW MEASURING

Metrología
Messtechnik
Test du circuit hydraulique

TEST COUPLINGS

Racores de control
Kontrollarmaturen
Prises de pression

Checking fittings ▪ Racores de Control ▪ Kontrollarmaturen ▪ Prises de pression



Z MPR...C/J



Z MPR TLM



Z MPR DL/S



Z MPR...NPT



Z MPR M...C/J

MICRO-HOSE FITTINGS

Conexiones Micro-hose
Mikroschlauch-Armaturen
Embouts Capillaire

Micro-hose fittings ▪ Conexiones Micro-hose ▪ Mikroschlauch-Armaturen ▪ Embouts Capillaire

| 262



Z55501



Z55505



Z55506



Z55504



Z55507



Z55503



Z55509



Z5550795

PRESSURE GAUGES AISI 316 WITH GLYCERIN

Instrumentos de medición
Manometer AISI 316L mit Glycerin
Manomètre AISI 316 avec glycérine

Pressure gauge DN 63 with glycerin ▪ Manómetros inox glicerina DN 63 ▪ Edelstahl-Manometer mit Glycerin
DN 63 ▪ Manomètre avec glycérine DN 63

263



ZMF163..V



ZMF163..DB

Pressure gauge DN 100 with glycerin ▪ Manómetros inox glicerina DN 100 ▪ Edelstahl-Manometer mit Glycerin
DN 100 ▪ Manomètre avec glycérine DN 100

263



ZMF1100..V



ZMF1100..DB

Valves for manometers ▪ Protectores manómetros ▪ Manometer-Schutzventil ▪ Valves pour manomètres

264



Z FPE



Z FPEA



ZFT2299

TEST COUPLINGS

Racores de control
Kontrollarmaturen
Prises de pression

Check couplings with captive seal and metallic cap

Racores de control BSP con junta y capuchón metálico

Kupplungen mit Flachdichtung prüfen und Metallkappe

Prises de pression avec joint plat et capuchon métallique



ROSCA THREAD	Referencia Part n°	\$
1/8" BSP	Z MPR 1/8 G	49,99
1/4" BSP	Z MPR 1/4 G	50,17
3/8" BSP	Z MPR 3/8 G	64,21
1/2" BSP	Z MPR 1/2 G	65,88

TLM Check couplings with metallic cap

Racores de control TLM con capuchón metálico

Kontrollarmaturen mit Ü-Mutter und Metallkappe

Prises de pression TLM avec capuchon métallique



TUBO PIPE	SERIE SERIES	ROSCA THREAD	Referencia Part n°	€
6	L	M12x1.5	Z MPR TLM 6L	119,04
8	L	M14x1.5	Z MPR TLM 8L	122,13
10	L	M16x1.5	Z MPR TLM 10L	107,02
12	L	M18x1.5	Z MPR TLM 12L	108,13
15	L	M22x1.5	Z MPR TLM 15L	113,19
6	S	M14x1.5	Z MPR TLM 6S	120,59
8	S	M16x1.5	Z MPR TLM 8S	108,13
10	S	M18x1.5	Z MPR TLM 10S	109,56
12	S	M20x1.5	Z MPR TLM 12S	109,80

Halfway check fitting for metal tube

Racor de control intermedio para tubo metálico

Kontroll-Zwischenverschraubung für Metallrohr

Raccord intermédiaire pour tube métallique



TUBO PIPE	SERIE SERIES	ROSCA THREAD	Referencia Part n°	€
6	L	M12X1,5	Z MPR DL 6	129,85
8	L	M14X1,5	Z MPR DL 8	136,04
10	L	M16X1,5	Z MPR DL 10	146,86
12	L	M18X1,5	Z MPR DL 12	132,96
15	L	M22X1,5	Z MPR DL 15	145,31
18	L	M26X1,5	Z MPR DL 18	166,96
22	L	M30X2	Z MPR DL 22	188,60
28	L	M36X2	Z MPR DL 28	285,99
35	L	M45X2	Z MPR DL 35	301,45
42	L	M52X2	Z MPR DL 42	275,18
6	S	M14X1,5	Z MPR DS 6	129,85
8	S	M16X1,5	Z MPR DS 8	142,24
10	S	M16X1,5	Z MPR DS 10	151,51
12	S	M18X1,5	Z MPR DS 12	140,69
14	S	M22X1,5	Z MPR DS 14	163,86
16	S	M24X1,5	Z MPR DS 16	151,51
20	S	M30X2	Z MPR DS 20	193,25
25	S	M36X2	Z MPR DS 25	239,61
30	S	M42X2	Z MPR DS 30	290,61
38	S	M52X2	Z MPR DS 38	290,61

NPT Check couplings with metallic cap

Racores de control NPT con capuchón metálico

NPT-Kupplungen prüfen mit Metallkappe

Prises de pression NPT avec capuchon métallique



ROSCA THREAD	Referencia Part n°	€
1/8" NPT	Z MPR 1/8 NPT	64,21
1/4" NPT	Z MPR 1/4 NPT	64,21
3/8" NPT	Z MPR 3/8 NPT	64,21

Metric Check couplings with captive seal and metallic cap NEW

Racores de control Métrico con Junta y capuchón metal

Metric Kupplungen mit Flachdichtung prüfen und Metallkappe

Prises de pression métrique avec joint plat et capuchon métallique



ROSCA THREAD	Referencia Part n°	€
M10X1.5	Z MPR M 10X1.5	62,49
M12X1.5	Z MPR M 12X1.5	62,49
M14X1.5	Z MPR M 14X1.5	60,88
M16X1.5	Z MPR M 16X1.5	60,88

MICRO-HOSE FITTINGS

Conexiones Micro-hose
Mikroschlauch-Armaturen
Embouts Capillaire

Ferrules AISI -303

Casquillos AISI-303

Pressfassungen AISI-303

Jupes AISI-303



DN	Referencia Part n°	€
2	Z555010100	2,88

Swivel female flat seat with o'ring for manometer Micro-hose

Hembra asiento plano con junta manómetro

Dichtkopf flachdichtend mit Dichtring für Manometer

Embout femelle tournante fond plat avec o'ring pour manomètre Minimes



DN	ROSCA THREAD	Referencia Part n°	€
2	1/4" BSP	Z555050404	17,42
2	1/2" BSP	Z555050808	29,50

Check Metric swivel female Micro-hose

Hembra giratoria de control

Kontroll-Dichtkopf mit Ü-Mutter

Embout femelle tournante de control Métrique Minimes



DN	ROSCA THREAD	Referencia Part n°	€
2	M16X2	Z555069523	18,57

Straight swivel female BSP 60° cone micro-hose

Hembra giratoria BSP 60°

Dichtkopf 60°

Embout femelle tournante gaz cyl BSP 60° Minimes



DN	ROSCA THREAD	Referencia Part n°	€
2	1/8" BSP	Z555040202	32,66
2	1/4" BSP	Z555040404	17,81
2	3/8" BSP	Z555040606	28,84

Metric standpipe Micro-hose

Espiga lisa Métrica

Metr. Stutzen glatt

Embout lisse Métrique Minimes



DN	TUBO PIPE	Referencia Part n°	€
2	6	Z555070600	8,36
2	8	Z555070800	11,64

Straight Micro-hose check male

Macho de control

Kontroll-Außengewinde

Embout mâle manomètre



DN	Referencia Part n°	€
2	Z555030325	9,93

Straight swivel female JIC 37° Micro-hose

NEW

Hembra giratoria recta JIC 37°

Dichtkopf mit Ü-Mutter gerade JIC 37°

Embout femelle tournante JIC 37° Minimes



DN	ROSCA THREAD	Referencia Part n°	€
2	7/16" 20h UNF	Z555090700	24,17

Check 24° Metric swivel female with o'ring

NEW

Hembra giratoria Métrica con Junta

Kontroll-Dichtkopf 24° metrisch mit O-Ring

Embout femelle tournante de control Métrique 24° avec o'ring



DN	TUBO PIPE	ROSCA THREAD	Referencia Part n°	€
2	6L	M12X1,5	Z555079510	12,60
2	6S	M14X1,5	Z555079511	26,77
2	8L	M14X1,5	Z555079512	28,41
2	8S	M16X1,5	Z555079523	29,85
2	10L	M16X1,5	Z555079525	32,66

PRESSURE GAUGES AISI 316 WITH GLYCERIN

Instrumentos de medición
Manometer AISI 316L mit Glycerin
Manomètre AISI 316 avec glycérine

Pressure gauge DN 63 vertical connection

Manómetros DN 63 salida vertical

Manometer DN 63 Ausgang vertikal

Manomètre DN 63 sortie verticale



ROSCA THREAD	ESCALA (bar) SCALE (bar)	Referencia Part n°	€
1/4" BSP	0-2.5	ZMFI6304002.5V	*
1/4" BSP	0-4	ZMFI6304004V	*
1/4" BSP	0-6	ZMFI6304006V	30,41
1/4" BSP	0-10	ZMFI6304010V	30,41
1/4" BSP	0-16	ZMFI6304016V	30,41
1/4" BSP	0-25	ZMFI6304025V	30,41
1/4" BSP	0-40	ZMFI6304040V	30,41
1/4" BSP	0-60	ZMFI6304060V	30,41
1/4" BSP	0-100	ZMFI6304100V	30,41
1/4" BSP	0-160	ZMFI6304160V	30,41
1/4" BSP	0-250	ZMFI6304250V	30,41
1/4" BSP	0-400	ZMFI6304400V	30,41
1/4" BSP	0-600	ZMFI6304600V	30,41

Pressure gauge DN 63 rear connection

Manómetros DN 63 dorsal

Manometer DN 63 Ausgang hinten

Manomètre DN 63 sortie arrière



ROSCA THREAD	ESCALA (bar) SCALE (bar)	Referencia Part n°	€
1/4" BSP	0-2.5	ZMFI63042.5DB	*
1/4" BSP	0-10	ZMFI6304010DB	33,80
1/4" BSP	0-16	ZMFI6304016DB	33,80
1/4" BSP	0-25	ZMFI6304025DB	33,80
1/4" BSP	0-60	ZMFI6304060DB	33,80
1/4" BSP	0-160	ZMFI6304160DB	33,80
1/4" BSP	0-250	ZMFI6304250DB	33,80
1/4" BSP	0-400	ZMFI6304400DB	33,80

Pressure gauge DN 100 vertical connection

Manómetros DN 100 salida vertical

Manometer DN 100 Ausgang vertikal

Manomètre DN 100 sortie verticale



ROSCA THREAD	ESCALA (bar) SCALE (bar)	Referencia Part n°	€
1/2" BSP	0-6	ZMFI10008006V	51,72
1/2" BSP	0-10	ZMFI10008010V	51,72
1/2" BSP	0-16	ZMFI10008016V	51,72
1/2" BSP	0-25	ZMFI10008025V	51,72
1/2" BSP	0-40	ZMFI10008040V	51,72
1/2" BSP	0-60	ZMFI10008060V	51,72
1/2" BSP	0-100	ZMFI10008100V	51,72
1/2" BSP	0-160	ZMFI10008160V	51,72
1/2" BSP	0-250	ZMFI10008250V	51,72
1/2" BSP	0-400	ZMFI10008400V	51,72
1/2" BSP	0-600	ZMFI10008600V	51,72

Pressure gauge DN 100 rear connection

Manómetros DN 100 dorsal

Manometer DN 100 Ausgang hinten

Manomètre DN 100 sortie arrière



ROSCA THREAD	ESCALA (bar) SCALE (bar)	Referencia Part n°	€
1/2" BSP	0-1	ZMFI10008001DB	55,67
1/2" BSP	0-4	ZMFI10008004DB	55,67
1/2" BSP	0-6	ZMFI10008006DB	55,67
1/2" BSP	0-10	ZMFI10008010DB	55,67
1/2" BSP	0-16	ZMFI10008016DB	55,67
1/2" BSP	0-25	ZMFI10008025DB	55,67
1/2" BSP	0-40	ZMFI10008040DB	55,67
1/2" BSP	0-60	ZMFI10008060DB	55,67
1/2" BSP	0-100	ZMFI10008100DB	55,67
1/2" BSP	0-160	ZMFI10008160DB	55,67
1/2" BSP	0-250	ZMFI10008250DB	55,67
1/2" BSP	0-400	ZMFI10008400DB	*

PRESSURE GAUGES AISI 316 WITH GLYCERIN

Instrumentos de medición
Manometer AISI 316L mit Glyzerin
Manomètre AISI 316 avec glycérine

Pressure gauge protector (line mounting)

Protector manómetro recto

Manometer-Schutzventil in Linie

Isolateur de manomètre droit (en ligne)



ROSCA THREAD		Referencia Part n°	€
1/4" BSP	1/4" BSPT	Z FPE 1G 1/4	201,15

90° pressure gauge protector (line mounting)

Protector manómetro 90°

Manometer-Schutzventil 90°

Isolateur de manomètre coudé a 90° (en ligne)



ROSCA THREAD		Referencia Part n°	€
1/4" BSP	1/4" BSPT	Z FPEA 1G 1/4	201,15

Pressure gauge adaptor (in line) SF-FM

Adaptador para manómetro en línea TL-MF

Manometer- Adapter TL- MF

Adapteur pour manomètre (en ligne) TL-MF



ROSCA (I/M) THREAD (M)	ROSCA (H) THREAD / F)	Referencia Part n°	€
1/4" BSPT	1/4" BSP	ZFT229904	70,70
1/2" BSPT	1/2" BSP	ZFT229908	94,38

La calidad garantiza el *mejor* rendimiento.

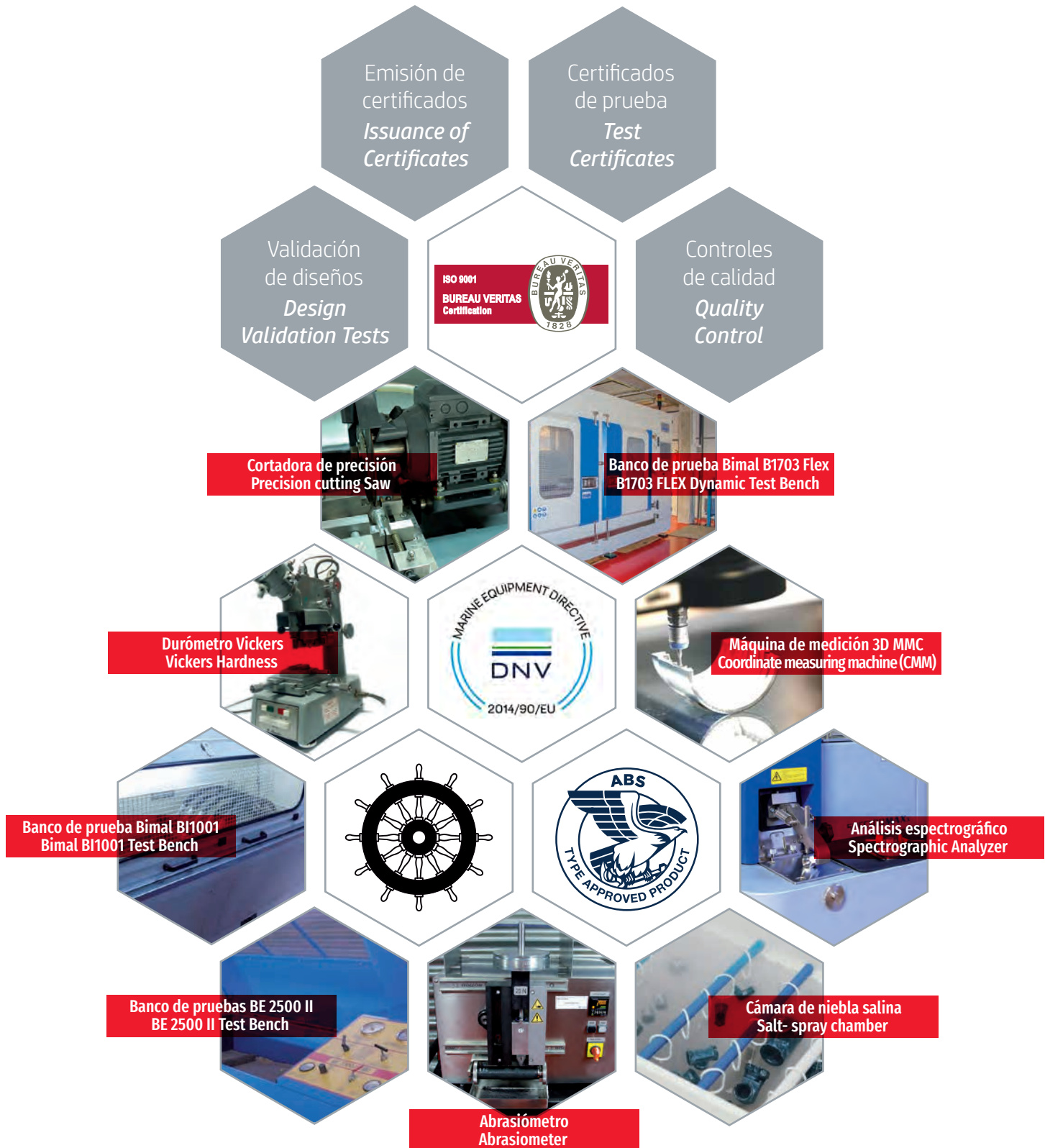

Quality guarantees the *best* performance.

TWIN FERRULE FITTINGS TRALE® LOK | 271

Racor Doble Anillo TRALE LOK
Verschraubungen für Doppelklemmring TRALE LOK
Raccords double bague TRALE LOK

10

TWIN FERRULE FITTINGS TRALE® LOK

TRALE® Lok

Verschraubungen für Doppelklemmring TRALE LOK
Raccords double bague TRALE LOK



TWIN FERRULE FITTINGS TRALE® LOK

Racor Doble Anillo TRALE LOK
Verschraubungen für Doppelklemmring TRALE LOK
Raccords double bague TRALE LOK

Nuts and rings ▪ Tuercas y anillos ▪ Muttern und Schneidringe ▪ Écrous et bagues

| 271



ZKN



ZKAP



ZKAF

Straight couplings ▪ Uniones tubo-tubo ▪ Gerade Verschraubungen (G) ▪ Raccords union double

| 272



ZKI



ZKL



ZKI



ZKT



ZKC

Straight male stud couplings ▪ Uniones rectas tubo-rosca macho ▪ Gerade Einschraubverschr. - EVGE ▪ Raccords union simple mâle

| 274



ZKIMP



ZKIM

Male stud elbows ▪ Codos tubo-rosca ▪ W-Einschraubverschraubungen - WE ▪ Raccords coude mâle gaz

| 275



ZKLMP



ZKLM

Male stud branch ▪ TES rosca central ▪ T-Einschraubungen - TE ▪ Raccords Té mâle central

| 275



ZKTMP

Male stud barrel ▪ TES rosca lateral ▪ T-einschraubungen ▪ Raccords Té mâle latéral

| 276



ZKTLMP

Bulkhead ▪ Pasatabiques ▪ Schott ▪ Raccords passe cloison

| 276



ZKIB



ZKIBP

Straight female coupling ▪ Racor recto hembra ▪ Gerade Kupplung ▪ Raccords droits femelle

| 277



ZKIHP

Plugs ▪ Tapones ▪ Stopfen ▪ Raccords bouchon métrique

| 278



ZKOH



ZKOM

TWIN FERRULE FITTINGS TRΔLE® LOK

Racor Doble Anillo TRΔLE LOK
Verschraubungen für Doppelklemmring TRΔLE LOK
Raccords double bague TRΔLE LOK

Pipe connector ▪ Conectores para tubo ▪ Rohrverbinder ▪ Connecteur de tuyau

| 278



ZKIA

ZKIAMP

ZKIAHP

TRALE® LOK SERIES

INFORMACIÓN DE CODIFICACIÓN / CODIFICATION INFORMATION

1 EJEMPLO- EXAMPLE

ZKTK

ZK: DICSA TRALE® LOK SERIES

T: FIGURA (RACOR EN TE)/
FIGURE (TE UNION)

02: Ø Tubo (02 = 1/8")
Ø Tube (02 = 1/8")

2 EJEMPLO- EXAMPLE

ZKIMP0202

ZK: DICSA TRALE® LOK SERIES

IM: RACOR RECTO ROSCA TUBO/
STRAIGHT MALE STUD

P02: MACHO 1/8" NPT
MALE 1/8" NPT

02: Ø Tubo (02 = 1/8")
Ø Tube (02 = 1/8")

REF / CODE	DESCRIPCION / DESCRIPTION
ZKN	Tuercas / Nuts
ZKAP	Anillo trasero / Back Ferrule
ZKAF	Anillo frontal / Front Ferrule
ZKI	Unión recta / Straight Union
ZKL	Unión en codo / Elbow Union
ZKT	Unión en T / Tee Union
ZKC	Unión en cruz / Cross Union
ZKIM	Unión recta tubo-rosca / Straight male stud
ZKLMP	Codo tubo - rosca / Male stud elbow
ZKTMP	T tubo - rosca / Male stud T
ZKTLM	L tubo - rosca / Male stud L
ZKIB	Pasatabiques recto / Straight bulkhead
ZKIBP	Pasatabiques tubo-rosca / Male stud bulkhead
ZKIHP	Unión tubo-rosca hembra / Straight female stud
ZKOH	Tapón hembra / Cap
ZKOM	Tapón macho / Plug
ZKIA	Reductor tubo / Pipe Reducer
ZKIAH	Adap. hembra / Female adapter
ZKIMP	Adap. macho / Male adapter

DESIGNACIÓN DE TUBO EXTERIOR/ TUBE O.D. DESIGNATOR

TUBO EN PULGADAS / FRACTIONAL TUBE								TUBO MÉTRICO / METRIC TUBE										
1/8"	1/4"	5/16"	3/8"	1/2"	5/8"	3/4"	1"	6	8	10	12	14	15	16	18	20	22	25
02	04	05	06	08	10	12	16	06M	08M	10M	12M	14M	15M	16M	18M	20M	22M	25M



TWIN FERRULE FITTINGS TRΔLE® LOK

Racor Doble Anillo TRΔLE LOK
 Verschraubungen für Doppelklemmring TRΔLE LOK
 Raccords double bague TRΔLE LOK

Nut for twin-ferrule

Tuercas para doble anillo

Mutter für Doppelklemmring

Écrou double bagues



TUBO PIPE	Referencia Part n°	€
1/8"	ZKN02	5,20
1/4"	ZKN04	5,40
5/16"	ZKN05	*
3/8"	ZKN06	6,45
1/2"	ZKN08	8,50
5/8"	ZKN10	*
3/4"	ZKN12	19,55
1"	ZKN16	38,13
6	ZKN06M	5,40
8	ZKN08M	5,95
10	ZKN10M	6,80
12	ZKN12M	8,40
14	ZKN14M	*
15	ZKN15M	18,07
16	ZKN16M	*
18	ZKN18M	27,76
20	ZKN20M	*
22	ZKN22M	*
25	ZKN25M	*

Back Ferrule

Anillo posterior

Hinterer Klemmring

Bague arrière



TUBO PIPE	Referencia Part n°	€
1/8"	ZKAP02	2,15
1/4"	ZKAP04	2,25
5/16"	ZKAP05	*
3/8"	ZKAP06	2,60
1/2"	ZKAP08	4,20
5/8"	ZKAP10	*
3/4"	ZKAP12	9,15
1"	ZKAP16	17,16
6	ZKAP06M	2,25
8	ZKAP08M	2,45
10	ZKAP10M	2,65
12	ZKAP12M	4,10
14	ZKAP14M	*
15	ZKAP15M	8,00
16	ZKAP16M	*
18	ZKAP18M	11,86
20	ZKAP20M	*
22	ZKAP22M	*
25	ZKAP25M	*

Front Ferrule

Anillo frontal

Vorderer Klemmring

Bague avant



TUBO PIPE	Referencia Part n°	€
1/8"	ZKAF02	1,95
1/4"	ZKAF04	1,95
5/16"	ZKAF05	*
3/8"	ZKAF06	2,10
1/2"	ZKAF08	3,35
5/8"	ZKAF10	*
3/4"	ZKAF12	6,55
1"	ZKAF16	10,83
6	ZKAF06M	1,95
8	ZKAF08M	2,10
10	ZKAF10M	2,20
12	ZKAF12M	3,30
14	ZKAF14M	*
15	ZKAF15M	6,55
16	ZKAF16M	*
18	ZKAF18M	10,15
20	ZKAF20M	*
22	ZKAF22M	*
25	ZKAF25M	*

TWIN FERRULE FITTINGS TRALE® LOK

Racor Doble Anillo TRALE LOK
Verschraubungen für Doppelklemmring TRALE LOK
Raccords double bague TRALE LOK

Double Straight coupling

Racor unión recta tubo - tubo

Gerade Verschraubungen (G)

Raccord union double



TUBO PIPE	Referencia Part n°	€
1/8"	ZKI02	24,10
1/4"	ZKI04	24,95
5/16"	ZKI05	*
3/8"	ZKI06	28,35
1/2"	ZKI08	39,85
5/8"	ZKI10	*
3/4"	ZKI12	78,09
1"	ZKI16	*
6	ZKI06M	25,15
8	ZKI08M	27,00
10	ZKI10M	29,95
12	ZKI12M	39,55
14	ZKI14M	*
15	ZKI15M	67,26
16	ZKI16M	*
18	ZKI18M	67,85
20	ZKI20M	98,10
22	ZKI22M	*
25	ZKI25M	*

Equal elbow coupling

Racor unión en codo tubo - tubo

Winkel-Verschraubungen (W)

Raccord coude égal



TUBO PIPE	Referencia Part n°	€
1/8"	ZKL02	29,55
1/4"	ZKL04	30,15
5/16"	ZKL05	*
3/8"	ZKL06	35,10
1/2"	ZKL08	46,85
5/8"	ZKL10	*
3/4"	ZKL12	82,90
1"	ZKL16	150,70
6	ZKL06M	30,10
8	ZKL08M	33,70
10	ZKL10M	37,80
12	ZKL12M	46,25
14	ZKL14M	*
15	ZKL15M	*
16	ZKL16M	85,45
18	ZKL18M	89,70
20	ZKL20M	140,20
22	ZKL22M	*
25	ZKL25M	150,35

Straight reducing coupling

Racor unión recta en reducción tubo - tubo

Gerade Reduzierschraubungen (GR)

Raccord union double en réduction



TUBO PIPE		Referencia Part n°	€
1/4"	1/8"	ZKI0402	24,65
5/16"	1/4"	ZKI0504	*
3/8"	1/8"	ZKI0602	25,85
3/8"	1/4"	ZKI0604	26,25
1/2"	1/4"	ZKI0804	*
1/2"	3/8"	ZKI0806	34,65
5/8"	3/8"	ZKI1006	*
5/8"	1/2"	ZKI1008	*
3/4"	1/4"	ZKI1204	*
3/4"	3/8"	ZKI1206	*
3/4"	1/2"	ZKI1208	*
1"	1/2"	ZKI1608	*
1"	3/4"	ZKI1612	*
6	3	ZKI06M03M	*
8	6	ZKI08M06M	26,25
10	6	ZKI10M06M	26,80
10	8	ZKI10M08M	27,65
12	6	ZKI12M06M	33,25
12	8	ZKI12M08M	34,65
12	10	ZKI12M10M	35,55
16	12	ZKI16M12M	*
18	18	ZKI18M12M	49,75
25	18	ZKI25M18M	105,15
25	20	ZKI25M20M	112,15

Equal Tee

Racor unión en T tubo - tubo

T-Verschraubungen (T)

Raccord Té égal



TUBO PIPE	Referencia Part n°	€
1/8"	ZKT02	42,30
1/4"	ZKT04	43,25
5/16"	ZKT05	*
3/8"	ZKT06	50,95
1/2"	ZKT08	67,00
5/8"	ZKT10	*
3/4"	ZKT12	*
1"	ZKT16	218,25
6	ZKT06M	43,20
8	ZKT08M	49,50
10	ZKT10M	51,75
12	ZKT12M	66,30
14	ZKT14M	*
15	ZKT15M	*
16	ZKT16M	*
18	ZKT18M	127,10
20	ZKT20M	202,15
22	ZKT22M	*
25	ZKT25M	217,75

TWIN FERRULE FITTINGS TRΔLE® LOK

Racor Doble Anillo TRΔLE LOK
Verschraubungen für Doppelklemmring TRΔLE LOK
Raccords double bague TRΔLE LOK

Equal cross

Racor unión en cruz tubo - tubo

Kreuz-Verschraubungen (K)

Raccord croix égale



TUBO PIPE	Referencia Part n°	€
1/8"	ZKC02	*
1/4"	ZKC04	*
5/16"	ZKC05	*
3/8"	ZKC06	*
1/2"	ZKC08	*
6	ZKC06M	*
8	ZKC08M	*
10	ZKC10M	*
12	ZKC12M	*

■ TrΔle® Lok SERIES

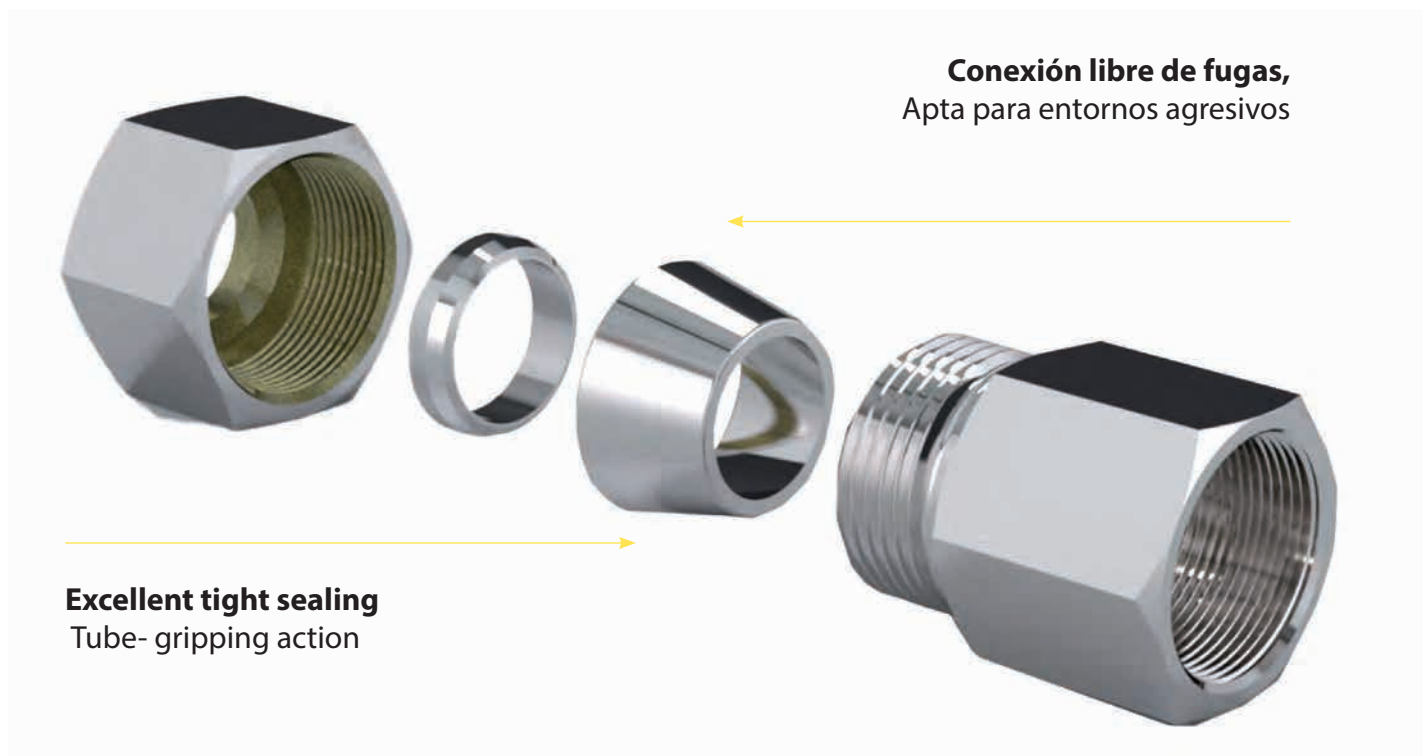

TWIN FERRULE FITTINGS TRALE® LOK

Racor Doble Anillo TRALE LOK
Verschraubungen für Doppelklemmring TRALE LOK
Raccords double bague TRALE LOK

Straight male stud coupling NPT

Racor recto rosca cónica NPT

Gerade Einschraubverschr. NPT - GE -NPT

Raccord union simple mâle NPT

**Straight male stud coupling BSPT**

Racor recto rosca cónica BSPT

Gerade Einschraubverschr. kegelig - GE-BSPT

Raccord union simple mâle conique



TUBO PIPE	ROSCA THREAD		Referencia Part n°	€
1/16"	1/8"	NEW	ZKIMP0102	*
1/8"	1/16"	NEW	ZKIMP0201	*
1/8"	1/8"		ZKIMP0202	14,25
1/8"	1/4"		ZKIMP0204	14,75
1/8"	3/8"		ZKIMP0206	15,85
1/8"	1/2"		ZKIMP0208	19,15
1/4"	1/8"		ZKIMP0402	14,60
1/4"	1/4"		ZKIMP0404	15,10
1/4"	3/8"		ZKIMP0406	16,15
1/4"	1/2"		ZKIMP0408	19,50
3/8"	1/8"		ZKIMP0602	16,65
3/8"	1/4"		ZKIMP0604	16,95
3/8"	3/8"		ZKIMP0606	17,45
3/8"	1/2"		ZKIMP0608	20,15
3/8"	3/4"	NEW	ZKIMP0612	25,80
3/8"	1"	NEW	ZKIMP0616	45,70
1/2"	1/8"		ZKIMP0802	24,70
1/2"	1/4"		ZKIMP0804	24,70
1/2"	3/8"		ZKIMP0806	24,70
1/2"	1/2"		ZKIMP0808	26,00
1/2"	3/4"	NEW	ZKIMP0812	35,10
3/4"	3/8"	NEW	ZKIMP1206	46,00
3/4"	1/2"	NEW	ZKIMP1208	47,15
3/4"	3/4"	NEW	ZKIMP1212	53,95
3/4"	1/4"	NEW	ZKIMP1216	59,25
1"	1/2"	NEW	ZKIMP1608	77,85
1"	3/4"	NEW	ZKIMP1612	79,95
1"	1"	NEW	ZKIMP1616	82,45
3	1/8"	NEW	ZKIMP03M02	*
6	1/8"		ZKIMP06M02	14,80
6	1/4"		ZKIMP06M04	15,05
6	3/8"		ZKIMP06M06	16,30
6	1/2"		ZKIMP06M08	19,35
8	1/8"		ZKIMP08M02	15,85
8	1/4"		ZKIMP08M04	16,10
8	3/8"		ZKIMP08M06	17,00
8	1/2"		ZKIMP08M08	20,85
10	1/8"		ZKIMP10M02	18,60
10	1/4"		ZKIMP10M04	19,00
10	3/8"		ZKIMP10M06	19,00
10	1/2"		ZKIMP10M08	21,80
10	3/4"	NEW	ZKIMP10M12	34,85
12	1/4"		ZKIMP12M04	24,75
12	3/8"		ZKIMP12M06	24,75
12	1/2"		ZKIMP12M08	25,35
14	3/8"	NEW	ZKIMP14M06	*
14	1/2"	NEW	ZKIMP14M08	*
15	1/2"	NEW	ZKIMP15M08	*
16	1/4"	NEW	ZKIMP16M04	*
16	3/8"	NEW	ZKIMP16M06	*
16	1/2"	NEW	ZKIMP16M08	*
16	3/4"	NEW	ZKIMP16M12	*
18	1/2"	NEW	ZKIMP18M08	*
18	3/4"	NEW	ZKIMP18M12	*
22	3/4"	NEW	ZKIMP22M12	*
22	1"	NEW	ZKIMP22M16	*
25	1/2"	NEW	ZKIMP25M08	77,30
25	3/4"	NEW	ZKIMP25M12	79,80
25	1"	NEW	ZKIMP25M16	82,30

TUBO PIPE	ROSCA THREAD		Referencia Part n°	€
1/8	1/8"	NEW	ZKIM0202	14,25
1/8	1/4"	NEW	ZKIM0204	14,75
1/4"	1/8"	NEW	ZKIM0402	14,60
1/4"	1/4"		ZKIM0404	15,10
1/4"	3/8"	NEW	ZKIM0406	16,15
1/4"	1/2"	NEW	ZKIM0408	19,50
3/8"	1/8"	NEW	ZKIM0602	16,65
3/8"	1/4"		ZKIM0604	16,95
3/8"	3/8"		ZKIM0606	17,45
3/8"	1/2"	NEW	ZKIM0608	20,15
3/8"	3/4"	NEW	ZKIM0612	30,10
1/2"	1/4"		ZKIM0804	24,70
1/2"	3/8"		ZKIM0806	24,70
1/2"	1/2"		ZKIM0808	26,00
1/2"	3/4"	NEW	ZKIM0812	35,10
3/4"	3/4"	NEW	ZKIM1212	53,95
3/4"	1"	NEW	ZKIM1216	59,25
1"	3/4"	NEW	ZKIM1612	79,95
6	1/8"	NEW	ZKIM06M02	14,80
6	1/4"		ZKIM06M04	15,05
6	3/8"		ZKIM06M06	16,30
6	1/2"		ZKIM06M08	19,35
8	1/8"	NEW	ZKIM08M02	15,85
8	1/4"	NEW	ZKIM08M04	16,10
8	3/8"		ZKIM08M06	17,00
8	1/2"		ZKIM08M08	20,85
10	1/8"	NEW	ZKIM10M02	18,60
10	1/4"	NEW	ZKIM10M04	*
10	3/8"		ZKIM10M06	19,00
10	1/2"		ZKIM10M08	21,80
12	3/8"	NEW	ZKIM12M06	24,75
12	1/2"		ZKIM12M08	31,19
16	1/4"	NEW	ZKIM16M04	*
16	3/8"	NEW	ZKIM16M06	*
16	1/2"	NEW	ZKIM16M08	*
16	3/4"	NEW	ZKIM16M12	*
18	1/2"	NEW	ZKIM18M08	48,65
18	3/4"	NEW	ZKIM18M12	52,15
22	3/4"	NEW	ZKIM22M12	*
22	1"	NEW	ZKIM22M16	*
25	3/4"	NEW	ZKIM25M12	79,80
25	1"	NEW	ZKIM25M16	82,30
25	1/2"	NEW	ZKIM25M08	77,30

TWIN FERRULE FITTINGS TRALE® LOK

Racor Doble Anillo TRALE LOK
Verschraubungen für Doppelklemmring TRALE LOK
Raccords double bague TRALE LOK

Male stud elbow NPT

Racor en codo rosca cónica NPT

W-Einschraubverschr. NPT - WE-NPT kon

Raccord union coude mâle NPT



TUBO PIPE	ROSCA THREAD	Referencia Part n°	€
1/8"	1/8"	ZKLMP0202	21,45
1/8"	1/4"	ZKLMP0204	22,00
1/8"	3/8"	ZKLMP0206	24,25
1/4"	1/8"	ZKLMP0402	21,80
1/4"	1/4"	ZKLMP0404	22,30
1/4"	3/8"	ZKLMP0406	24,25
1/4"	1/2"	ZKLMP0408	30,15
3/8"	1/8"	ZKLMP0602	25,55
3/8"	1/4"	ZKLMP0604	25,55
3/8"	3/8"	ZKLMP0606	25,55
3/8"	1/2"	ZKLMP0608	32,00
3/8"	3/4"	NEW ZKLMP0612	47,05
1/2"	1/4"	ZKLMP0804	33,55
1/2"	3/8"	ZKLMP0806	33,55
1/2"	1/2"	ZKLMP0808	35,70
3/4"	1/2"	NEW ZKLMP1208	63,05
3/4"	3/4"	NEW ZKLMP1212	63,05
1"	3/4"	NEW ZKLMP1612	107,35
1"	1"	NEW ZKLMP1616	107,35
16	1/4"	NEW ZKLMP16M04	*
16	3/8"	NEW ZKLMP16M06	*
6	1/8"	ZKLMP06M02	21,80
6	1/4"	ZKLMP06M04	22,25
16	1/2"	NEW ZKLMP16M08	*
16	3/4"	NEW ZKLMP16M12	*
6	3/8"	ZKLMP06M06	24,25
6	1/2"	ZKLMP06M08	30,75
8	1/8"	ZKLMP08M02	24,10
8	1/4"	ZKLMP08M04	24,10
8	3/8"	ZKLMP08M06	24,55
8	1/2"	ZKLMP08M08	31,55
10	1/8"	ZKLMP10M02	27,75
10	1/4"	ZKLMP10M04	27,75
10	3/8"	ZKLMP10M06	27,75
10	1/2"	ZKLMP10M08	31,85
12	1/4"	ZKLMP12M04	33,30
12	3/8"	ZKLMP12M06	33,30
12	1/2"	ZKLMP12M08	35,45
12	3/4"	NEW ZKLMP12M12	50,50
18	1/2"	NEW ZKLMP18M08	59,75
18	3/4"	NEW ZKLMP18M12	*
22	3/4"	NEW ZKLMP22M12	*
22	1"	NEW ZKLMP22M16	*
25	3/4"	NEW ZKLMP25M12	107,20
25	1"	NEW ZKLMP25M16	107,20

Male stud elbow BSPT

Racor en codo rosca cónica BSPT

W-Einschraubverschr. BSPT kon. - WE-R (KEG)

Raccord union coude mâle gaz conique



TUBO PIPE	ROSCA THREAD	Referencia Part n°	€
1/4"	1/4"	ZKLM0404	*
1/4"	3/8"	ZKLM0406	*
1/4"	1/2"	ZKLM0408	*
3/8"	3/8"	ZKLM0606	*
3/8"	1/2"	ZKLM0608	*
1/2"	1/2"	ZKLM0808	*
6	1/4"	ZKLM06M04	*
6	1/2"	ZKLM06M08	*
8	3/8"	ZKLM08M06	*
8	1/2"	ZKLM08M08	*
10	1/4"	NEW ZKLM10M04	999,00
10	3/8"	ZKLM10M06	*
10	1/2"	ZKLM10M08	*
16	1/4"	NEW ZKLM16M04	*
16	3/8"	NEW ZKLM16M06	*
16	1/2"	NEW ZKLM16M08	*
16	3/4"	NEW ZKLM16M12	*
22	3/4"	NEW ZKLM22M12	999,00
22	1"	NEW ZKLM22M16	*

Male stud branch TEE NPT

Racor en T rosca cónica NPT

T-Einschraubverschr. NPT (T-NPT)

Raccord TÉ mâle NPT au centre



TUBO PIPE	ROSCA THREAD	Referencia Part n°	€
1/8"	1/8"	ZKTMP0202	*
1/8"	1/4"	ZKTMP0204	*
1/4"	1/8"	ZKTMP0402	*
1/4"	1/4"	ZKTMP0404	*
3/8"	1/4"	ZKTMP0604	*
3/8"	3/8"	ZKTMP0606	*
1/2"	3/8"	ZKTMP0806	*
1/2"	1/2"	ZKTMP0808	*
6	1/8"	ZKTMP06M02	*
6	1/4"	ZKTMP06M04	*
8	1/8"	ZKTMP08M02	*
8	1/4"	ZKTMP08M04	*
10	1/4"	ZKTMP10M04	*
10	3/8"	ZKTMP10M06	*
12	1/4"	ZKTMP12M04	*
12	3/8"	ZKTMP12M06	*
12	1/2"	ZKTMP12M08	*

TWIN FERRULE FITTINGS TRALE® LOK

Racor Doble Anillo TRALE LOK
 Verschraubungen für Doppelklemmring TRALE LOK
 Raccords double bague TRALE LOK

Male stud barrel TEE NPT

Racor en L rosca cónica NPT

L Einschraubverschraubung NPT

Raccord Té mâle NPT latéral Inox



TUBO PIPE	ROSCA THREAD	Referencia Part n°	€
1/8"	1/8"	ZKTLMP0202	*
1/8"	1/4"	ZKTLMP0204	*
1/4"	1/8"	ZKTLMP0402	*
1/4"	1/4"	ZKTLMP0404	*
3/8"	1/4"	ZKTLMP0604	*
3/8"	3/8"	ZKTLMP0606	*
1/2"	3/8"	ZKTLMP0806	*
1/2"	1/2"	ZKTLMP0808	*
6	1/8"	ZKTLMP06M02	*
6	1/4"	ZKTLMP06M04	*
8	1/8"	ZKTLMP08M02	*
8	1/4"	ZKTLMP08M04	*
10	1/4"	ZKTLMP10M04	*
10	1/2"	ZKTLMP10M08	*
12	1/4"	ZKTLMP12M04	*
12	3/8"	ZKTLMP12M06	*
12	1/2"	ZKTLMP12M08	*

Straight bulkhead coupling- NPT

Racor recto - NPT pasatabique con tuerca

Gerade Schottkupplung - NPT

Raccord droit union double passe cloison avec écrou - NPT



TUBO PIPE	ROSCA THREAD	Referencia Part n°	€
1/8"	1/8"	ZKIBP0202	*
1/4"	1/4"	ZKIBP0404	*
3/8"	3/8"	ZKIBP0606	*
1/2"	1/2"	ZKIBP0808	*
3/4"	3/4"	ZKIBP1212	*
1"	1"	ZKIBP1616	*
6	1/8"	ZKIBP06M02	*
8	1/4"	ZKIBP08M04	*
10	3/8"	ZKIBP10M06	*
12	1/2"	ZKIBP12M08	*

Straight bulkhead coupling

Racor recto pasatabique con tuerca

Gerade Schottverschraubung

Raccord droit union double passe cloison avec écrou



TUBO PIPE	Referencia Part n°	€
1/8"	ZKIB02	28,30
1/4"	ZKIB04	30,55
5/16"	ZKIB05	*
3/8"	ZKIB06	*
1/2"	ZKIB08	50,15
5/8"	ZKIB10	*
3/4"	ZKIB12	*
1"	ZKIB16	*
6	ZKIB06M	*
8	ZKIB08M	*
10	ZKIB10M	*
12	ZKIB12M	*
15	ZKIB15M	*
16	ZKIB16M	*
18	ZKIB18M	*
20	ZKIB20M	*
25	ZKIB25M	*

TWIN FERRULE FITTINGS TRΔLE® LOK

Racor Doble Anillo TRΔLE LOK
Verschraubungen für Doppelklemmring TRΔLE LOK
Raccords double bague TRΔLE LOK

Female stud coupling NPT

Racor recto hembra rosca NPT

Einschraubkupplung NPT

Raccord union simple femelle NPT



TUBO PIPE	ROSCA THREAD	Referencia Part n°	€
1/8"	1/8"	ZKIHP0202	15,90
1/8"	1/4"	ZKIHP0204	17,45
1/8"	3/8"	ZKIHP0206	19,25
1/8"	1/2"	ZKIHP0208	22,25
1/4"	1/8"	ZKIHP0402	16,80
1/4"	1/4"	ZKIHP0404	18,45
1/4"	3/8"	ZKIHP0406	19,55
1/4"	1/2"	ZKIHP0408	23,60
3/8"	1/8"	ZKIHP0602	18,45
3/8"	1/4"	ZKIHP0604	19,65
3/8"	3/8"	ZKIHP0606	21,20
3/8"	1/2"	ZKIHP0608	25,30
3/8"	3/4"	NEW ZKIHP0612	42,10
1/2"	1/8"	ZKIHP0802	24,55
1/2"	1/4"	ZKIHP0804	24,55
1/2"	3/8"	ZKIHP0806	25,40
1/2"	1/2"	ZKIHP0808	29,65
5/8"	1/2"	ZKIHP1008	*
3/4"	1/2"	NEW ZKIHP1208	45,60
3/4"	3/4"	ZKIHP1212	79,50
1"	3/4"	NEW ZKIHP1612	76,00
1"	1"	ZKIHP1616	126,00
6	1/8"	ZKIHP06M02	16,65
6	1/4"	ZKIHP06M04	18,30
6	3/8"	ZKIHP06M06	19,50
6	1/2"	ZKIHP06M08	24,15
8	1/8"	NEW ZKIHP08M02	19,15
8	1/4"	ZKIHP08M04	19,15
8	3/8"	ZKIHP08M06	20,35
8	1/2"	ZKIHP08M08	24,65
10	1/4"	ZKIHP10M04	20,10
10	3/8"	ZKIHP10M06	21,40
10	1/2"	ZKIHP10M08	25,60
12	1/4"	ZKIHP12M04	25,00
12	3/8"	ZKIHP12M06	25,00
12	1/2"	ZKIHP12M08	29,15
16	1/2"	ZKIHP16M08	*
20	3/4"	ZKIHP20M12	66,60
22	3/4"	ZKIHP22M12	*
25	3/4"	NEW ZKIHP25M12	77,30
25	1"	ZKIHP25M16	85,10
2"	2"	NEW ZKIHP3232	*

Válvulas de instrumentación

Válvulas de aguja, Manifold, Antirretornos y
Válvulas limitadoras de presión

BAJO CONSULTA

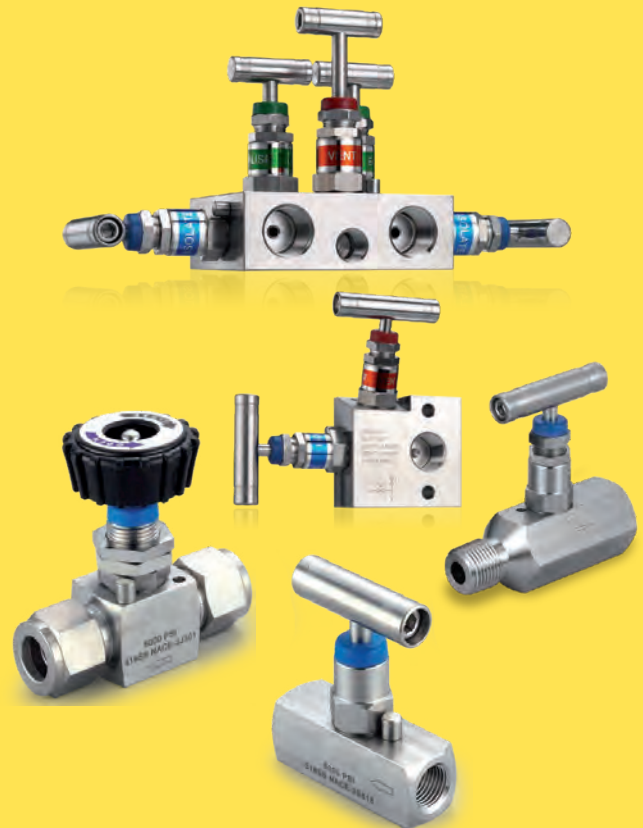

Instrument Valve

Needle Valve, Manifold,
Check and Proportional Relief Valve

ON REQUEST

TWIN FERRULE FITTINGS TRALE® LOK

Racor Doble Anillo TRALE LOK
Verschraubungen für Doppelklemmring TRALE LOK
Raccords double bague TRALE LOK

UNF plug closure

Tapón de cierre hembra UNF

UNF Verschlusskappe

Bouchon de fermeture Femelle UNF



TUBO PIPE	Referencia Part n°	€
1/8"	ZKOH02	*
1/4"	ZKOH04	*
5/16"	ZKOH05	*
3/8"	ZKOH06	*
1/2"	ZKOH08	*
5/8"	ZKOH10	*
3/4"	ZKOH12	*
1"	ZKOH16	*
6	ZKOH06M	*
8	ZKOH08M	*
10	ZKOH10M	*
12	ZKOH12M	*
14	ZKOH14M	*
15	ZKOH15M	*
16	ZKOH16M	*
18	ZKOH18M	*
20	ZKOH20M	*
22	ZKOH22M	*
25	ZKOH25M	*

UNF cap hexagon

Tapón hexagonal macho UNF

UNF-Sechskantstecker

Bouchon mâle hexagonale UNF



TUBO PIPE	Referencia Part n°	€
1/8"	ZKOM02	*
1/4"	ZKOM04	22,57
5/16"	ZKOM05	*
3/8"	ZKOM06	*
1/2"	ZKOM08	33,65
5/8"	ZKOM10	*
3/4"	ZKOM12	62,81
1"	ZKOM16	92,25
6	ZKOM06M	12,60
8	ZKOM08M	13,75
10	ZKOM10M	15,25
12	ZKOM12M	*
14	ZKOM14M	*
15	ZKOM15M	39,05
16	ZKOM16M	*
18	ZKOM18M	*
20	ZKOM20M	*
22	ZKOM22M	*
25	ZKOM25M	*

Tube end reducer

Racor de Reducción tubo

Reduzier-Verschraubung

Raccord de réduction



TUBO PIPE	Referencia Part n°	€
1/4"	ZKIA0402	*
3/8"	ZKIA0604	*
1/2"	ZKIA0806	*
3/4"	ZKIA1208	*
8	ZKIA08M06M	*
10	ZKIA10M08M	*
12	ZKIA12M10M	*
16	ZKIA16M12M	*

Male NPT adaptor

Adaptador macho NPT

NPT-Steckeradapter

Adapteur Mâle NPT



TUBO PIPE	ROSCA THREAD	Referencia Part n°	€
1/8"	1/8"	ZKIAMP0202	*
1/4"	1/4"	ZKIAMP0404	*
3/8"	3/8"	ZKIAMP0606	*
1/2"	1/2"	ZKIAMP0808	*
6	1/8"	ZKIAMP06M02	*
8	1/4"	ZKIAMP08M04	*
10	1/4"	ZKIAMP10M04	999,00
10	3/8"	ZKIAMP10M06	*
10	1/2"	ZKIAMP10M08	999,00
12	1/2"	ZKIAMP12M08	*

Female NPT adaptor

Adaptador hembra NPT

NPT-Adapterbuchse

Adapteur Femelle NPT



TUBO PIPE	ROSCA THREAD	Referencia Part n°	€
1/8"	1/8"	ZKIAHP0202	*
1/4"	1/4"	ZKIAHP0404	*
3/8"	3/8"	ZKIAHP0606	*
1/2"	1/2"	ZKIAHP0808	*
6	1/8"	ZKIAHP06M02	*
8	1/4"	ZKIAHP08M04	*
10	3/8"	ZKIAHP10M06	*
12	1/2"	ZKIAHP12M08	*

SOLICITE NUESTRAS **TARIFAS GENERALES** DE PRECIOS



Conducciones Hidráulicas y Neumáticas
Hydraulic and Pneumatic Connectors

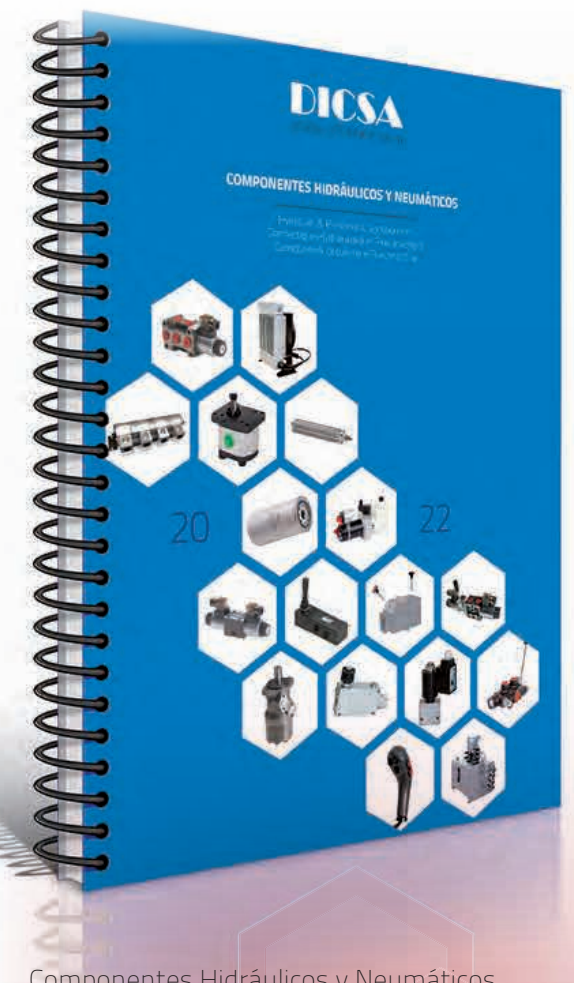

Componentes Hidráulicos y Neumáticos
Hydraulic and Pneumatic Components

PLEASE,
ASK FOR OUR
GENERAL PRICE LISTS

General conditions of sale

Condiciones de venta

GENERAL TERMS

These conditions, together with the eventual specific conditions accorded in the contract, apply to all deliveries and all services. The purchase conditions of the customer, if different from those herein established, will not be part of the contract on having accepted the order.

The contracts are concluded, unless otherwise agreed upon by the Parties in writing, by means of written confirmation of the supplier. The General Conditions and / or Specific Conditions of Purchase of the Buyer, cannot, in no case, cancel or replace these General Conditions of Sale.

The acceptance of our offers implies tacitly the acceptance of all the conditions detailed herein, except the special ones that have the agreement in writing, particularly in the same offer or detailed in our accuse of receipt of order, the only documents that oblige us before the Customer. DICSA has the right of property and the right of intellectual property of samples, budgets, technical documentation and information in material or immaterial form as well as in electronic form; the access of third parties to these documents must be forbidden.

OFFERS AND ORDERS

Except in case of having expressed the opposite, the prices include the merchandise placed in our store, including its loading, but without including the packing northtransporttotheplaceofreceipt, nortaxes, northegettingstarted- thesewill alwaysbeattheexpenseofthecustomer. Alltheoperationsoftransport, insurance, handling and delivery are on the account and risk of the Customer.

The offers include only the materials and products expressed in them, available in stock until end of stock, with the term of validity expressed in the same offers.

The studies or offers of material are based on the prices on the date the offer was made, and if, due to changes in the cost of the materials, modification of duties or to any other reason, the level of prices was checked, the prices that would be applied would be those that apply in the date of the delivery, unless the offer is accepted in the term of validity expressed in it.

The prices do not include, unless specific notification, the assembly and the getting started of the supplied materials, the fluids recommended by the technical services of the suppliers, the containers of the materials, as well as the study of the setting up of the different materials. DICSA may change the price, as a consequence of any law that concerns materials, wages, or the working hours, but also as a consequence of probable changes in the parity of the currency since it concerns the elements of import.

The orders will not be taken in consideration unless they are provided with the specific amount in our account, foreseen in our Offer, if this condition has been pre-established. The acceptance of the Offer will suppose equally the acceptance without reserve of these General Conditions of Sale.

STUDIES, TECHNICAL DOCUMENTATION

The information related to the offer, as technical documentation, designs, drawings, catalogues and / or any other technical documentation, is only informative and they have as object to give a general image of the materials described in them, they do not form a part of the contract unless written agreement. DICSA will not accept any type of responsibility for inaccuracy or omission of the above mentioned documentation.

The Customer will always have to do a previous study of compatibility and of assembly of the elements in his installation and will be the only responsible for the putting in conformity of the above mentioned installation with the current regulations. In offers, drawings, schemes and other technical information, we reserve ourselves the right of property and of design, not allowing that these should be facilitated to third parties without our previous written assent.

DICSA retains the property of the supplied merchandise until full payment of the agreed price. DICSA also retains the property of the Product's project, which in no circumstances shall be disclosed or sold to third parties.

THE ASSEMBLIES AT THE LOCATION (PLANT) OF THE CUSTOMER

The offers of the assemblies done for the customer, in his elected location of work, are considered as an estimate (approximate calculation), due to the particular and special characteristics that they can represent, not being able to give place, except final agreement between the parts, to final prices.

REPAIRMENT

The works of repair will not begin until written acceptance, on the part of the Customer, of the offer and of the conditions established in it. Supposing that the offer is not accepted by the Customer within one month, the expenses derived from the disassembly, storage, survey and freightage will be chargeable to the Customer. If the Customer requests the repair before accepting the offer, the assemblies will be carried out as soon as possible and, for his part, the Customer will have to accept the final cost of the repair.

In case of delivery of new products in exchange for the repair, if this one was out of guarantee, the Customer will have to accept the payment corresponding to it. The budgets of repair are always as estimation and should not be considered as final prices.

GENERALIDADES

Estas condiciones así como las eventuales condiciones especiales acordadas en el contrato rigen para todas las entregas y todas las prestaciones. Las condiciones de compra del cliente que sean distintas a las aquí establecidas no llegarán a formar parte del contrato al aceptar el pedido. Los contratos se celebran, salvo en el caso de que se haya acordado lo contrario, mediante confirmación escrita del proveedor. En ningún caso, las Condiciones Generales y/o Específicas de Compra del Comprador, anularán o sustituirán estas Condiciones Generales de Venta.

La aceptación de nuestras ofertas implica tácitamente la de todas las condiciones aquí detalladas, salvo las especiales acordadas por escrito, particularmente en la misma Oferta o detalladas en nuestro accuse de recepción de pedido, únicos documentos que nos obligan ante el Cliente.

DICSA se reserva el derecho de propiedad y el derecho de propiedad intelectual de muestras, presupuestos, planos e información en forma material o inmaterial así como en forma electrónica; el acceso de terceros a éstos ha de impedirse.

OFERTAS Y PEDIDOS

Los precios se entienden, caso de no expresar lo contrario para mercadería situada en nuestro almacén, incluyendo el cargado de ésta, pero sin incluir el embalaje ni el transporte al lugar de recepción, ni impuestos –que serán siempre a cargo del comprador–, así como tampoco la puesta en marcha en el emplazamiento. Todas las operaciones de transporte, seguro, manutención y entrega son a cuenta y riesgo del Comprador.

Las ofertas incluyen solamente los materiales y artículos en ellas especificados disponibles en stock salvo agotamiento y por el plazo de validez determinado en las mismas.

Los estudios u ofertas de material están basados en los precios vigentes en la fecha de su realización, y si, debido a alteraciones en el coste de los materiales, modificación de aranceles o a cualquier otra causa, el nivel de precios fuese revisado, los precios que se aplicarían serían aquellos que rijan en la fecha del suministro, a menos que la oferta sea aceptada dentro del plazo de validez que en la misma se fije.

Los precios no incluyen, excepto notificación expresa, el montaje y la puesta en marcha de los materiales suministrados, los fluidos recomendados por los servicios técnicos de los fabricantes, los contenedores tanto rígidos como elásticos de los materiales, así como el estudio de implantación de los distintos materiales.

DICSA podrá variar el precio, como consecuencia de cualquier ley que afecte a materiales, salarios o a las horas de trabajo y también a posible cambios en la paridad de la moneda, en elementos de importación.

Los pedidos no serán tomados en consideración a menos que vengan acompañados de la cantidad a cuenta prevista en nuestra Oferta, si así se ha establecido.

La aceptación de la Oferta supondrá igualmente la aceptación sin reservas de estas Condiciones Generales de Venta.

ESTUDIOS, PLANOS Y DISEÑOS

La información relacionada con la oferta, tal como planos, diseños, dibujos catálogos y/u otra documentación técnica, es solamente informativa y tienen como objeto dar una imagen general de los materiales en ellos descritos, no formando parte del contrato a menos que haya habido algún acuerdo por escrito. DICSA no aceptará ningún tipo de responsabilidad por la inexactitud u omisión de dicha documentación.

El Cliente deberá hacer siempre un estudio previo de compatibilidad y de montaje de los elementos en su instalación y será el único responsable de la puesta en conformidad de dicha instalación con las distintas reglamentaciones vigentes.

En presupuestos, planos, esquemas y otras informaciones técnicas, mantendremos reservado el derecho de propiedad y de realización, no permitiendo que estos sean facilitados a terceros sin nuestro previo consentimiento escrito.

DICSA se reserva el derecho de propiedad de la mercancía suministrada hasta el pago completo del precio establecido. DICSA se reserva el derecho de propiedad de los planos de la mercancía, que no serán facilitados ni vendidos a terceros en ningún caso.

TRABAJOS IN SITU

Los presupuestos de los trabajos realizados en el lugar de la obra del cliente son considerados orientativos, debido a las características particulares y especiales que pueden representar, no pudiendo dar lugar, excepto acuerdo definitivo entre las partes, en precios definitivos.

REPARACIÓN

Los trabajos de reparación no se empezarán hasta la aceptación escrita, por parte del Cliente, del presupuesto y de las condiciones que se establezcan.

En el supuesto de que el presupuesto no sea aceptado por el Cliente en el plazo de un mes, los gastos derivados del desmontaje, almacenaje, peritaje y portes correrán a cargo del Cliente. Si el Cliente solicita la reparación antes de aceptar el presupuesto, los trabajos se llevarán a cabo lo antes posible y, por su parte, el Cliente deberá aceptar el coste final de la reparación.

General conditions of sale

Condiciones de venta

DELIVERY TERMS

DICSA saves itself the right to reject an order depending on the availability of the products. In this supposition, DICSA will communicate it to the Customer as promptly as possible.

The delivery time has to be approved by the contractual parts. The delivery time will be calculated from the date of receipt of the confirmation of the order, when DICSA will be able to proceed without any interruption. DICSA will not be responsible for the delays in the supply of all or in part of the goods in case of major force, such as natural catastrophes, legal limitations, strikes, etc., or any other reason beyond our control. In case of any of the reasons previously mentioned, the period of delivery will be extensible to the same period of time that lasts the reason that has motivated the delay. Nevertheless, if the period exceeds six months, DICSA may cancel the part that couldn't be sent, by previously notifying the Customer in writing.

We do our best to respect the delivery times that are indicated in our offers or in our order confirmations, though it is materially impossible to answer completely for the above mentioned fulfillment, since we depend on other suppliers and on unexpected circumstances totally foreign to our possible control. Won't be accepted any sanctions for the delay in the foreseen delivery.

RIGHT OF PROPERTY

DICSA maintains the property of the materials (products) until the Customer makes the payment in full of the merchandise.

The Customer is responsible for taking the necessary actions to preserve in good condition the merchandise until it has been paid, must insure DICSA of the payment of the same one in case of having being sold to third persons by the Customer.

WARRANTY

We won't attend any claim done after the 12 months following the delivery of the merchandise. Returned material will not be allowed without previous authorization or when the time between the purchase and the request for return exceeds 15 days.

In any case, all returned merchandise will have to be accompanied by a copy of our authorization and, providing that it is not for reasons attributable to DICSA, will carry a minimal surcharge of 20 % on the cost of the returned material, all the expenses will be charged to the customer. Concerning the faults that appear in the supplied products, DICSA will only accept as unique responsibility or obligation, the paying of the product or defective products providing that the products (merchandise) have been treated adequately and that the arisen faults are due to faults of material or manufacture.

The warranty includes the replacement or repair of the defective elements in our workshops. The warranty is understood always in relation with the presumably defective material deposited in our warehouse, but the costs of transport and the risk being at the expense of the Customer. The advices given before and post closing of the contract, are made with the best intention and according to our know-how, nevertheless DICSA does not assume any category of responsibilities in this regard, nor will answer of the eventual direct or indirect damages that could take place indistinctly, no matter who, where and why they may take place.

DICSA will not be responsible for any consequence or indirect damages occurred to the Customer, and / or third Parties including but not limited to loss of opportunities, business and incomes.

DICSA guarantees exclusively its own materials, excluding any responsibility for the effects or damages that these could provoke in facilities, equipments or conductions. In no case will take responsibility for accidents related to individuals or materials or for losses in fabrication.

The warranty excludes the breakdowns produced by badly use or deficient installation, breakdowns provoked by overloading of the equipments for experimental purposes, either for adjustment or testing. DICSA's total responsibility for the caused damages, independently of the type of action or theory of the responsibility, will not exceed the amount of the work done, installation or materials that have been object of the order to DICSA.

Any amount that exceeds the above mentioned quantity, and any amount that DICSA will have to support either for judicial, arbitral or similar decision, will be transmitted to the Customer until obtaining indemnity.

Will be excluded from this warranty:

- The use of facilities or services, which are different of those included in the manuals of instruction or in DICSA's specifications.
- The inadequate use of facilities or negligence of the Customer, his Assistants or Agents.
- The parts supplied by the Customer.

En caso de entregarse productos nuevos a cambio de la reparación, si esta estuviera fuera de garantía el Cliente deberá aceptar el cargo correspondiente a la misma.

Los presupuestos de reparación siempre son orientativos y en ningún caso deben tomarse como precios finales.

PLAZOS DE ENTREGA

DICSA se reserva la facultad de rechazar un pedido en función de la disponibilidad de los productos. En este supuesto, lo comunicara al comprador con la mayor brevedad posible.

El plazo de entrega será acordado por las partes contractuales. Los plazos de entrega se calcularán desde la fecha de recepción de la confirmación del pedido, pudiendo DICSA proceder sin interrupción alguna. DICSA no será responsable de las demoras en el suministro de toda o parte de la mercancía en el caso de fuerza mayor, tal como catástrofes naturales, limitaciones legales, huelgas, etc., o cualquier otra causa fuera de nuestro control. En el caso de darse alguna de las razones anteriormente citadas, el periodo de entrega se hará extensible al mismo periodo de tiempo que dure la causa que haya motivado el retraso. Sin embargo, si el periodo excediera de seis meses, DICSA podrá cancelar la parte no enviada notificando previamente por escrito al comprador.

Procuramos con el mayor interés, cumplir los plazos de entrega que se indican en nuestras ofertas o en nuestras confirmaciones de pedido, si bien es materialmente imposible responder plenamente de dicho cumplimiento, por depender de otros proveedores y de inesperadas circunstancias totalmente ajenas a nuestro posible control.

De ahí que no se aceptarán sanciones por demora en la entrega prevista.

DERECHO DE PROPIEDAD

DICSA mantiene la propiedad de la mercancía hasta que el comprador realice el pago por completo de la misma.

Será responsabilidad del comprador tomar las medidas necesarias para conservar en buen estado la mercancía hasta que haya sido pagada, debiendo asegurarse a DICSA el cobro de la misma en caso de haber sido vendida a terceras personas por el comprador.

GARANTÍA

No se responderá de ninguna reclamación que no sea efectuada dentro de los 12 meses siguientes a la entrega de la mercancía, ni se aceptarán devoluciones sin autorización previa o pasados 15 días desde la entrega de la mercancía. En cualquier caso, toda devolución deberá ir acompañada de copia de nuestra autorización y, siempre que no sea por causas imputables a DICSA, conllevará un recargo mínimo del 20 % sobre el coste del material devuelto, corriendo todos los gastos a cargo del cliente.

En relación con los defectos que aparezcan en los productos suministrados, DICSA aceptará como única responsabilidad u obligación, abonar la pieza o piezas defectuosas siempre que la mercancía haya sido tratada adecuadamente y que los defectos surgidos sean debidos a defectos de material o fabricación.

La garantía comprende la reposición o reparación de los elementos defectuosos a realizar en nuestros talleres.

La garantía se entiende siempre con el material presumiblemente defectuoso depositado en nuestras instalaciones, con los gastos de transporte y riesgo a cargo del comprador.

Los consejos y asesoramiento dados antes y post cierre del contrato, se realizan con la mejor intención y según nuestros máximos conocimientos, no obstante DICSA no asume ninguna clase de responsabilidades a este respecto, ni responderá de los eventuales daños directos o indirectos que indistintamente, por quién, dónde y por qué puedan producirse.

DICSA no será responsable de ninguna consecuencia o ningún daño indirecto producido al Comprador o a terceros, incluyendo los daños de pérdida de oportunidades, negocio o ingresos.

DICSA garantiza exclusivamente sus materiales excluyendo cualquier responsabilidad por los efectos o perjuicios que estos puedan provocar en instalaciones, maquinarias o circuitos. En ningún caso se responsabilizará de los accidentes personales o materiales y pérdidas de producción.

Se excluye de la garantía las averías producidas por mal uso o deficiente instalación, averías provocadas por sometimiento de los equipos a esfuerzos anormales con fines experimentales, de ajuste o prueba. La total responsabilidad de DICSA por los daños causados, independientemente del tipo de acción o teoría de la responsabilidad, no excederá del importe de la obra, instalación o materiales que haya sido objeto de pedido a DICSA. Cualquier importe que supere dicha cantidad y que DICSA se vea obligada a soportar ya sea por decisión judicial, arbitral o similar, será repetida a la compradora hasta lograr indemnidad.

Se encuentran excluidos de esta garantía:

- *El uso de instalaciones o servicios, que se aparten de los manuales de instrucción o especificaciones de DICSA.*
- *El uso inadecuado de instalaciones o negligencia del Comprador, sus Ayudantes o Agentes.*
- *Las partes suministradas por el Comprador.*

General conditions of sale

Condiciones de venta

FREIGHTAGES

By merchandise we always mean the one deposited in DICSA's warehouse, even in operations conditioned by the delivery at destination and the merchandise will always travel at the account and risk of the Customer, being at his charge, including the additional insurances that could be established and the special permissions it may need. According to what it is established in the article 18 of the Royal decree 782/1998 concerning wrapping and packaging mentioned in the 1st additional Disposition (Regulation) of the Law 11/1997, the person responsible for the delivery of the residues of the packaging and worn packages, for the correct environmental management, will be the final user.

EMERGENCY DELIVERIES

No matter the type of the transportation used: by plane, courier, as baggage (luggage), special agencies, messengers etc; independently of the amount of the above mentioned service, the Customer will pay all the extra expenses, those of transportations, of shipping, and of communications that the service has caused; this value may not, under no circumstance, be lower than 60 euros.

SPECIAL ORDERS

Any order (request) of special material, will carry the anticipated payment of 50 % of the amount of the order (request), as an indispensable condition for its acceptance. The above mentioned amount will always be in favor of DICSA as compensation in case of cancellation on the part of the Customer, without prejudice of the claims at which they may have right by Law.

MINIMAL SALE

The minimal invoice will be of 50 €, no matter the amount of the order.

PAYMENTS

The payments have to be done, except express written agreement between the parts, in maximum 60 days from the date of the invoice and previous receipt of the positive reports of credit. If the Customer doesn't make the payment in time, for a part of the merchandise supplied, DICSA is authorized to suspend the posterior deliveries until the Customer executes the due payments. Any bank charges associated with the payment of the merchandise, as well as the expenses of return of it in case of non-payment, will be at the expense of the Customer. In case of delay in the payment and without prejudice of other rights attributed to the buyer for the legislation in effect, the Customer will pay to DICSA an interest of monthly delay of 2 % starting from the date when the invoice comes to its term.

UNPAID OR POST-PONED INVOICES

Will be at the expense of the Customer:

- The return expenses.
- Monthly interests of 1 %, from the day when the payment has come to its term and wasn't made, until the date of full payment.
- Possible amount (value) of the stamp of the new documents.
- The credit insurance.

COINCIDENTAL PAYMENTS IN VACATIONS

If the client could not attend to the payments that were coinciding with vacation periods, these will move to the same day of the previous month. In case there are fixed days of payment, the term of the invoice will move to the immediately previous working day of payment.

THE SOFTWARE USE

If the delivery includes the putting at the disposal of the Customer software, the Customer has the exclusive right to use it, including the attached documentation. The software is sent for the use in the object of delivery to which it is destined. It is forbidden the use of this software into any other system. The modification, translation or adjustment of the code of object to code of origin as well as the reproduction of software is only admitted into the legally established limits. The Customer promises not to withdraw the indications of the manufacturer, especially the indications of the Copyright, without DICSA's previous assent. All the other rights on the software and the documentation including the copies, they belong to DICSA or to the supplier of the software. The concession of sublicenses is not admitted.

GOVERNING LAW AND JURISDICTION

These General Conditions and any agreement between DICSA and the Customer shall be exclusively governed by Spanish laws. The exclusive jurisdiction on any dispute between the DICSA and the Customer shall be the courts of DICSA's domicile. Nevertheless, DICSA has also the right to bring legal action against the Customer before the courts of the place of business and/or residence of the Customer.

PORTES

La mercancía se entiende siempre depositada en el domicilio de DICSA, incluso en operaciones condicionadas a la entrega en destino y la mercancía siempre viajará por cuenta y riesgo del comprador, siendo a su cargo inclusive los seguros adicionales que pudieran establecerse y los permisos especiales a que hubiera lugar.

Según se establece en el artículo 18 del Real Decreto 782/1998 para los envases y embalajes acogidos a la Disposición adicional 1.ª de la Ley 11/1997, el responsable de la entrega de los residuos de los embalajes y envases usados, para su correcta gestión ambiental, será el usuario final.

ENVÍOS DE EMERGENCIA

Sea cual fuere el medio de transporte utilizado, avión, courier, régimen de equipajes, agencias especiales, mensajeros etc. Independientemente del importe de dicho servicio, el comprador correrá con todos los gastos extra, los de acarreo, de desplazamientos, y de comunicaciones que el servicio haya ocasionado, sin que en ningún caso este valor pueda ser inferior a 60 euros.

PEDIDOS ESPECIALES

Todo pedido de material especial, conllevará el pago anticipado del 50 % del importe del pedido, como condición indispensable para su aceptación. Dicho importe quedará siempre a favor de DICSA como indemnización en cualquier caso de anulación por parte del comprador, sin perjuicio de las reclamaciones que por Ley se puedan tener derecho.

VENTA MÍNIMA

La facturación mínima será de 50 € sea cual sea el importe del pedido.

PAGOS

Los pagos se realizarán como máximo y salvo acuerdo expreso entre las partes, a 60 días desde la fecha de la factura y previa recepción de los informes positivos de crédito. Si el comprador no efectuare el pago de cualquiera de los suministros a su vencimiento, DICSA está autorizado a suspender los envíos posteriores hasta que se realice dicho pago. Cualquier cargo bancario asociado con el pago de la mercancía, así como los gastos de devolución de efectos en caso de impago, serán por cuenta del comprador.

En caso de demora en el pago y sin perjuicio de otros derechos atribuidos al comprador por la legislación en vigor, el comprador abonará a DICSA un interés de demora del 2 % mensual desde la fecha de vencimiento de la factura.

COBRO DE LETRAS O RECIBOS DEVUELTOS O APLAZADOS

Serán a cargo del librado:

- Gastos de devolución.
- Intereses del 1 % mensual desde el día del vencimiento fallido hasta la fecha de cobro definitivo.
- Posible valor del timbre de nuevos documentos.
- Prima de seguro de crédito.

PAGOS COINCIDENTES EN VACACIONES

Si el cliente no pudiese atender los pagos que coincidiesen con periodos vacacionales, éstos se trasladarán al mismo día del mes anterior. En caso de existir días fijos de pago, el vencimiento se trasladará al día hábil de pago inmediatamente anterior.

USO DE SOFTWARE

En la medida en que el volumen de entrega incluye la puesta a disposición de software, el cliente tiene el derecho no exclusivo a usarla incluyendo la documentación adjunta. Se le cede el software para el uso en el objeto de entrega al cual va destinado. No se admite el uso de este software en otro sistema. La modificación, traducción o adaptación de código de objeto a código de origen así como la reproducción de software solamente se admite en la medida legalmente establecida. El cliente se compromete a no retirar las indicaciones del fabricante, especialmente indicaciones del Copyright sin el consentimiento previo de DICSA. Todos los demás derechos sobre el software y la documentación incluyendo las copias, corresponden a DICSA o al proveedor del software. No se admite la concesión de sublicencias.

DERECHO APLICABLE Y JURISDICCIÓN

Las relaciones jurídicas entre DICSA y el comprador están sujetas al derecho Español. El tribunal competente será el del domicilio de DICSA. Sin embargo, DICSA podrá optar por interponer las acciones legales correspondientes en el domicilio del comprador.

► Información general

General information

DICSA ESPAÑA

Sede | Head Office

Tel. +34 976 46 10 46
info@dicsaes.com

DICSA ITALIA SRL

Tel. +39 059 820 179
italia@dicsaes.com

DICSA AMERICA

Tel. 786 358 6662
america@dicsaes.com

DICSA DEUTSCHLAND

Tel. 0322 21098096
export@dicsaes.com

DICSA LATAM

Tel. +34 976 464 106
america@dicsaes.com

DICSA ASIA PACIFIC

Tel. +34 976 464 106
asia-pacific@dicsaes.com

DICSA TÜRKIYE

Tel. +90 533 080 67 08
turkiye@dicsaes.com

Atención al cliente | Customer service

Departamento comercial | Commercial department

Gestión de pedidos | Orders management

Nacional | National

Tel. 976 464 108
comercial@dicsaes.com

Internacional | International

Tel. +34 976 464 106
export@dicsaes.com

Nacional | National

Conducciones | Connectors
Tel. 976 464 100
976 464 101
Hidráulica | Components
Tel. 976 464 102
pedidos@dicsaes.com

Internacional | International

Tel. +34 976 464 100
+34 976 464 101
orders@dicsaes.com

Otros servicios | Other services

Dpto. Calidad | Quality Dpt.

Tel. 976 479 545
calidad@dicsaes.com

Dpto. Informática | IT Dpt.

Tel. 976 479 555
informatica@dicsaes.com

Dpto. Producción | Production Dpt.

Tel. 976 479 543
produccion@dicsaes.com

Dpto. Finanzas | Accounting Dpt.

Tel. 976 479 542
finanzas@dicsaes.com

Dpto. Compras | Purchasing Dpt.

Tel. 976 464 107
compras@dicsaes.com

Oficina de almacén | Warehouse Dpt.

Tel. 976 464 101
almacen@dicsaes.com

DICSA

info@dicsaes.com
www.dicsaes.com

DISTRIBUIDORA INTERNACIONAL CARMEN, S.A.U
Polígono Industrial Alcalde Caballero
C/ Virgen del Buen Acuerdo, s/nº. 50014 Zaragoza (Spain)
Tel. +34 976 46 10 46

DICSA ITALIA SRL
Via Emilia Ovest 1179/c
41123 Modena (Italia)
Tel. +39 059 820 179
italia@dicsaes.com

DICSA AMERICA LLC
875 NE 191 STR.
STE 302 Aventura. FL 33180
Tel. 786-358-6662
Skype: america.dicsa
Whatsapp: +34 617548815
america@dicsaes.com

DICSA DEUTSCHLAND
Logististihsentrum GmSH
Thomas Dachser Str. 1 ·
76316 Malsch (Alemania)
Tel. 322 21098 096
export@dicsaes.com

DICSA LATAM
Tel. +34 976 464 106
america@dicsaes.com

DICSA ASIA PACIFIC
Tel. +34 976 464 106
asia-pacific@dicsaes.com

DICSA TÜRKIYE
Tel. 90 533 080 67 08
turkiye@dicsaes.com

2022

