

FLEXZILLA®

PREMIUM HOSES, TOOLS & EQUIPMENT



AIR



WATER



POWER



LUBE



WORKWEAR

If it's not ZillaGreen®, it's not Flexzilla®

2022



THE FLEXZILLA® EDGE

Giving you the edge you deserve.

You work hard to get where you are in life. When it's time to choose the tools that help get you there, you deserve something that's above the ordinary. Tools that give you the edge you need to complete your projects faster, easier and with more satisfaction at the end of the day. You deserve Flexzilla hoses, tools and equipment.

**It's the difference between ordinary tools
and the innovative thinking designed
into every Flexzilla product.**

We take conventional tool ideas and rethink the work experience. The result is premium air, water and power tools that pull their weight and always put you a step ahead.

Experience it for yourself.

See how the innovative details we put into our tools make all the difference. Whether you're a professional or do-it-yourselfer, working with Flexzilla tools doesn't feel like work.



FLEXZILLA[®] by

leg

CONTENTS



7 Air Compressors

Stationary Air Compressors - Pressure Lubricated	8-9	Air Compressor Accessories	11
Stationary Air Compressors - Splash Lubricated	10	Portable Air Compressors	12
Refrigerated Air Dryers	11		

13 Air Hoses

Air Hose Assemblies	14	Pro Custom Hose Centers	19-20
Air Hose Kits	15-16	Pro Reusable Fittings and Splicers	21
Whip Hose Assemblies	16	Bulk Air and Water Hose	21
Polyurethane Recoil Hose	17	Pro Air Hose Assemblies	22
Hose Crimper	17	Pro Air Hose Kits	23
Pro Custom Air Hose	18	Pro Custom Length Whip Hose with High Flow Ball Swivel	23

24 Air Hose Reels

Retractable Air Hose Reels with Levelwind™ Technology	25	Retractable Air Hose Reels - Single Arm, Open Face	30
Mounting Brackets	25	Manual Air Hose Reels	31
Pro Retractable Air Hose Reel	26	Manual Air Hose Reels - Fixed, Heavy-Duty	32
Retractable Air Hose Reels	27	Manual Air Hose Reels - Portable	33
Retractable Air Hose Reels - Single Axle Arm Support	28	Lead-In Hoses	34
Retractable Air Hose Reels - Dual Axle Arm Support	29		

35 Air Line Accessories

Pro High Flow Couplers and Plugs	36-37	Pro Heavy Duty Safety Couplers and Plugs	39
Pro High Flow Coupler and Plug Kits	38	Pro Heavy Duty Safety Coupler and Plug Kits	40

41 Blow Guns

Modular Blow Guns	42	Modular Blow Guns Accessories System	43
Modular Blow Gun Kits	42		

44 Air Tools

Pro Mini Impact Wrench	45
----------------------------------	----

46 Tire Maintenance

Tire Inflators	47	Truck Tire Inflator Kit	47
--------------------------	----	-----------------------------------	----

WATER

Water Hoses

48

SwivelGrip® Garden and Lead-in Hose Assemblies	49	Garden Hose Nozzles	55-57
Garden Hose Merchandiser and Pallets	50	Lawn Sprinklers	57
Colors™ SwivelGrip Garden Hose Assemblies	50	Pro Water Hose Nozzles	57
Garden and Lead-in Hose Assemblies	51	Pro Custom Water Hose	58
Garden Hose Kit with Quick Connect Attachments	52	Pro Custom Water Hose Centers	59-60
3-Piece Nozzle Kit with Quick Connections	52	Pro Water Hose Assemblies	60
Quick-Connect Garden Hose Fittings	53	Retractable Water Hose Reel with Levelwind Technology	61
Marine Twin Outboard Flush Kit, 6-Piece	54	Mounting Brackets	61
2-Way Hose Splitter	54	Pressure Washer Hose Assemblies	62

POWER

Extension Cords

63

Pro Extension Cords	64	Pro Retractable Extension Cord Reel	66
Retractable Extension Cord Reels	65		

LUBE

Greasing Equipment

67

20V Cordless Grease Gun Kit	68	Quick-Release Grease Coupler	69
Lever Action Grease Gun	69	Grease Hoses	70

WORKWEAR

Work Gloves

71

Work Gloves	72-87
-----------------------	-------

Plan-O-Grams & Part Number Index

88

Plan-O-Grams	89-95	Part Number Index	96-99
------------------------	-------	-----------------------------	-------

ICONS

ICONS THROUGHOUT THE CATALOG IDENTIFY FLEXZILLA® FEATURES AND BENEFITS



Flexzilla® Air Hose

FEATURES:

- Extreme all-weather flexibility, even in subzero temperatures (-40° to 140°F)
- Won't kink under pressure
- Lightweight and easy to handle
- Lays flat - no memory
- Durable and abrasion-resistant outer cover
- Anodized aircraft aluminum ends
- Max. working pressure at 70°F: 300 psi
- Includes bend restrictors to reduce wear and tear, prolonging the life of the hose



Flexzilla® Water Hose

FEATURES:

- Extreme all-weather flexibility
- Durable outer cover resists abrasion, UV and mold
- Won't kink under pressure
- Lightweight and easy to handle
- Lays flat - no memory
- Reinforced mid-layering provides extra strength
- Anodized aircraft aluminum ends
- Leak-free connections - A durable O-ring provides long lasting leak-free connections
- Max. working pressure at 70°F: 150 psi



ColorConnex® Couplers & Plugs

ColorConnex is a patented system that allows color-to-color matching of couplers and plugs among the standard pneumatic interchanges.

- Industrial (Type D): Red
- Automotive (Type C): Blue
- ARO (Type B): Green

By using ColorConnex to dedicate line use, you can ensure you never use a lubricated line for a dry line application, preventing cross contamination.

- Match coupler and plug types
- Dedicate hose applications



Flexzilla® Pro Air Hose

FEATURES:

- Field Repairable – Reusable anodized aircraft aluminum fittings
- Extreme all-weather flexibility, even in subzero temperatures (-40° to 140°F)
- Won't kink under pressure
- Lightweight and easy to handle
- Lays flat - no memory
- Durable and abrasion-resistant outer cover
- Max. working pressure at 70°F: 300 psi
- Flexzilla Pro Reusable Fittings include bend reinforcement to reduce wear and tear, prolonging the life of the hose



Flexzilla® Pro Water Hose

FEATURES:

- Field Repairable – Reusable anodized aircraft aluminum fittings
- Extreme all-weather flexibility
- Lightweight, coils easily
- Won't kink under pressure
- Lays flat - no memory
- Durable outer cover resists abrasion, UV and mold
- Reinforced mid-layering provides extra strength
- Leak free connections - A durable O-ring provides long lasting leak free connections
- Max. working pressure at 70°F: 150 psi
- Flexzilla Pro Reusable Fittings include bend reinforcement for increased flexibility. Reduces wear and tear, prolonging the life of the hose.



Flexzilla® Pro High Flow Couplers and Plugs

Flexzilla Pro High Flow couplers and plugs allow Twice The Flow to your air tools compared to standard interchanges. Connect Flexzilla High Flow fittings from your tool all the way to the compressor. Don't Starve Your Air Tool!

- Push-To-Connect
- Increased efficiency
- Maximum Torque
- Maximum RPM
- Best Performance
- Ideal for spray guns and impact tools

Flexzilla® Pro

Flexzilla Pro Products are designed with the professional in mind



Drinking Water Safe

The Flexible Hybrid Polymer inner tube material makes many of our hoses drinking water safe





QUIET TECHNOLOGY™

Quiet Technology™, which uses large, low-RPM pumps and motors to reduce high frequency noise levels while increasing CFM output.

AIR COMPRESSORS

SILENCER™ NOISE SUPPRESSION

A patented noise suppression system that uses baffles to reduce low frequency noise.



SILENCER

FLEXZILLA
PRO



QUIET
TECHNOLOGY™



Stationary Air Compressors - Pressure Lubricated

PRO

Let's face it, standard air compressors are LOUD. All this NOISE interferes with workplace communication, lowers productivity on the job, and increases risk of hearing loss. Fortunately, Flexzilla® brings quiet back to the workplace.

QUIET TECHNOLOGY™

- Flexzilla air compressors are the quietest on the market, emitting operating noise no louder than a normal conversation
- Flexzilla air compressors feature low RPM pumps and motors that reduce high frequency noise levels while increasing CFM output

SILENCER™

- Flexzilla stationary air compressors include the Silencer™, a patented noise suppression system that reduces low frequency noise levels

INDUSTRY EXCLUSIVE!

10 HP RECIPROCATING UNIT / 1-PHASE

- High CFM performance without the cost of installing 3-Phase
- Output of more expensive screw units without the added cost



SILENCER™ NOISE SUPPRESSION

Patented

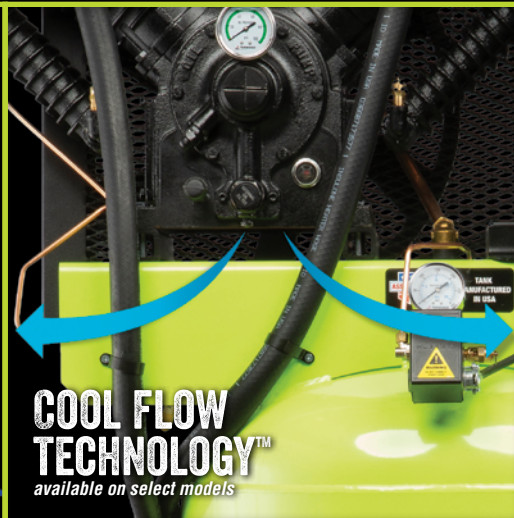
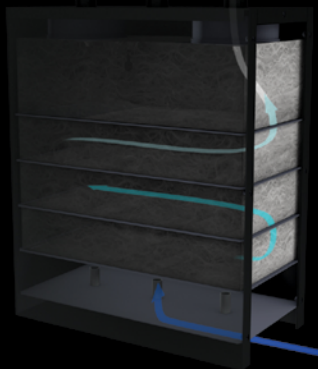

COOL FLOW TECHNOLOGY™

available on select models

10 HORSEPOWER SINGLE-PHASE

available on select models



Stationary Air Compressors - Pressure Lubricated

PRO



FS05V08011

5 HP



FXS07V080V1

7.5 HP



FXS10V120V1

10 HP

FLEXZILLA® PRO (5 HP) INCLUDES:

- Manual water drain
- Motor - open drip proof (ODP)
- 4 Year Warranty
 - 1 Year Parts and Labor Warranty
 - Additional 3 Year Extended Parts Warranty

FLEXZILLA® PRO (7.5 / 10 HP) INCLUDE:

- Cool Flow Technology™
- Timed water drain
- Belt tensioner
- Continuous run (Dual control)
- Totally enclosed fan cooled motor
- Magnetic starter - prewired
- Ball valve crank case oil drain
- 6 Year Warranty
 - 1 Year Parts and Labor Warranty
 - Additional 5 Year Extended Parts Warranty

Part No.	HP Spec	Tank Size (Gal.)	CFM @ 90 PSI	Max. PSI	Pump	Connection	Pump Pressure Lubed	Automatic Tank Drain	Belt Tensioner	Continuous Run	Cool Flow Technology™	Length (in.)	Width (in.)	Height (in.)	Assembled in USA	Tank Made in USA
Flexzilla® Pro Stationary Air Compressors, 5 HP																
FS05V08011	5	80	19	175	2-Cyl	1-Phase	●	-	-	-	-	42	33	75	●	●
Flexzilla® Pro Stationary Air Compressors, 7.5 HP																
FXS07V080V1	7.5	80	33	175	4-Cyl	1-Phase	●	●	●	●	●	38	42	72.5	●	●
FXS07V080V3-208	7.5	80	33	175	4-Cyl	3-Phase	●	●	●	●	●	38	42	72.5	●	●
FXS07V080V3-230	7.5	80	33	175	4-Cyl	3-Phase	●	●	●	●	●	38	42	72.5	●	●
Flexzilla® Pro Stationary Air Compressors, 10 HP																
FXS10V080V1	10	80	39	175	4-Cyl	1-Phase	●	●	●	●	●	38	42	72.5	●	●
FXS10V080V3-208	10	80	39	175	4-Cyl	3-Phase	●	●	●	●	●	38	42	72.5	●	●
FXS10V080V3-230	10	80	39	175	4-Cyl	3-Phase	●	●	●	●	●	38	42	72.5	●	●
FXS10V120V1	10	120	39	175	4-Cyl	1-Phase	●	●	●	●	●	41	43	78	●	●
FXS10V120V3-208	10	120	39	175	4-Cyl	3-Phase	●	●	●	●	●	41	43	78	●	●
FXS10V120V3-230	10	120	39	175	4-Cyl	3-Phase	●	●	●	●	●	41	43	78	●	●

Stationary Air Compressors - Splash Lubricated



FLEXZILLA® (5 / 7.5 / 10 HP) INCLUDE:

- Motor - Open drip proof (ODP)
- Automatic tank drain
- Heavy Steel OSHA Approved Belt Guards
- 4 Year Warranty
 - 1 Year Parts and Labor Warranty
 - Additional 3 Year Extended Parts Warranty

SINGLE PHASE ONLY, 3-PHASE MOTOR IS NOT AVAILABLE FOR SPLASH UNITS

Part No.	HP Spec	Tank Size (Gal.)	CFM @ 90 PSI	Max. PSI	Pump	Connection	Pump Splash Lubed	Automatic Tank Drain	Length (in.)	Width (in.)	Height (in.)	Assembled in USA	Tank Made in USA
Flexzilla® Stationary Air Compressors, 5 HP													
FS050V80Y1	5	80	16	175	2-Cyl	1-Phase	●	●	40	39	69	●	●
Flexzilla® Stationary Air Compressors, 7.5 HP													
FS07V080Y1	7.5	80	25	175	4-Cyl	1-Phase	●	●	40	40	69	●	●
Flexzilla® Stationary Air Compressors, 10 HP													
FS10V080V1	10	80	37	175	4-Cyl	1-Phase	●	●	38	43	73	●	●
FS10V120V1	10	80	37	175	4-Cyl	3-Phase	●	●	47	44	79	●	●

Refrigerated Air Dryers

PRO

Flexzilla™ Pro Refrigerated Air Dryers continuously chill the compressed air from your compressors to condense and remove moisture, leaving only powerful, compressed air your pneumatic tools require for best performance.

FEATURES:

- Premium Industrial Refrigerated Air Dryer
 - Chills the air to condense and remove moisture; runs on 115 Volt, single phase
 - 230 PSI max.; Max. inlet temp: 140°F; 37°F - 50°F dew point
 - Maximum ambient temperature: 122°F; for use with compressors that do not have aftercoolers
- 5 Micron Pre-Filter - Removes larger dust and dirt particles from the air supply so the dryer can work more efficiently
- 1 Micron Active Coalescing Filter - Removes oil and water Particles from the air; cleaner, drier air improves tool life & project results
- Refrigerated Air Inlet Inner Cooler - Trouble-free high temperature cooling for consistent dry air
- Automatic Drain System - Eliminates the need for daily maintenance
- Outlet Air Baffle Heater - Prevents condensation on outlet air piping
- Side Mounted Condenser and Fan Motor
 - Easy to reach and service through the cabinet doors- no screws to slow you down
 - Uses environmentally friendly 134A refrigerant
- Heavy Duty Steel Cabinet and Safety Shut-Off Valve - Meets the demands of industrial use; valve shuts the compressor down if it gets above or below a safe temperature

FDRCF1150030



FDRCF1150058

Part No.	Volt	CFM	HP Spec	Max. PSI	Inlet Fittings	Outlet Fittings
FDRCF1150030	115V	30	5 HP-7.5 HP	230 PSI	1/2 in. NPT	1/2 in. NPT
FDRCF1150058	115V	58	10 HP	230 PSI	1/2 in. NPT	1/2 in. NPT

Air Compressor Accessories

Part No.	Description	Retail Packaging	Assembled in USA
DRAIN013	Flexzilla™ Pro Air Compressor Timed Water Drain	–	–
FILTER057	Flexzilla™ Air Compressors Air Filter for 5-10 HP	–	●
FILTER107KIT	Flexzilla™ Air Compressor Silence™ Filter Replacements, Qty. 8	–	●
FILTERKIT011	Flexzilla™ Air Dryer Filter Maintenance Kit, for 30 CFM	–	–
FILTERKIT012	Flexzilla™ Air Dryer Filter Maintenance Kit, for 58 CFM	–	–
FKIT011A	Flexzilla™ Air Dryer Filter Maintenance Kit, for 30 CFM	–	–
FKIT026A	Smart Oil™ and Filter Maintenance Kit, 24-Piece, for 5-10 HP Air Compressors	–	–
ISOLATORS001	Flexzilla™ Air Compressors Isolator Pads, Qty. 4	–	–
MAINKIT008A	Flexzilla™ Air Compressors Oil and Filter Maintenance Kit, for 5-10 HP	–	●
OILFZ004	Flexzilla™ Air Compressor Oil, Synthetic, Piston-Type, 1 Qt.	●	●
OILPIS102Q	Smart Oil™ Whisper Blue Air Compressor Oil, Synthetic, 1 Qt.	●	●



MAINKIT008A



FILTER057



DRAIN013



FILTER107KIT



FILTERKIT011

Portable Air Compressors



QUIET TECHNOLOGY™

Flexzilla® Air Compressors are the quietest on the market, emitting operating noise no louder than a normal conversation. Flexzilla Air Compressors feature low RPM twin cylinder pumps and motors that reduce high frequency noise levels.



CF10050F

1 HP / 5 GAL.

FEATURES:

- Industrial Grade Pump
 - Premium components and copper windings that outlast aluminum
- Direct Drive Pump
- Oil-Free Pump
 - Reduces Maintenance
- Two Quick-Connect Universal Brass Couplers
- Pressure Regulator and Gauge
- Tank Pressure Gauge
- Manual Tank Drain
- Elastomeric Ergonomic Grip



CB20100F

2 HP / 10 GAL.

CF10050F FEATURES:

- Convenient top mounted controls

CB20100F & CB20200F FEATURES:

- Front mounted controls
- 8 in. oversize wheels - for ease of mobility



CB20200F

2 HP / 20 GAL.

Part No.	HP Spec	Tank Size	CFM @ 90 PSI	Max. PSI	Pump RPM	Pump	Power Source	Current Draw / Max. Amps	Oil-Free Pump	Direct Drive Pump	Retail Packaging
Flexzilla® Portable Air Compressors, 1 HP											
CF10050F	1 HP	5 Gal.	2.5 CFM	125 PSI	1702 RPM	2-Cyl	ELECTRIC	7 AMPS @ 115V	●	●	●
Flexzilla® Portable Air Compressors, 2 HP											
CB20100F	2 HP	10 Gal.	5.8 CFM	125 PSI	1740 RPM	2-Cyl	ELECTRIC	14 AMPS @ 115V	●	●	●
CB20200F	2 HP	20 Gal.	5.8 CFM	125 PSI	1740 RPM	2-Cyl	ELECTRIC	14 AMPS @ 115V	●	●	●

FLEXIBLE HYBRID POLYMER

Flexzilla® hoses have a durable, abrasion-resistant outer cover.

WON'T KINK UNDER PRESSURE

Lightweight and easy to handle, Flexzilla hoses lay flat, have no memory and won't kink under pressure.

AIR HOSES

EXTREME ALL-WEATHER FLEXIBILITY

Flexzilla hoses offer extreme all-weather flexibility, even in subzero temperatures (-40° to 140°F).



Air Hose Assemblies



Flexzilla® is a revolutionary hose featuring a Flexible Hybrid Polymer material that redefines flexibility. This engineered polymer-blend material permits use in environments where general purpose PVC and rubber hose may become too stiff. Flexzilla hose characteristics offer zero memory allowing it to lay flat. It won't work against you during operation and coils easily after use. Flexzilla offers extreme all-weather flexibility, even in subzero conditions, and is ideal in both hot and cold environments where tight radius bends are needed.



HFZ3850YW2

Part No.	Hose I.D.	Hose Length	Fittings	Retail Packaging	Made in USA
HFZ1425YW2	1/4 in.	25 ft.	1/4 in. MNPT	●	●
HFZ1450YW2	1/4 in.	50 ft.	1/4 in. MNPT	●	●
HFZ14100YW2	1/4 in.	100 ft.	1/4 in. MNPT	●	●
HFZ14100YW2-3X	1/4 in.	100 ft.	1/4 in. MNPT	●	●
HFZ3825YW2	3/8 in.	25 ft.	1/4 in. MNPT	●	●
HFZ3825YW2-5X	3/8 in.	25 ft.	1/4 in. MNPT	●	●
HFZ3835YW2	3/8 in.	35 ft.	1/4 in. MNPT	●	●
HFZ3850YW2	3/8 in.	50 ft.	1/4 in. MNPT	●	●
HFZ3850YW2-3X	3/8 in.	50 ft.	1/4 in. MNPT	●	●
HFZ3850YW2-10X	3/8 in.	50 ft.	1/4 in. MNPT	●	●
HFZ3850YW3	3/8 in.	50 ft.	3/8 in. MNPT	—	●
HFZ38100YW2	3/8 in.	100 ft.	1/4 in. MNPT	●	●
HFZ1225YW3	1/2 in.	25 ft.	3/8 in. MNPT	●	—
HFZ1250YW3	1/2 in.	50 ft.	3/8 in. MNPT	●	—
HFZ1250YW4	1/2 in.	50 ft.	1/2 in. MNPT	—	—
HFZ12100YW3	1/2 in.	100 ft.	3/8 in. MNPT	●	—
HFZ12100YW4	1/2 in.	100 ft.	1/2 in. MNPT	—	—

Part nos. with a -3X, -5X or 10X suffix include 3, 5 or 10 hose assemblies respectively in a retail merchandiser display

FEATURES:

- Extreme all-weather flexibility, even in subzero temperatures (-40° to 140°F)
- Won't kink under pressure
- Lightweight and easy to handle
- Lays flat - no memory
- Durable and abrasion-resistant outer cover
- Anodized aircraft aluminum ends
- Max. working pressure at 70°F: 300 psi
- Includes bend restrictors to reduce wear and tear, prolonging the life of the hose

MADE IN USA
(3/8 and 1/4 in. hose assemblies only)



HFZ3850YW2



HFZ3850YW2-3X

Air Hose Kits – Include Hose, Coupler, and Plug



This convenient hose kit features the revolutionary Flexzilla® air hose paired with a Red Industrial (Type D) 1/4 in. body ColorConnex® coupler and plug set (one each). Combining Flexzilla's revolutionary design and the convenient color coding of ColorConnex, you get two great products in one. Plus, since thread sealer is already installed on the coupler and plug, you're ready to go as soon as you reach the jobsite.



HFZ3850YW2-D

KIT INCLUDES:

- Flexzilla Air Hose
- ColorConnex Red Industrial (Type D) Coupler and Plug
- Pre-Sealed Threads

ASSEMBLED IN USA
of US and global components



HFZ3850YW2-D

FEATURING:

ColorConnex®
TYPE D / INDUSTRIAL

Use color to:

- Match coupler & plug types
- Dedicate hose applications



Part No.	Hose I.D.	Hose Length	Fittings	Retail Packaging	Assembled in USA
HFZ1425YW2-D	1/4 in.	25 ft.	1/4 in. MNPT	●	●
HFZ1450YW2-D	1/4 in.	50 ft.	1/4 in. MNPT	●	●
HFZ14100YW2-D	1/4 in.	100 ft.	1/4 in. MNPT	●	●
HFZ3825YW2-D	3/8 in.	25 ft.	1/4 in. MNPT	●	●
HFZ3835YW2-D	3/8 in.	35 ft.	1/4 in. MNPT	●	●
HFZ3850YW2-D	3/8 in.	50 ft.	1/4 in. MNPT	●	●
HFZ38100YW2-D	3/8 in.	100 ft.	1/4 in. MNPT	●	●



Air Hose Kit – Includes Hose, Blow Gun and Accessories



11-Piece Air Compressor Kit

KIT INCLUDES:

- (1) Flexzilla Air Hose, 50 ft. x 3/8 in.
- (1) Blow Gun with safety tip
- (1) Ball Foot Chuck
- (1) Pencil Tire Pressure Gauge (10 to 100 psi)
- (1) Coupler, 1/4 in. FNPT
- (1) Coupler, 1/4 in. MNPT
- (2) Plugs, 1/4 in. FNPT
- (3) Plugs, 1/4 in. MNPT

ASSEMBLED IN USA
of US and global components



HFZCLB11D



HFZCLB11D

Part No.	Hose I.D.	Hose Length	Fittings	Retail Packaging	Assembled in USA
HFZCLB11D	3/8 in.	50 ft.	1/4 in. NPT	●	●
HFZCLB11D-3X	3/8 in.	50 ft.	1/4 in. NPT	●	●

Part no. with a -3X suffix include 3 hose assemblies in a retail merchandiser display

Whip Hose Assemblies



WHY USE A WHIP HOSE?

- Increased longevity of the main hose
- Reduces user fatigue by eliminating weight of coupler/plug
- Increases mobility in tight spaces
- Improves air tool ergonomics

ASSEMBLED IN USA
of US and global components



HFZ3806YW2B

Part No.	Hose I.D.	Hose Length	Fittings	Retail Packaging	Assembled in USA
HFZ1405YW2B	1/4 in.	5 ft.	1/4 in. MNPT Ball Swivel x 1/4 in. FNPT	–	●
HFZ3802YW2B	3/8 in.	2 ft.	1/4 in. MNPT Ball Swivel x 1/4 in. FNPT	●	●
HFZ3804YW2B	3/8 in.	4 ft.	1/4 in. MNPT Ball Swivel x 1/4 in. FNPT	●	●
HFZ3806YW2B	3/8 in.	6 ft.	1/4 in. MNPT Ball Swivel x 1/4 in. FNPT	●	●
HFZ1202YW3S	1/2 in.	2 ft.	3/8 in. MNPT Swivel x 3/8 in. MNPT	–	–
HFZ1204YW3S	1/2 in.	4 ft.	3/8 in. MNPT Swivel x 3/8 in. MNPT	–	–
HFZ1206YW3S	1/2 in.	6 ft.	3/8 in. MNPT Swivel x 3/8 in. MNPT	–	–
HFZ1208YW3S	1/2 in.	8 ft.	3/8 in. MNPT Swivel x 3/8 in. MNPT	–	–
HFZ1202YW4S	1/2 in.	2 ft.	1/2 in. MNPT Swivel x 1/2 in. MNPT	–	–
HFZ1204YW4S	1/2 in.	4 ft.	1/2 in. MNPT Swivel x 1/2 in. MNPT	–	–
HFZ1206YW4S	1/2 in.	6 ft.	1/2 in. MNPT Swivel x 1/2 in. MNPT	–	–

Polyurethane Recoil Hose

The Flexzilla® revolution continues with the Flexzilla polyurethane recoil air hose. Flexzilla recoil air hose exhibits extreme, all-weather flexibility and outperforms nylon hose. Plus, with the field repairable fittings, damaged hose can be repaired quickly, using tools commonly available on the jobsite.

FEATURES:

- Extreme all-weather flexibility (-40° to 165°F)
- Polyurethane outperforms nylon:
 - More flexible
 - Will not become brittle over time
 - Better recoil memory
- Working pressure at 70°F: 120 psi
- 1/4 in. MNPT reusable ends
- Safety factor: 3:1
- Tool end: 16 in. tail with swivel fitting
- Compressor end: 8 in. tail with rigid fitting
- Pre-applied thread sealer

Part No.	Hose I.D.	Hose Length	Fittings	Retail Packaging
LP1410AFZ	1/4 in.	10 ft.	1/4 in. MNPT	●
LP1415AFZ	1/4 in.	15 ft.	1/4 in. MNPT	●
LP1420AFZ	1/4 in.	20 ft.	1/4 in. MNPT	●
LP1425AFZ	1/4 in.	25 ft.	1/4 in. MNPT	●



LP1425AFZ

Hose Crimper

Hose Crimper		
Part No.	Die Bore Sizes	Retail Packaging
A5	5/8 in. 37/64 in. (For 3/8 in. Flexzilla Air Hose) 17/32 in. 7/16 in. (For 1/4 in. Flexzilla Air Hose) 11/16 in. (For 1/2 in. Flexzilla Air Hose)	-



A5

Flexzilla® Pro Air Hose



Flexzilla® Pro Air Hose is available in pre-assembled coils or in our Custom Hose Centers where the end user can fabricate a custom length hose for any application. The field repair and custom length hose process takes

3 EASY STEPS

✓ CUSTOM LENGTHS



1
CUT – Measure and cut desired length of hose at 90° angle.



2
INSTALL – Slide spiral fitting and nut onto hose. Push hose onto fitting until hose reaches threads.



3
TIGHTEN – Tighten fitting nut until snug. Slide bend restrictor up and snap onto nut.

✓ FIELD REPAIRABLE



1
CUT – Cut damaged portion of hose at 90° angle. Slide fitting nuts onto hose.



2
INSTALL – Slide hose onto fitting until hose reaches threads.



3
TIGHTEN – Tighten fitting nuts until snug.

Custom Hose Centers



The Flexzilla® Pro Custom Hose Centers allow you to provide your customers with custom length hose assemblies. Using Flexzilla Pro reusable ends, you can quickly and easily create custom length hose assemblies on site.

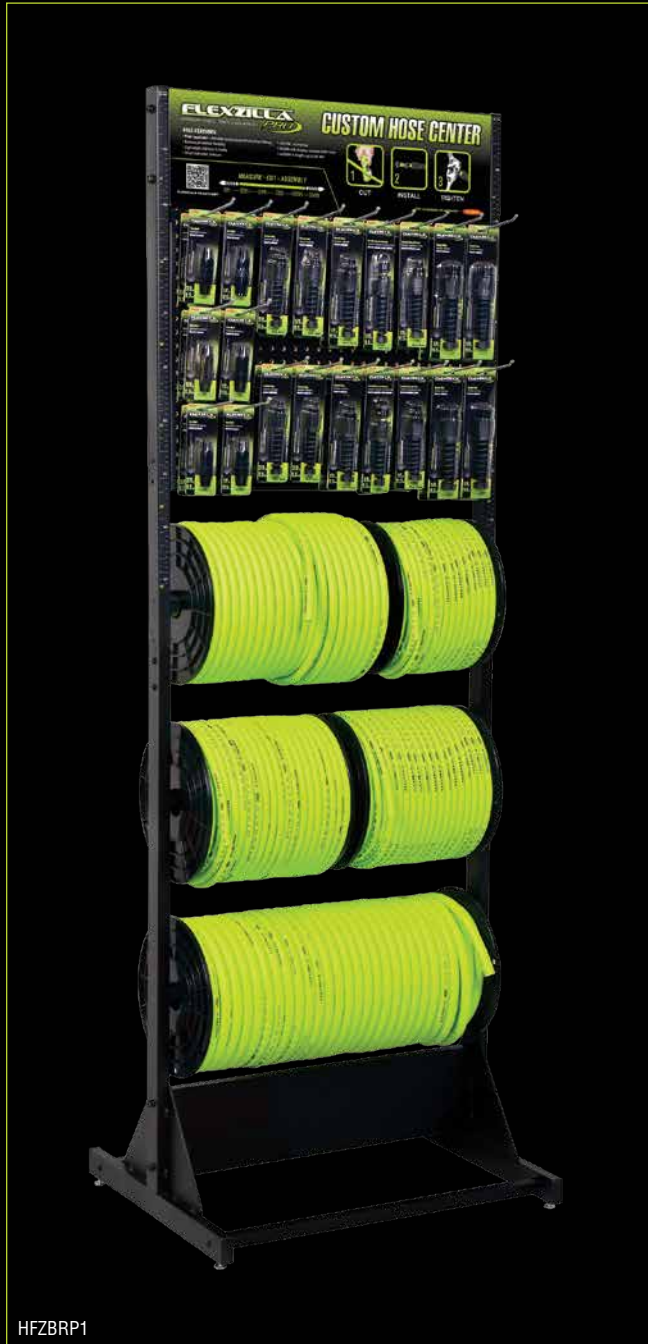

Custom Hose Centers (continued)



HFZBRP1 - Flexzilla® Pro Custom Hose Center

Part No.	Description	Rack Quantity
HFZ12250YW	Flexzilla® Pro Air Hose, 1/2 in. x 250 ft. Spool	1 ea.
HFZ14250YW	Flexzilla® Pro Air Hose, 1/4 in. x 250 ft. Spool	2 ea.
HFZ38250YW	Flexzilla® Pro Air Hose, 3/8 in. x 250 ft. Spool	2 ea.
HFZW58250YW	Flexzilla® Pro Water Hose, 5/8 in. x 250 ft. Spool	1 ea.
RP900250	Flexzilla® Pro Air Hose Reusable Fitting, 1/4 in.	10 ea.
RP900250BS	Flexzilla® Pro Air Hose Reusable Fitting with Ball Swivel, 1/4 in.	10 ea.
RP900375	Flexzilla® Pro Air Hose Reusable Fitting, 3/8 in.	10 ea.
RP900375BS	Flexzilla® Pro Air Hose Reusable Fitting with Ball Swivel, 3/8 in.	10 ea.
RP900500	Flexzilla® Pro Air Hose Reusable Fitting, 1/2 in.	10 ea.
RP900500S	Flexzilla® Pro Air Hose Reusable Fitting with Swivel, 1/2 in.	10 ea.
RP900625F	Flexzilla® Pro Water Hose Female Reusable Fitting, 5/8 in.	10 ea.
RP900625M	Flexzilla® Pro Water Hose Male Reusable Fitting, 5/8 in.	10 ea.
RP901250	Flexzilla® Pro Air Hose Reusable Splicer, 1/4 in.	10 ea.
RP901375	Flexzilla® Pro Air Hose Reusable Splicer, 3/8 in.	10 ea.
RP901500	Flexzilla® Pro Air Hose Reusable Splicer, 1/2 in.	10 ea.
HR-05	Custom Hose Center (Freestanding Rack)	1 ea.

Parts also sold separately in standard pack quantities

HFZBRP3 - Flexzilla® Pro Custom Hose Center

Part No.	Description	Rack Quantity
HFZ12250YW	Flexzilla® Pro Air Hose, 1/2 in. x 250 ft. Spool	1 ea.
HFZ38250YW	Flexzilla® Pro Air Hose, 3/8 in. x 250 ft. Spool	4 ea.
HFZW58250YW	Flexzilla® Pro Water Hose, 5/8 in. x 250 ft. Spool	2 ea.
RP900375	Flexzilla® Pro Air Hose Reusable Fitting, 3/8 in.	20 ea.
RP900375BS	Flexzilla® Pro Air Hose Reusable Fitting with Ball Swivel, 3/8 in.	20 ea.
RP900500	Flexzilla® Pro Air Hose Reusable Fitting, 1/2 in.	10 ea.
RP900500S	Flexzilla® Pro Air Hose Reusable Fitting with Swivel, 1/2 in.	10 ea.
RP900625F	Flexzilla® Pro Water Hose Female Reusable Fitting, 5/8 in.	10 ea.
RP900625M	Flexzilla® Pro Water Hose Male Reusable Fitting, 5/8 in.	10 ea.
RP901375	Flexzilla® Pro Air Hose Reusable Splicer, 3/8 in.	20 ea.
RP901500	Flexzilla® Pro Air Hose Reusable Splicer, 1/2 in.	10 ea.
HR-05	Custom Hose Center (Freestanding Rack)	1 ea.

Parts also sold separately in standard pack quantities

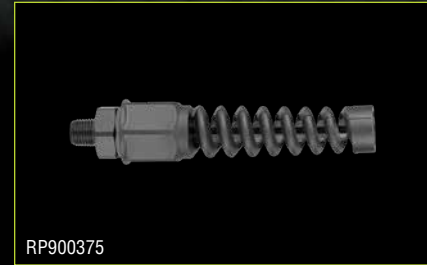

RP900375



RP900375BS

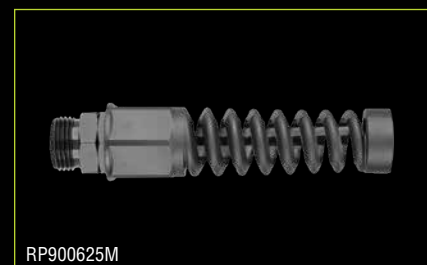

RP900625M



RP901250



HFZ38250YW



HFZ12250YW

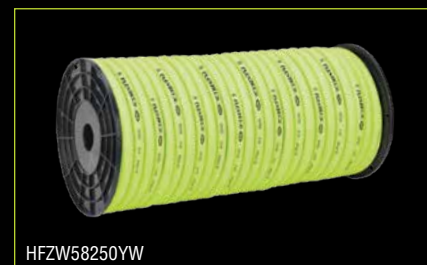

HFZW58250YW

Reusable Fittings and Splicers – Air and Water Hose



Flexzilla® Pro Reusable Fittings and Splicers allow you to quickly repair Flexzilla hose on the jobsite, or create a custom length hose in just three easy steps.

Splicers Include:

- Reusable MNPT anodized aircraft aluminum fitting for Flexzilla and Flexzilla Pro Air Hose



Part No.	Description	Application	Fitting	Barb Size	Retail Packaging
RP900250	Reusable Fitting	Air	1/4 in. MNPT	1/4 in.	●
RP900250BS	Reusable Ball Swivel Fitting	Air	1/4 in. MNPT	1/4 in.	●
RP900250S	Reusable Swivel Fitting	Air	1/4 in. MNPT	1/4 in.	●
RP900375	Reusable Fitting	Air	1/4 in. MNPT	3/8 in.	●
RP900375BS	Reusable Ball Swivel Fitting	Air	1/4 in. MNPT	3/8 in.	●
RP900375S	Reusable Swivel Fitting	Air	1/4 in. MNPT	3/8 in.	●
RP900500	Reusable Fitting	Air	3/8 in. MNPT	1/2 in.	●
RP900500S	Reusable Ball Swivel Fitting	Air	3/8 in. MNPT	1/2 in.	●
RP901250	Hose Splicer	Air	–	1/4 in.	●
RP901375	Hose Splicer	Air	–	3/8 in.	●
RP901500	Hose Splicer	Air	–	1/2 in.	●
RP900625F	Reusable Fitting	Water	3/4 in. Female GHT	5/8 in.	●
RP900625M	Reusable Fitting	Water	3/4 in. Male GHT	5/8 in.	●

Bulk Air and Water Hose



Flexzilla® Pro bulk hose spools allow you to create custom length hose.



Part No.	Application	Hose I.D.	Spool Length	Hose Fittings	Max. Working Pressure	Retail Packaging
HFZ14250YW	Air	1/4 in.	250 ft.	Sold separately	300 psi	–
HFZ38250YW	Air	3/8 in.	250 ft.	Sold separately	300 psi	–
HFZ12250YW	Air	1/2 in.	250 ft.	Sold separately	300 psi	–
HFZW58250YW	Water	5/8 in.	250 ft.	Sold separately	150 psi	–

Air Hose Assemblies



Flexzilla® Pro Field Repairable Air Hose features extreme all-weather flexibility, rugged durability and won't kink under pressure. Its unique Flexible Hybrid Polymer material redefines flexibility. With reusable anodized aircraft aluminum fittings, the Flexzilla Pro Air Hose can be repaired on the jobsite in a few simple steps.



HFZP3850YW2

FEATURES:

- Field Repairable – Reusable anodized aircraft aluminum fittings
- Extreme all-weather flexibility, even in subzero temperatures (-40° to 140°F)
- Won't kink under pressure
- Lightweight and easy to handle
- Lays flat - no memory
- Durable and abrasion-resistant outer cover
- Max. working pressure at 70°F: 300 psi
- Flexzilla Pro Reusable Fittings include bend reinforcement to reduce wear and tear, prolonging the life of the hose



HFZP38100YW2

Part No.	Hose I.D.	Hose Length	Fittings	Retail Packaging
HFZP1425YW2	1/4 in.	25 ft.	1/4 in. MNPT	●
HFZP1450YW2	1/4 in.	50 ft.	1/4 in. MNPT	●
HFZP14100YW2	1/4 in.	100 ft.	1/4 in. MNPT	●
HFZP3825YW2	3/8 in.	25 ft.	1/4 in. MNPT	●
HFZP3835YW2	3/8 in.	35 ft.	1/4 in. MNPT	●
HFZP3850YW2	3/8 in.	50 ft.	1/4 in. MNPT	●
HFZP38100YW2	3/8 in.	100 ft.	1/4 in. MNPT	●

Air Hose Kits – Include Hose, Coupler and Plug



This convenient hose kit features the revolutionary Flexzilla® Pro Flexible Hybrid Polymer air hose paired with a Red Industrial (Type D) ColorConnex® Coupler and Plug Set (one each). Combining Flexzilla's revolutionary design and the convenient color coding of ColorConnex, you get two great products in one. Plus, since the thread sealer is already installed on the coupler and plug, you're ready to go as soon as you reach the jobsite.

KIT INCLUDES:

- Flexzilla Pro Air Hose
- ColorConnex Red Industrial (Type D) Coupler and Plug
- Pre-sealed Threads

Part No.	Hose I.D.	Hose Length	Fittings	Retail Packaging
HFZP1425YW2-D	1/4 in.	25 ft.	1/4 in. MNPT	●
HFZP1450YW2-D	1/4 in.	50 ft.	1/4 in. MNPT	●
HFZP14100YW2-D	1/4 in.	100 ft.	1/4 in. MNPT	●
HFZP3825YW2-D	3/8 in.	25 ft.	1/4 in. MNPT	●
HFZP3850YW2-D	3/8 in.	50 ft.	1/4 in. MNPT	●
HFZP38100YW2-D	3/8 in.	100 ft.	1/4 in. MNPT	●

FEATURING: **ColorConnex®** TYPE D / INDUSTRIAL **Use color to:**

- Match coupler & plug types
- Dedicate hose applications



Custom Length Whip Hose with High Flow Ball Swivel



WHY USE A WHIP HOSE?

- Increased longevity of the main hose
- Reduces user fatigue by eliminating weight of coupler/plug
- Increases mobility in tight spaces
- Improves air tool ergonomics



Part No.	Hose I.D.	Hose Length	Fittings	Retail Packaging
HFZP3806YW2B	3/8 in.	6 ft.	1/4 in. MNPT High Flow Ball Swivel and Reusable Fitting (RP900375)	●

AIR HOSE REELS



LEVELWIND™ TECHNOLOGY

Automatically layers the hose back and forth across the reel.

LATCHING MODE SWITCH

Latch hose every three feet for extended use or switch to free run for immediate, automatic rewinding.

Retractable Air Hose Reels with Levelwind™ Technology



Featuring Levelwind™ – Flexzilla’s unique winding system that automatically layers hose back and forth across the reel ensuring that the hose is coiled smoothly, easily...every time – and includes Flexzilla® air hose and lead-in hose.



Levelwind™ Technology
Layers the hose evenly, easily...every time!



L8305FZ

FEATURES:

- **Latching Mode Switch** - Choose from latching hose every 3 ft. for extended use or switch to free run for immediate automatic rewinding
- **Seven Position Locking Bracket** - These reels can swivel freely on a mounting bracket up to 135° or can be locked into place using the locking brace. Up to seven different locking angles can be utilized (L8300-W)
- **Adjustable Hose Stopper** - Increase or decrease the length of the hose that remains when hose is fully retracted
- **Extra Large Swivel** - A 3/4 in. swivel reduces flow restrictions and allows for maximum flow
- **Freestanding Base** - Portable - Use freestanding or mounted on wall or ceiling. Flat base allows reel to rest on the ground
- **Built-In Handle** - For carrying ease
- **Durable Construction** - Made from durable UV stabilized polypropylene
- **Hose Material** - Flexible Hybrid Polymer
- **Lead-in Hose Included** - 5 ft.

ASSEMBLED IN USA
of US and global components

Retractable Air Hose Reels with Levelwind™ Technology

Part No.	Hose I.D.	Hose Length	Working Pressure @ 70°F	Temperature Range (F°)	Lead-in Hose Connection	Reel Inlet	Hose Outlet	Weight	Retail Packaging	Assembled in USA
L8305FZ	3/8 in.	50 ft.	300 psi	-40° to 140°	3/4 in. Female GHT x 1/4 in. MNPT	3/4 in. – 1 1/2 Male GHT	1/4 in. MNPT	25 lbs.	●	●
L8306FZ	3/8 in.	75 ft.	300 psi	-40° to 140°	3/4 in. Female GHT x 1/4 in. MNPT	3/4 in. – 1 1/2 Male GHT	1/4 in. MNPT	30 lbs.	●	●
L8335FZ	1/2 in.	50 ft.	300 psi	-40° to 140°	3/4 in. Female GHT x 3/8 in. MNPT	3/4 in. – 1 1/2 Male GHT	3/8 in. MNPT	29 lbs.	●	●

Mounting Brackets

L8300-B FEATURES:

- Includes a seven position locking bracket
- Reel can swivel freely on mounting bracket up to 360° or can be locked into place using the locking brace
- Mounting options: high wall or bench

L8300-W FEATURES:

- Includes a seven position locking bracket
- Reel can swivel freely on mounting bracket up to 135° or can be locked into place using the locking brace
- Mounting options: wall or overhead ceiling



L8300-B

L8300-W

NEW Retractable Air Hose Reel



The Flexzilla® Pro Retractable Air Hose Reel comes pre-loaded with 50 feet of 3/8 in. Made in USA Flexzilla Air Hose. The reel features a self-leveling system which layers the hose evenly when rewinding. The auto retract/latch hose mechanism automatically locks the hose in place in 17 in. intervals. The swivel mounting bracket allows the reel to pivot in the direction of your work. The impact resistant reel housing protects and stores the air hose when not in use. This retractable reel is ideal for commercial and industrial use.



FEATURES:

- **Self-leveling System** - Winds the hose evenly
- **Auto Retract/Latch Hose Mechanism** - Reel automatically locks hose in place at 17 in. intervals
- **Adjustable Hose Stopper** - Increase or decrease the length of the hose that remains when hose is fully retracted
- **Swivel Mounting Bracket** - Pivots in the direction of your work, reel can be mounted to wall or ceiling
- **Impact Resistant Housing**
- **Lead-in Hose Included** - 5 ft. x 1/4 in. MNPT

ASSEMBLED IN USA
of US and global components

L8251FZP

HOSE I.D.	WORKING PRESSURE
3/8 IN.	150 PSI

Retractable Air Hose Reel

Part No.	Hose I.D.	Hose Length	Working Pressure @ 70°F	Temperature Range (F°)	Lead-in Hose Connection	Hose Outlet	Weight	Retail Packaging
L8251FZP	3/8 in.	50 ft.	150 psi	-40° to 140°	-40° to 140°	1/4 in. MNPT	16 lbs.	●

Retractable Air Hose Reels



These economical, retractable air hose reels are ideal for the home shop.



L8232FZ

HOSE I.D.	WORKING PRESSURE
3/8 IN.	150 PSI

L8232FZ FEATURES:

- **Automatic Leveling System** - Layers the hose evenly when rewinding
- **Multipoint Latch Mechanism** - Reel will automatically lock hose in place at any length wherever you stop
- **Impact Resistant Housing**
- **Speed Control Device** - Provides consistent and safe speed when retracting the hose
- **Adjustable Hose Stopper** - Increase or decrease the length of the hose that remains when hose is fully retracted
- **Swivel Mounting Bracket** - Pivots in the direction of your work, reel can be mounted to wall or ceiling
- **Lead-in Hose Included** - 3 ft. x 1/4 in. MNPT



L8250FZ

HOSE I.D.	WORKING PRESSURE
3/8 IN.	150 PSI

L8250FZ FEATURES:

- **Auto Retract/Latch Hose Mechanism** - Simplifies every job by keeping excess hose out of the work space
- **Positive Latching Mechanism** - Locks hose automatically in 18 in. intervals
- **Durable Construction** - Made from durable UV stabilized polypropylene
- **Adjustable Hose Stopper** - Increase or decrease the length of the hose that remains when hose is fully retracted
- **Swivel Mounting Bracket** - Pivots in the direction of your work, reel can be mounted to wall or ceiling
- **Lead-in Hose Included** - 3 ft. x 1/4 in. MNPT

Retractable Air Hose Reels

Part No.	Hose I.D.	Hose Length	Working Pressure @ 70°F	Temperature Range (F°)	Lead-in Hose Connection	Hose Outlet	Weight	Retail Packaging
L8232FZ	3/8 in.	30 ft.	150 psi	-40° to 140°	1/4 in. MNPT	1/4 in. MNPT	13 lbs.	●
L8250FZ	3/8 in.	50 ft.	150 psi	-40° to 140°	1/4 in. MNPT	1/4 in. MNPT	17 lbs.	●

Retractable Air Hose Reels – Single Axle Arm Support



These retractable, open face hose reels are ideal for indoor shop, mobile and industrial applications.



L8611FZ

HOSE I.D.	WORKING PRESSURE
3/8 IN.	300 PSI

FEATURES:

- **Multi-Position Guide Arm** - Allows mounting on wall, tank or overhead
- **Durable Heavy-Duty Steel Construction** - Provides strength and stability to the reel and bracket
- **Corrosion-Resistant Powder Coating** - Provides extra measure of protection against the elements
- **Four-Way Direction Rollers** - Allow the hose to be easily pulled from the reel
- **Self-Locking Fasteners** - Stay tight even in mobile installations
- **Narrow Size** - Ideal for easy placement and storage
- **Multi-Position Release Ratchet** - Allows appropriate amount of hose to be extended for each jobsite
- **Metal Latching Pawl** - Makes an audible clicking sound allowing the latching zone to be locked quickly and easily
- **Fully-Enclosed Spring Motor** - Packed with grease for extended life
- **Hose Material** - Flexible Hybrid Polymer
- **Lead-in Hose Included** - 5 ft.

ASSEMBLED IN USA
of US and global components

Retractable Air Hose Reels – Single Axle Arm Support

Part No.	Hose I.D.	Hose Length	Working Pressure @ 70°F	Temperature Range (F°)	Lead-in Hose Connection	Reel Inlet	Hose Outlet	Weight	Retail Packaging	Assembled in USA
L8603FZ	3/8 in.	25 ft.	300 psi	-40° to 140°	1/4 in. MNPT x 1/4 in. MNPT	1/4 in. FNPT	1/4 in. MNPT	25 lbs.	-	●
L8611FZ	3/8 in.	50 ft.	300 psi	-40° to 140°	3/8 in. MNPT Swivel x 1/4 in. MNPT	3/8 in. FNPT Swivel	1/4 in. MNPT*	40 lbs.	●	-

*1/4 in. MNPT x 3/8 in. bushing included

Retractable Air Hose Reels – Dual Axle Arm Support



Featuring dual axle arm support, these retractable open face hose reels can withstand constant vibration making them ideal for mobile installations.



L8711FZ

HOSE I.D.	WORKING PRESSURE
3/8 IN.	300 PSI



L8741FZ

HOSE I.D.	WORKING PRESSURE
1/2 IN.	300 PSI

FEATURES:

- **Multi-Position Release Ratchet** - Allows appropriate amount of hose to be extended for each jobsite
- **Durable Heavy-Duty Steel Construction** - Provides strength and stability to the reel
- **Corrosion-Resistant Powder Coating** - Provides extra measure of protection against the elements
- **Four-Way Direction Rollers** - Allow the hose to be easily pulled from the reel
- **Self-Locking Fasteners** - Stay tight even in mobile installations
- **Narrow Size** - Ideal for easy placement and storage
- **Multi-Position Guide Arm** - Allows mounting on wall, truck, tank or overhead
- **Galvanized Dual Support Arms and Bases** - Resist rust and corrosion
- **Dual Axle Arm Support** - Can withstand the constant vibration of mobile installations
- **Hose Material** - Flexible Hybrid Polymer
- **Lead-in Hose Included** - 5 ft.

ASSEMBLED IN USA
of US and global components

Retractable Air Hose Reels – Dual Axle Arm Support

Part No.	Hose I.D.	Hose Length	Working Pressure @ 70°F	Temperature Range (F°)	Lead-in Hose Connection	Reel Inlet	Hose Outlet	Weight	Retail Packaging	Assembled in USA
L8711FZ	3/8 in.	50 ft.	300 psi	-40° to 140°	3/8 in. MNPT Swivel x 1/4 in. MNPT	3/8 in. MNPT Swivel	3/8 in. MNPT	39 lbs.	-	●
L8741FZ	1/2 in.	50 ft.	300 psi	-40° to 140°	3/8 in. MNPT x 3/8 in. MNPT Swivel	3/8 in. MNPT	3/8 in. MNPT	44 lbs.	-	●

Retractable Air Hose Reels – Single Arm, Open Face



Built with quality and durability in mind, these reels incorporate heavy gauge steel and corrosion-resistant components to withstand the harsh conditions in the workplace.



L8011FZ



L8041FZ

HOSE I.D.	WORKING PRESSURE
3/8 IN.	300 PSI

HOSE I.D.	WORKING PRESSURE
1/2 IN.	300 PSI

FEATURES:

- **Multi-Position Release Ratchet** - Allows appropriate amount of hose to be extended for each jobsite
- **Durable Heavy-Duty Steel Construction** - Provides strength and stability to the reel
- **Corrosion-Resistant Powder Coating** - Provides extra measure of protection against the elements
- **Self-Locking Fasteners** - Stay tight even in mobile installations

- **Narrow Size** - Ideal for easy placement and storage
- **Multi-Position Guide Arm** - Allows mounting on wall, tank, overhead, bench, or vehicle
- **Hose Material** - Flexible Hybrid Polymer
- **Lead-in Hose Included** - 5 ft.

ASSEMBLED IN USA
of US and global components

Retractable Air Hose Reels – Single Arm, Open Face

Part No.	Hose I.D.	Hose Length	Working Pressure @ 70°F	Temperature Range (F°)	Lead-in Hose Connection	Reel Inlet	Hose Outlet	Weight	Retail Packaging	Assembled in USA
L8011FZ	3/8 in.	50 ft.	300 psi	-40° to 140°	3/8 in. MNPT Swivel x 3/8 in. MNPT	3/8 in. MNPT Swivel	3/8 in. MNPT	32 lbs.	-	●
L8041FZ	1/2 in.	50 ft.	300 psi	-40° to 140°	1/2 in. MNPT Swivel x 1/2 in. MNPT	1/2 in. MNPT Swivel	1/2 in. MNPT	33 lbs.	-	●

Manual Air Hose Reels



These manual open face hose reels are ideal for indoor shop, mobile and industrial applications.



L8550FZ

FEATURES:

- **Swivel Handle** - Pivots in hand for winding ease
- **Mounting Bracket** - Mount reel to wall, workbench or vehicle
- **Swivel** - Heavy-duty 1/4 in. brass
- **Baked Enamel Finish** - Provides a smooth and durable finish
- **Bend Restrictor** - Prolongs the life of the air hose
- **Hose Material** - Flexible Hybrid Polymer
- **Lead-in Hose Included** - 5 ft.

ASSEMBLED IN USA
of US and global components

HOSE I.D.	WORKING PRESSURE
3/8 IN.	300 PSI

Manual Air Hose Reels

Part No.	Hose I.D.	Hose Length	Working Pressure @ 70°F	Temperature Range (F°)	Lead-in Hose Connection	Reel Inlet	Hose Outlet	Weight	Retail Packaging	Assembled in USA
L8550FZ	3/8 in.	50 ft.	300 psi	-40° to 140°	1/4 in. MNPT x 1/4 in. MNPT	1/4 in. MNPT	1/4 in. MNPT	15 lbs.	-	●
L8560FZ	3/8 in.	100 ft.	300 psi	-40° to 140°	1/4 in. MNPT x 1/4 in. MNPT	1/4 in. MNPT	1/4 in. MNPT	22 lbs.	-	●

Manual Air Hose Reels – Fixed, Heavy Duty



These manual heavy-duty drum reels are compact and ideal for indoor shop and industrial applications.



L8650FZ

HOSE I.D.	WORKING PRESSURE	SUPPORT
3/8 IN.	300 PSI	SINGLE



L8652FZ

HOSE I.D.	WORKING PRESSURE	SUPPORT
3/8 IN.	300 PSI	DUAL

FEATURES:

- **Heavy-Duty Drum** - Heavy-duty steel reinforced drum.
- **Powder Coat Finish** - Provides a smooth and durable finish
- **Inlet Swivel** - Heavy-duty 1/4 in. brass
- **Tapered Side Walls** - Store more hose in less space
- **Swivel Handle** - Pivots in hand for winding ease
- **Mounting Bracket** - Mount reel to wall, workbench, or vehicle
- **Bend Restrictor** - Prolongs the life of the air hose

- **Dual Support** - Provides extra stability for the big jobs (L8652FZ only)
- **Spring Tension Brake** - Keeps hose from unwinding unintentionally (L8652FZ only)
- **Brake** - Keeps hose from unwinding unintentionally (L8650FZ only)
- **Hose Material** - Flexible Hybrid Polymer
- **Lead-in Hose Included** - 5 ft.

ASSEMBLED IN USA
of US and global components

Manual Air Hose Reels – Fixed, Heavy Duty

Part No.	Hose I.D.	Hose Length	Working Pressure @ 70°F	Temperature Range (F°)	Lead-in Hose Connection	Reel Inlet	Hose Outlet	Weight	Retail Packaging	Assembled in USA
L8650FZ	3/8 in.	50 ft.	300 psi	-40° to 140°	1/4 in. MNPT x 1/4 in. MNPT	1/4 in. MNPT	1/4 in. MNPT	16 lbs.	-	●
L8652FZ	3/8 in.	100 ft.	300 psi	-40° to 140°	1/4 in. MNPT x 1/4 in. MNPT	1/4 in. MNPT	1/4 in. MNPT	30 lbs.	●	●

Manual Air Hose Reels – Portable



Designed for portability, these reels are useful just about anywhere on the jobsite. Use an air manifold with the supply hose to service multiple air tools (air manifold is sold separately). The hose layering guide spools hose back onto the reel eliminating tangles; cleanup is faster and easier.



L8651FZ

HOSE I.D.	WORKING PRESSURE
3/8 IN.	300 PSI



L8654FZ

HOSE I.D.	WORKING PRESSURE
1/4 IN.	300 PSI

FEATURES:

- **Hose Layering Guide** - Manually operated guide smoothly winds hose without tangles
- **Spring Tension Brake** - Keeps hose from unwinding unintentionally
- **Carrying Handle** - For complete portability
- **Support Legs** - Attach support legs for placing reel on ground. Predrilled holes can be used for staking reel to the ground
- **Mounting Bracket** - Reel can be mounted on truck, wall or bench
- **Swivel Handle** - Swivels in hand for winding ease. Folds in for transporting
- **Hose Material** - Flexible Hybrid Polymer
- **Lead-in Hose Included** - 5 ft.

ASSEMBLED IN USA
of US and global components

Manual Air Hose Reels – Portable

Part No.	Hose I.D.	Hose Length	Working Pressure @ 70°F	Temperature Range (F°)	Lead-in Hose Connection	Reel Inlet	Hose Outlet	Weight	Retail Packaging	Assembled in USA
L8651FZ	3/8 in.	50 ft.	300 psi	-40° to 140°	1/4 in. MNPT x 1/4 in. MNPT	1/4 in. MNPT	1/4 in. MNPT	21 lbs.	●	●
L8654FZ	1/4 in.	100 ft.	300 psi	-40° to 140°	1/4 in. MNPT x 1/4 in. MNPT	1/4 in. MNPT	1/4 in. MNPT	21 lbs.	-	●

Lead-In Hoses



Flexzilla hose reels come equipped with a lead-in hose as standard equipment. Details regarding the lead-in hose that comes with each reel model are listed below. If for some reason you need to replace your lead-in hose, please refer to the part number that corresponds to your model of reel.

MADE IN USA



Part No.	Lead-in Hose For Part Nos.	Hose I.D.	Hose Length	Fittings	Hose Material	Working Pressure @ 70°F	Temperature Range (F°)	Retail Packaging	Made in USA	Assembled in USA
L8011FZLI	L8011FZ	3/8 in.	5 ft.	3/8 in. MNPT Swivel x 3/8 in. MNPT	Flexible Hybrid Polymer	300 psi	-40° to 140°	–	●	–
L8250FZLI	L8250FZ	3/8 in.	3 ft.	1/4 in. MNPT	Flexible Hybrid Polymer	150 psi	-40° to 140°	–	–	●
L8251FZPLI	L8251FZP	3/8 in.	5 ft.	1/4 in. MNPT	Flexible Hybrid Polymer	150 psi	-40° to 140°	–	–	●
L8305FZLI	L8305FZ L8306FZ	3/8 in.	5 ft.	3/4 in. Female GHT x 1/4 in. MNPT	Flexible Hybrid Polymer	300 psi	-40° to 140°	–	–	–
L8335FZLI	L8335FZ	1/2 in.	5 ft.	3/4 in. Female GHT x 3/8 in. MNPT	Flexible Hybrid Polymer	300 psi	-40° to 140°	–	–	–
L8611FZLI	L8611FZ L8711FZ	3/8 in.	5 ft.	3/8 in. MNPT Swivel x 1/4 in. MNPT	Flexible Hybrid Polymer	300 psi	-40° to 140°	–	●	–
L8651FZLI	L8550FZ L8560FZ L8603FZ L8650FZ L8651FZ L8652FZ	3/8 in.	5 ft.	1/4 in. MNPT x 1/4 in. MNPT	Flexible Hybrid Polymer	300 psi	-40° to 140°	–	●	–
L8654FZLI	L8654FZ	1/4 in.	5 ft.	1/4 in. MNPT x 1/4 in. MNPT	Flexible Hybrid Polymer	300 psi	-40° to 140°	–	–	●

360° ROTATION

Ball swivel rotates
360° at a 30° angle.

HIGH FLOW

High flow couplers and plugs
allow twice the amount of
airflow to your tool.

AIR LINE ACCESSORIES

High Flow Couplers and Plugs



PRO

Flexzilla® Pro High Flow couplers and plugs allow Twice The Flow to your air tools compared to standard interchanges. Connect Flexzilla High Flow fittings from your tool all the way to the compressor. This ensures the best performance your air system can provide. For maximum efficiency, use Flexzilla Pro High Flow.



Don't Starve Your Air Tool!

- Push-To-Connect System
- Maximum Torque
- Maximum RPM
- Ideal for spray guns and impact tools or any high output tool

Flexzilla Pro High Flow Ball Swivel

brings ergonomic ease to any tool attached to it. Save your wrist and improve your ability to get into hard-to-reach places.

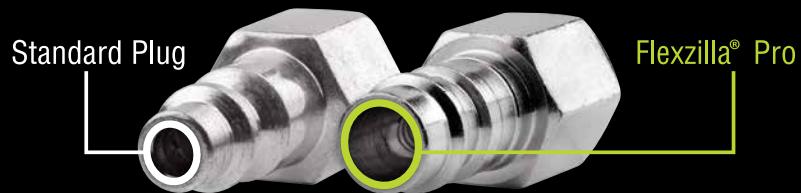

Larger internal diameter = Twice The Flow!

When compared to standard interchanges.

Ball swivel rotates 360° at a 30° angle.



High Flow Couplers and Plugs



PRO

Couplers



A53416FZ-X



A53426FZ-X



A53616FZ-X

Part No.	Type	Interchange	Connection Size	Body Size	Max. Pressure	Material	Retail Packaging
High Flow Couplers							
A53416FZ	Z	High Flow	1/4 in. FNPT	1/4 in.	300 psi	Steel/Aluminum*	●
A53416FZ-X	Z	High Flow	1/4 in. FNPT	1/4 in.	300 psi	Steel/Aluminum*	-
A53426FZ	Z	High Flow	1/4 in. MNPT	1/4 in.	300 psi	Steel/Aluminum*	●
A53426FZ-X	Z	High Flow	1/4 in. MNPT	1/4 in.	300 psi	Steel/Aluminum*	-
A53616FZ	Z	High Flow	3/8 in. FNPT	1/4 in.	300 psi	Steel/Aluminum*	●
A53616FZ-X	Z	High Flow	3/8 in. FNPT	1/4 in.	300 psi	Steel/Aluminum*	-
A53626FZ	Z	High Flow	3/8 in. MNPT	1/4 in.	300 psi	Steel/Aluminum*	●
A53626FZ-X	Z	High Flow	3/8 in. MNPT	1/4 in.	300 psi	Steel/Aluminum*	-

*Nickel Plated Steel with Anodized Aluminum Sleeve

-X = Product offered in bulk, individually bagged product

Plugs



PRO

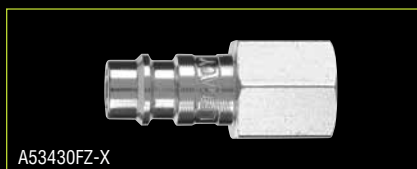

A53430FZ-X



A53440FZ-X



A53440FZBS-X

Part No.	Type	Interchange	Connection Size	Body Size	Max. Pressure	Material	Retail Packaging
High Flow Plugs							
A53430FZ-X	Z	High Flow	1/4 in. FNPT	1/4 in.	300 psi	Nickel Plated Steel	-
A53440FZ-X	Z	High Flow	1/4 in. MNPT	1/4 in.	300 psi	Nickel Plated Steel	-
A53630FZ-X	Z	High Flow	3/8 in. FNPT	1/4 in.	300 psi	Nickel Plated Steel	-
A53640FZ-X	Z	High Flow	3/8 in. MNPT	1/4 in.	300 psi	Nickel Plated Steel	-
A53440FZBS	Z	High Flow	1/4 in. MNPT	1/4 in.	300 psi	Nickel Plated Steel	●
A53440FZBS-X	Z	High Flow	1/4 in. MNPT	1/4 in.	300 psi	Nickel Plated Steel	-
High Flow Plugs – 2-Pc.							
A53430FZ-2PK	Z	High Flow	1/4 in. FNPT	1/4 in.	300 psi	Nickel Plated Steel	●
A53440FZ-2PK	Z	High Flow	1/4 in. MNPT	1/4 in.	300 psi	Nickel Plated Steel	●
A53630FZ-2PK	Z	High Flow	3/8 in. FNPT	1/4 in.	300 psi	Nickel Plated Steel	●
A53640FZ-2PK	Z	High Flow	3/8 in. MNPT	1/4 in.	300 psi	Nickel Plated Steel	●

-X = Product offered in bulk, individually bagged product

High Flow Coupler and Plug Kits



PRO



A53452FZ



A53457FZ



A53657FZ



A53458FZ



A53458FZ Retail Packaging



A86666FZ

Part No.	Type	Interchange	Connection Size	Body Size	Max. Pressure	Material	Contents	Retail Packaging
3-Pc. Coupler and Plug Kit								
A53452FZ	Z	High Flow	1/4 in. NPT	1/4 in.	300 psi	Steel/Aluminum*	(1) FNPT Coupler, (1) FNPT Plug and (1) MNPT Plug	●
7-Pc. Coupler and Plug Kits								
A53457FZ	Z	High Flow	1/4 in. NPT	1/4 in.	300 psi	Steel/Aluminum*	(1) FNPT Coupler, (1) MNPT Coupler, (2) FNPT Plug and (3) MNPT Plug	●
A53657FZ	Z	High Flow	3/8 in. NPT	1/4 in.	300 psi	Steel/Aluminum*	(1) FNPT Coupler, (1) MNPT Coupler, (2) FNPT Plug and (3) MNPT Plug	●
14-Pc. Coupler and Plug Kit								
A53458FZ	Z	High Flow	1/4 in. NPT	1/4 in.	300 psi	Steel/Aluminum*	(2) FNPT Coupler, (2) MNPT Coupler, (4) FNPT Plug and (6) MNPT Plug	●
3-Way Manifold								
A86666FZ	Z	High Flow	3/8 in. NPT	1/4 in.	300 psi	Steel/Aluminum*	(1) 3-Way Flat Hex Manifold, (3) A53626FZ and (1) A53640FZ	●

*Nickel Plated Steel with Anodized Aluminum Sleeve

Heavy Duty Safety Couplers and Plugs

PRO

Flexzilla® Pro Heavy Duty Safety Couplers and Plugs feature ZVR™ Technology, Zero Valve Restriction provides maximum CFM possible. Paired with quick, safe and easy connections, Flexzilla Pro HD Couplers and Plugs are the best choice for maximum performance from your air tools.

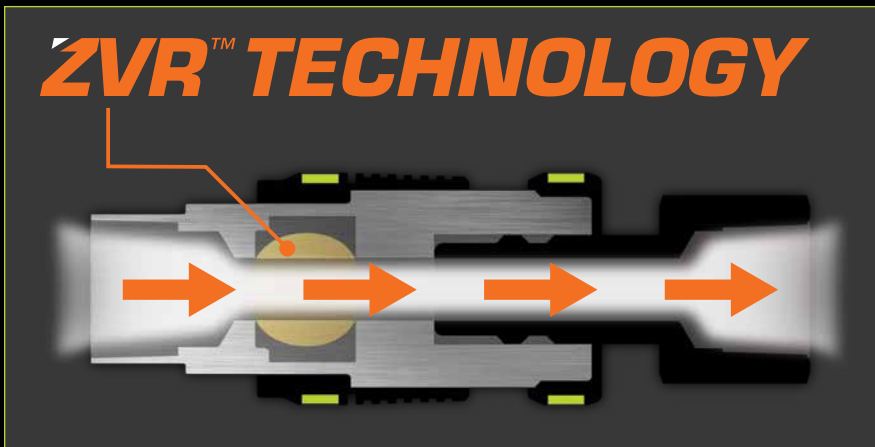

FEATURES:

- **ZVR™ Technology** - Zero Valve Restriction provides absolute throughput and feeds your tool the maximum CFM possible
- **Safety Coupler** - Connect and disconnect under zero pressure
- Non-marring



QUICK, SAFE & EASY CONNECTIONS

ENGAGE AT ZERO PRESSURE

DISENGAGE AT ZERO PRESSURE



Push-to-connect under zero pressure



Push sleeve up to open valve and engage air flow



Pull sleeve down to shut off air flow and pull top collar down to disengage plug under zero pressure

Heavy Duty Safety Couplers and Plugs

PRO

Couplers

Part No.	Type	Interchange	Connection Size	Body Size	Max. Pressure	Material	Retail Packaging
Heavy Duty Safety Couplers							
A55618FZ	H	Industrial	3/8 in. FNPT	1/2 in.	175 psi	Multiple*	●
A55628FZ	H	Industrial	3/8 in. MNPT	1/2 in.	175 psi	Multiple*	●
A55818FZ	H	Industrial	1/2 in. FNPT	1/2 in.	175 psi	Multiple*	●
A55828FZ	H	Industrial	1/2 in. MNPT	1/2 in.	175 psi	Multiple*	●
*Nickel Plated Steel and ABS							



Plugs

Part No.	Type	Interchange	Connection Size	Body Size	Max. Pressure	Material	Retail Packaging
Heavy Duty Safety Plugs							
A55630FZ	H	Industrial	3/8 in. FNPT	1/2 in.	232 psi	Nickel Plated Steel	●
A55640FZ	H	Industrial	3/8 in. MNPT	1/2 in.	232 psi	Nickel Plated Steel	●
A55830FZ	H	Industrial	1/2 in. FNPT	1/2 in.	232 psi	Nickel Plated Steel	●
A55840FZ	H	Industrial	1/2 in. MNPT	1/2 in.	232 psi	Nickel Plated Steel	●

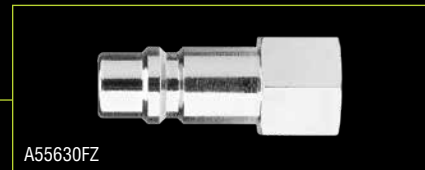

Heavy Duty Safety Coupler and Plug Kits

PRO

Part No.	Type	Interchange	Connection Size	Body Size	Max. Pressure	Material	Contents	Retail Packaging
5-Pc. Coupler and Plug Kits								
A55656FZ	H	Industrial	3/8 in. NPT	1/2 in.	175 psi	Multiple*	(1) FNPT Coupler, (1) MNPT Coupler, (1) FNPT Plug, and (2) MNPT Plugs	●
A55856FZ	H	Industrial	1/2 in. NPT	1/2 in.	175 psi	Multiple*	(1) FNPT Coupler, (1) MNPT Coupler, (1) FNPT Plug, and (2) MNPT Plugs	●
*Nickel Plated Steel and ABS								



MODULAR ACCESSORIES SYSTEM

Includes needle tips, chip guards, extensions and OSHA-compliant safety nozzles.



INCREASED AIR FLOW

Variable flow trigger that can be tailored to a high power job or delicate precision work.

BLOW GUNS

THOUGHTFULLY DESIGNED

Ergonomic handle and rubberized grip.

Modular Blow Guns

Introducing Flexzilla™ Blow Guns and accessories. Flexzilla features an ergonomically superior gun body for maximum comfort and control which reduces operator fatigue. A variable flow trigger regulates air volume precisely with maximum flow, equal to or greater than the competition. The exclusive modular accessories system allows the Flexzilla blow guns to be customized for extension length and tips needed for any job. Flexzilla safety nozzles and bendable extension are labeled to meet or exceed OSHA standards.

BLOW GUN FEATURES:

- **Variable flow trigger** - regulates air volume precisely with maximum flow, equal to or greater than the competition (X3™ Blow Guns only)
- **Brass valve seat and trigger pin** - for better sealing and durability (X1™ Blow Guns only)
- **Ergonomic handle** - for comfort and easy handling
- **Storage hook** - for easy storage
- **1/4 in. NPT inlet**



Part No.	Description	CFM	dBA	Variable Flow Trigger	Meets OSHA Number	Line psi	Retail Packaging
AG1102FZ	Flexzilla™ X3™ Blow Gun with Quiet-Flo Safety Nozzle	36	87	●	1910.95 (a), 1910.242 (b)	100	●
AG1202FZ	Flexzilla™ X3™ Blow Gun with Xtreme-Flo Safety Nozzle	50	99	●	1910.242 (b)	100	●
AG1402FZ	Flexzilla™ X1™ Blow Gun with Quiet-Flo Safety Nozzle	36	87	–	1910.95 (a), 1910.242 (b)	100	●
AG1502FZ	Flexzilla™ X1™ Blow Gun with Xtreme-Flo Safety Nozzle	43	99	–	1910.242 (b)	100	●

Modular Blow Gun Kits

Flexzilla™ X3™ 6-Pc. Blow Gun Kit

AG1200FZKIT INCLUDES:

- a – Flexzilla X3 Blow Gun - with Variable Flow Trigger
- b – 6 in. Extension
- c – Chip Guard
- d – Tri-Thrust Safety Nozzle
- e – Xtreme-Flo Safety Nozzle
- f – Quiet-Flo Safety Nozzle

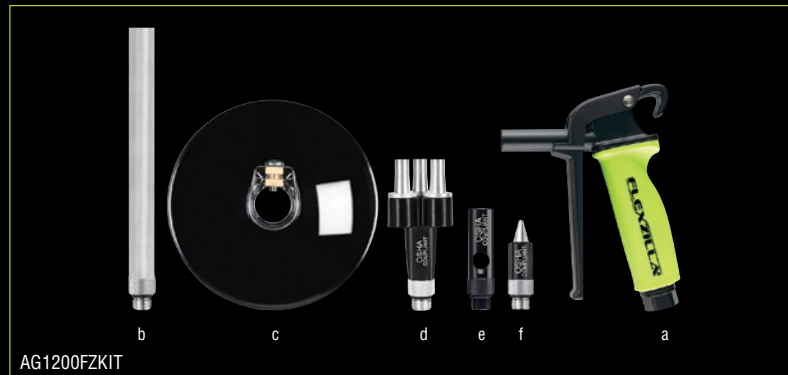

Flexzilla™ X1™ 10-Pc. Blow Gun Kit

AG1500FZKIT INCLUDES:

- a – Flexzilla X1 Blow Gun
- b – 6 in. Extensions (x2)
- c – Needle Tips (1 in., 2 in. & 3 in.)
- d – Xtreme-Flo Safety Nozzle
- e – Quiet-Flo Safety Nozzle
- f – Rubber Tip
- g – Tip Adapter

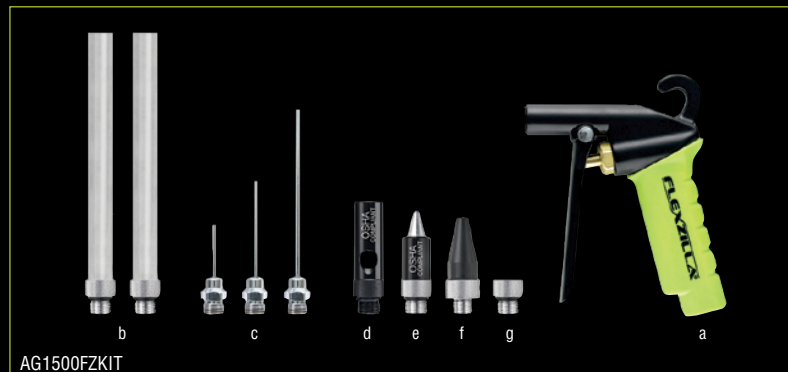

Part No.	Retail Packaging
AG1200FZKIT	●
AG1500FZKIT	●

Modular Blow Guns Accessories System

The exclusive modular accessories system (sold separately) allows the Flexzilla™ blow guns to be customized for extension length and tips needed for any job. Flexzilla safety nozzles and bendable extension are labeled to meet or exceed OSHA standards. Extensions can be combined up to 6 feet.

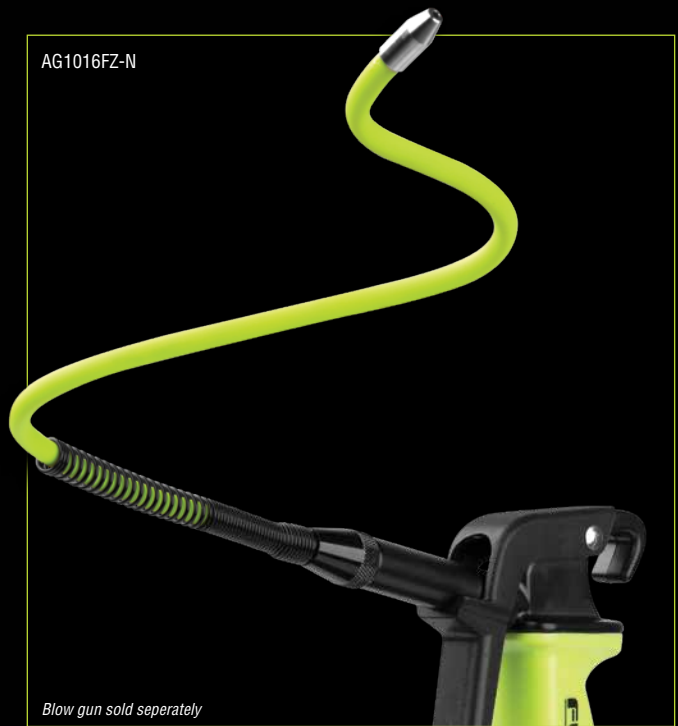
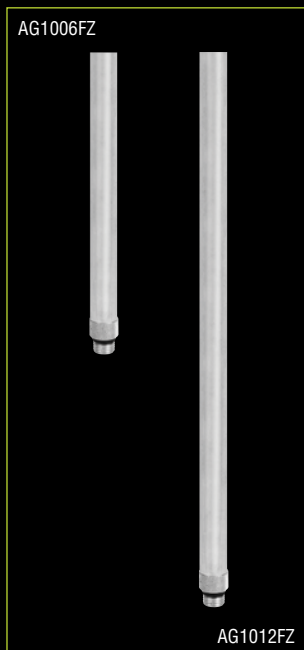
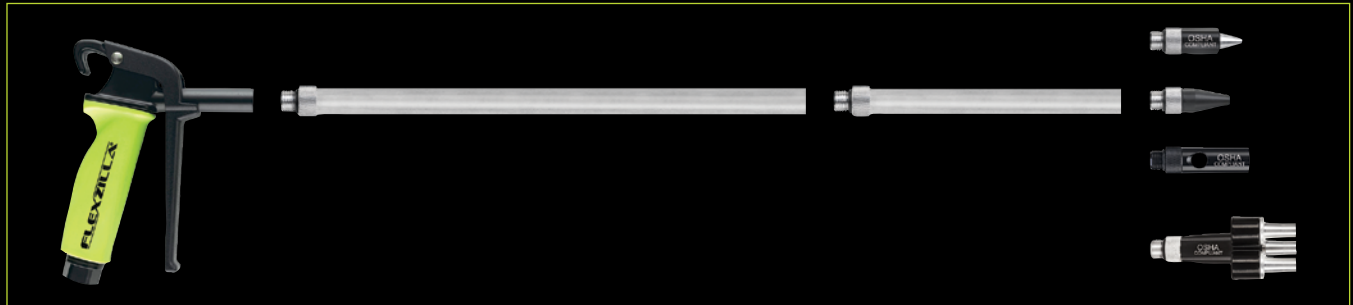

Part No.	Description	Retail Packaging
AG934FZ	Flexzilla™ Rubber Tip	●
AG1090FZ	Flexzilla™ Xtreme-Flo Safety Nozzle	●
AG1091FZ	Flexzilla™ Quiet-Flo Safety Nozzle	●
AG1093FZ	Flexzilla™ Tri-Thrust Safety Nozzle	●
AG1099FZ	Flexzilla™ 5-Pc. Tip Adapter Kit	●
AG1092FZ	Flexzilla™ Chip Guard	●
AG1006FZ	Flexzilla™ 6 in. Extension	●
AG1012FZ	Flexzilla™ 12 in. Extension	●
AG1016FZ-N	Flexzilla™ 16 in. Bendable Extension	●

BREAKAWAY TORQUE

Delivers 800 ft-lbs. of nut-busting breakaway torque.

AIR TOOLS

LIGHTWEIGHT & COMPACT

Making it easy to get into those hard to reach areas.

Mini Impact Wrench



PRO

Proving once again you don't have to be big to be powerful. Flexzilla® Pro Air Tools pack high RPM and maximum torque into the lightest, most compact air tools on the market. The mini impact wrench has 800 ft.-lbs. of nut-busting breakaway torque and an extremely lightweight design.

Flexzilla Pro Mini Impact Wrench (AT1475FZ)

FEATURES:

- 800 ft.-lbs. of nut-busting breakaway torque
- Compact design – Ideal for tight spaces, 4.4 in.
- Torque selector – Maximum torque, 550 ft.-lbs.
- Extremely lightweight – Composite design, 2.5 lbs.
- Patented Forward/Reverse toggle switch
- Handle exhaust – Directs air away from user
- 1/4 in. NPT air inlet with built-in swivel
- Ergonomic grip
- High speed, 9500 RPM
- Air Consumption: 4.8 CFM
- Drive: 1/2 in.

INCLUDES:

- Flexzilla Pro Mini Impact Wrench
- Flexzilla Pro High Flow 1/4 in. MNPT Ball Swivel Plug

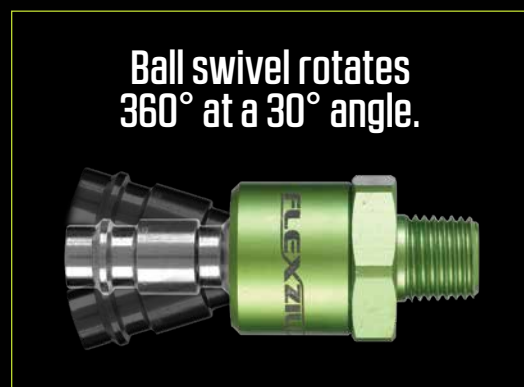

AT1475FZ

Part No.	Retail Packaging
AT1475FZ	●

TORQUE	DRIVE
800 FT-LBS.	1/2 IN.
HIGH SPEED	AIR CONSUMPTION
9500 RPM	4.8 CFM



CLICK HERE

to see Flexzilla® Pro Air Tools in action!

TIRE MAINTENANCE

INFLATE AND MONITOR

Inflate and check tire pressure simultaneously at a safe distance.

Tire Inflators



Tire inflators deliver accurate pressure to car, truck, bike, and off-road tires.



AL2000FZ

AL2000FZ FEATURES:

- Range: 20 to 170 psi
- Straight-on chuck with 12 in. air hose
- Heavy-duty gauge
- Indicator bar is calibrated in 2 psi increments from 20 to 100 ps



AL2025FZ-1

AL2025FZ-1 FEATURES:

- Range: 10 to 170 psi
- Quick-connect coupler and plug
- Trigger actuated deflate function
- Straight lock-on connector
- Dial gauge with protective rubber guard
- Includes: 3 ft. air hose extension



AL2025FZ-2

AL2025FZ-2 FEATURES:

- Range: 10 to 170 psi
- Quick-connect coupler and plug
- Trigger actuated deflate function
- Straight lock-on connector
- Dial gauge with protective rubber guard
- Includes: 3 and 15 ft. air hose extensions
- OSHA Compliant - 15 ft. hose only



Part No.	Type	Hose I.D.	Hose Length	Inlet	Body Material	Retail Packaging
AL2000FZ	Tire Inflator	1/4 in.	1 ft.	1/4 in. FNPT	Die-cast Zinc	●
AL2025FZ-1	Inflator	1/4 in.	3 ft.	1/4 in. FNPT	Nylon/Brass	●
AL2025FZ-2	Inflator Kit	1/4 in.	3 ft. & 15 ft.	1/4 in. FNPT	Nylon/Brass	●
HGH2-FZ	Truck Tire Inflator Kit	3/8 in.	50 ft.	1/4 in. MNPT	-	●

Truck Tire Inflator Kit



The Flexzilla® truck tire inflator kit uses a truck's on-board air supply to inflate tires in remote situations.

HGH2-FZ INCLUDES:

- 3/8 in. x 50 ft. air hose
- Glad-hand attachment
- 30° Dual air chuck



HGH2-FZ

EXCLUSIVE SWIVELGRIP®

SwivelGrip® allows the hose and grip to rotate independently, releasing coils naturally, easily and effortlessly. The large, comfortable gripping surface on both ends of the hose lets you use the power of your entire hand to make tight connections easy.

(SwivelGrip® Patent Pending)

WATER HOSES

EXTREME ALL-WEATHER FLEXIBILITY

Lightweight and easy to handle, Flexzilla® hoses lay flat and have no memory, even in extreme weather conditions.

FLEXIBLE HYBRID POLYMER™

Flexzilla hoses have a durable, abrasion-resistant outer cover.

SwivelGrip® Garden and Lead-in Hose Assemblies



Premium Flexzilla® SwivelGrip® Garden Hose makes it easier to work around your home and lawn. SwivelGrip action eliminates twists that occur when uncoiling a hose. Conventional garden hose can trap coils that tighten into kinks as you move across the yard. SwivelGrip allows the hose and grip to rotate independently, releasing coils naturally, easily and effortlessly. The large, comfortable gripping surface on both ends of the hose lets you use the power of your entire hand to make tight connections easy. Flexzilla SwivelGrip Garden Hoses are engineered with a lightweight Flexible Hybrid Polymer which lays flat, eliminates kinking under pressure and is drinking water safe.



HFZG550YWS

FEATURES:

- **Male and female SwivelGrip® Connections**
 - Hose and grip rotate independently
 - Makes connections and uncoiling easy
 - Naturally releases coils
- Extreme all-weather flexibility
- Durable outer cover resists abrasion, UV and mold
- Won't kink under pressure
- Lightweight and easy to handle
- Lays flat - no memory
- Reinforced mid-layering provides extra strength
- Anodized aircraft aluminum ends
- Max. working pressure at 70°F: 150 psi
- **Drinking water safe**



Part No.	Hose I.D.	Hose Length	Fittings	Retail Packaging
HFZG503YWS	5/8 in.	3 ft.	3/4 in. - 11½ GHT	●
HFZG505YWS	5/8 in.	5 ft.	3/4 in. - 11½ GHT	●
HFZG510YWS	5/8 in.	10 ft.	3/4 in. - 11½ GHT	●
HFZG510YWS-6X	5/8 in.	10 ft.	3/4 in. - 11½ GHT	●
HFZG525YWS	5/8 in.	25 ft.	3/4 in. - 11½ GHT	●
HFZG550YWS	5/8 in.	50 ft.	3/4 in. - 11½ GHT	●
HFZG550YWS-30X	5/8 in.	50 ft.	3/4 in. - 11½ GHT	●
HFZG550YWS-40X	5/8 in.	50 ft.	3/4 in. - 11½ GHT	●
HFZG575YWS	5/8 in.	75 ft.	3/4 in. - 11½ GHT	●
HFZG5100YWS	5/8 in.	100 ft.	3/4 in. - 11½ GHT	●

Part nos. with a -30X or -40X suffix include 30 or 40 hose assemblies respectively on a quarter pallet display

Part no. with a -6X suffix includes 6 hose assemblies in a retail merchandiser display



HFZG503YWS



HFZG550YWS

SWIVELGRIP®

HOSE & GRIP ROTATE INDEPENDENTLY

MAKES CONNECTIONS & UNCOILING EASY

TIGHT
LEAK-FREE
CONNECTIONS

- A large grip lets you use the power of your entire hand to make tight connections easy
- A durable O-ring provides long lasting leak-free connections

Garden Hose Merchandiser and Pallets



Garden Hose Merchandiser Tray

Garden Hose Quarter Pallet

Garden Hose Pallet

Colors™ SwivelGrip® Garden Hose Assemblies



From the makers of Flexzilla®, Colors™ Garden Hose makes it easier to work around your home and lawn. SwivelGrip action eliminates twists that occur when uncoiling a hose. Conventional garden hose can trap coils that tighten into kinks as you move across the yard. SwivelGrip allows the hose and grip to rotate independently, releasing coils naturally, easily and effortlessly. The large, comfortable gripping surface on both ends of the hose lets you use the power of your entire hand to make tight connections easy. Premium Colors™ Garden Hose features the same Flexible Hybrid Polymer material as our renowned ZillaGreen® hoses, but comes in earthy colors ideal for a variety of landscapes.



HFZC550BRS



HFZC550BRS



HFZC550TCS

SWIVELGRIP® FEATURES:

- Male and female SwivelGrip® Connections
 - Hose and grip rotate independently
 - Makes connections and uncoiling easy
 - Naturally releases coils

Part No.	Color	Hose I.D.	Hose Length	Fittings	Retail Packaging
HFZC550BRS	Brown Mulch	5/8 in.	50 ft.	3/4 in. - 1 1/2 GHT	●
HFZC550TCS	Red Clay	5/8 in.	50 ft.	3/4 in. - 1 1/2 GHT	●



Garden and Lead-in Hose Assemblies



Flexzilla® Garden Hose is engineered with a Flexible Hybrid Polymer that is both lightweight and durable. This premium hose redefines flexibility and is easy to maneuver around your yard. Flexzilla Garden Hose has zero memory which allows the hose to lay flat and ensures that sprinklers stay put without twisting. Its durable outer cover is abrasion-resistant, and the reinforced mid-layering provides extra strength. Plus, with our superior O-ring, you get a long-term, leak-free connection at the spigot. The Flexible Hybrid Polymer inner tube material is drinking water safe.



HFZG550YW



HFZG503YW



HFZG510YW



HFZG550YW

Part No.	Hose I.D.	Hose Length	Fittings	Retail Packaging
HFZG503YW	5/8 in.	3 ft.	3/4 in. - 1 1/2 GHT	●
HFZG505YW	5/8 in.	5 ft.	3/4 in. - 1 1/2 GHT	●
HFZG510YW	5/8 in.	10 ft.	3/4 in. - 1 1/2 GHT	●
HFZG525YW	5/8 in.	25 ft.	3/4 in. - 1 1/2 GHT	●
HFZG550YW	5/8 in.	50 ft.	3/4 in. - 1 1/2 GHT	●
HFZG550YW-48T	5/8 in.	50 ft.	3/4 in. - 1 1/2 GHT	●
HFZG575YW	5/8 in.	75 ft.	3/4 in. - 1 1/2 GHT	●
HFZG575YW-48T	5/8 in.	75 ft.	3/4 in. - 1 1/2 GHT	●
HFZG5100YW	5/8 in.	100 ft.	3/4 in. - 1 1/2 GHT	●
HFZG5100YW-36T	5/8 in.	100 ft.	3/4 in. - 1 1/2 GHT	●
HFZG650YW*	3/4 in.	50 ft.	3/4 in. - 1 1/2 GHT	●
HFZG675YW*	3/4 in.	75 ft.	3/4 in. - 1 1/2 GHT	●
HFZG6100YW*	3/4 in.	100 ft.	3/4 in. - 1 1/2 GHT	●

Part nos. with a -36T or -48T suffix include 36 or 48 hose assemblies respectively on a pallet display

* Not certified by IAPMO to be in compliance with NSF/ANSI 61: Drinking Water System Components



Garden Hose Kit with Quick Connect Attachments



The Flexzilla® Garden Hose Kit with Quick Connect Attachments features Flexible Hybrid Polymer material with extreme all-weather flexibility that allows hose to lie flat and won't kink under pressure. It's lightweight and coils easily. The convenient Flexzilla Garden Hose Kit comes with hose, twist action nozzle, quick connect flow-stop coupler, spigot adapter, hose adapters and hose hanger to make gardening a snap.



Part No.	Hose I.D.	Hose Length	Fittings	Retail Packaging
HFZG12050QN	1/2 in.	50 ft.	3/4 in. - 1 1/2 GHT	●

HOSE FEATURES:

- Extreme all-weather flexibility
- Won't kink under pressure
- Lightweight, coils easily
- Lays flat - no memory
- Durable outer cover resists abrasion, UV and mold
- Reinforced mid-layering provides extra strength
- Quick connect couplers
- Max. working pressure at 70°F: 150 psi
- Drinking water safe

SPRAY NOZZLE FEATURES:

- Soft mist for flowers and plants
- Jet spray for long distances (up to 20 ft.)

GARDEN HOSE KIT INCLUDES:

- a – Flexzilla Garden Hose with Quick Connect Couplers
- b – Hose Hanger
- c – Quick Connect Spray Nozzle
- d – Quick Connect Spigot Adapter
- e – (2) Quick Connect Attachment Adapters



3-Piece Nozzle Kit with Quick Connections

KIT INCLUDES:

- Quick Connect Spray Nozzle
 - Soft mist for flowers and plants
 - Jet spray for long distances (up to 20 ft.)
- Flow-Stop Coupler – Prevents user from being sprayed when connecting and disconnecting
- Quick Connect Attachment Adapter – Easily connect to sprinkler or other attachments

Part No.	Retail Packaging
HFZGAK01	–
HFZGAK02	●



NEW

Quick Connect Garden Hose Fittings

Flexzilla™ Quick-Connect Garden Hose Fittings make connecting and disconnecting attachments fast and easy. Switch out nozzles and sprinklers in a snap by attaching an adapter to all of your favorite watering tools. Connect Flow-Stop Couplers for effortless connections to adapters and spigots. Plus, our Flow-Stop Couplers automatically stop water flow, preventing spray back when connecting and disconnecting the hose. Add convenient, water-tight connections from the spigot to sprayer with Flexzilla Quick-Connect Garden Hose Fittings.

COMMON FEATURES:

- Flow-Stop Coupler prevents user from being sprayed when connecting and disconnecting
- Easily connect to standard garden hose threads (3/4 in. - 1 1/2 GHT)
- Compatible with Flexzilla® Quick-Connect Flow-Stop Couplers and Water Hose Adapters

Part No.	Description	Retail Packaging
HFZGAK11	2-Piece Coupler & Plug Kit	●
HFZGAK12	3-Piece Coupler & Plug Kit	●
HFZGAK13	5-Piece Plug Kit	●
HFZGAK14	5-Piece Coupler & Plug Kit	●



HFZGAK11

HFZGAK11 KIT INCLUDES:

- (1) Quick-Connect Coupler, Male
- (1) Quick-Connect Water Hose Adapter, Female Plug



HFZGAK12

HFZGAK12 KIT INCLUDES:

- (1) Quick-Connect Flow-Stop Coupler, Female
- (2) Quick-Connect Water Hose Adapters, Male Plugs



HFZGAK13

HFZGAK13 KIT INCLUDES:

- (1) Quick-Connect Water Hose Adapter, Female Plug
- (4) Quick-Connect Water Hose Adapters, Male Plugs



HFZGAK14

HFZGAK14 KIT INCLUDES:

- (1) Quick-Connect Flow-Stop Coupler, Female
- (1) Quick-Connect Coupler, Male
- (1) Quick-Connect Water Hose Adapter, Female Plug
- (2) Quick-Connect Water Hose Adapters, Male Plugs

NEW Marine Twin Outboard Flush Kit, 6-Piece

Never leave your boat after turning on the water! This convenient and time saving Flexzilla® Marine Flush Kit allows you to flush twin outboard motors without the hassle of getting on and off the boat before turning on the water. The 6-piece kit features SwivelGrip® water hose engineered with flexible hybrid polymer material, a large grip, leak-free connections, dual on/off y-splitter, and quick-connect adapters. The automatic quick-connect flow-stop coupler prevents the user from being sprayed when connecting and disconnecting. Plus, the quick-connect nozzle allows you use the main hose to wash down your boat. The kit is lightweight, compact and easy to store on board any boat.

FEATURES:

- SwivelGrip® Water Hose - Ends make connections fast and easy. A large grip lets you use the power of your entire hand to make tight connection to your outboard motor easy
- Y-Splitter with Dual On/Off Valves - The splitter allows you to feed water into twin outboard motors at the same time or it can be used to flush one motor at a time
- Quick-Connect Flow-Stop Coupler - Turn on water at the spigot and connect flush kit to main hose. Coupler prevents user from being sprayed when connecting and disconnecting
- Quick-Connect Adapters - Make it easy to connect the flush kit
- Quick-Connect Nozzle - The soft mist to jet spray pattern makes it easy to wash down the boat
- Convenient and Time Saving Kit - No more hassle of getting on and off the boat before turning on the water
- For use on board or while the boat is on the trailer

KIT INCLUDES:

- (2) 3 ft. Flexzilla SwivelGrip Water Hoses
- (1) Dual On/Off Y-Splitter
- (1) Quick-Connect Flow-Stop Coupler - Female
- (1) Quick-Connect Water Hose Plug - Male
- (1) Quick-Connect Spray Nozzle



CONVENIENT AND TIME SAVING...

Never leave your boat after turning on the water!

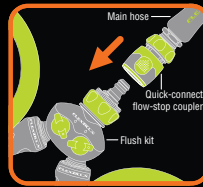

QUICK-CONNECT COUPLER WITH AUTO FLOW-STOP

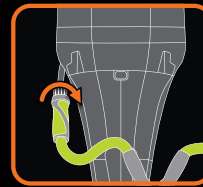

SWIVELGRIP® ENDS MAKE CONNECTIONS FAST AND EASY



DUAL ON/OFF VALVES

NEW 2-Way Hose Splitter



The Flexzilla™ 2-Way Hose Splitter eliminates the frustration of switching out hoses by creating two water sources from a single spigot.

FEATURES:

- Twist action on/off valves - Controls water flow for two hoses
- Soft grip swivel nut for easy connections
- Spigot adapter: 1 in. to 3/4 in. GHT reducer bushing
- For outdoor and shop use: 40° to 120°F
- Leak-free O-ring
- Works with standard water hose or sprinklers

Part No.	Fitting Size	Retail Packaging
HFZGA60	1 in. or 3/4 in. GHT	●

NEW Garden Hose Nozzles

Flexzilla™ Garden Hose Nozzles are designed for a wide range of watering needs and are suitable for gardening, cleaning, washing your car, or showering dogs and pets. They are available in a variety of styles, are simple to operate and built to withstand of tough use.

COMMON FEATURE:

- Leak-free connections - O-ring seal provides secure, watertight connections to garden hoses



NFZG51

NFZG51 FEATURES:

- Thumb actuated pressure control - adjusts from maximum spray to gentle flow
- Heavy duty and durable metal construction
- Variable flow pattern - Soft mist to jet spray
- Soft grip dial guard
- Comfortable non-slip rubber grip



NFZG52

NFZG52 FEATURES:

- Thumb actuated pressure control - adjusts from maximum spray to gentle flow
- Heavy duty and durable metal construction
- 7 adjustable spray patterns: jet, rinse, center, shower, cone, mist, flat
- Soft grip dial guard
- Comfortable non-slip rubber grip



NFZG61

NFZG61 FEATURES:

- Thumb actuated design - 3 position
- Heavy duty metal construction
- Adjustable spray patterns: shower, flat, jet
- Soft grip dial guard
- Ergonomic soft grip handle



NFZG21

NFZG21 FEATURES:

- Soft mist for flowers and plants
- Jet spray for long distances (up to 20 ft.)
- Soft grip outer housing
- Compact design



NFZG62

NFZG62 FEATURES:

- Variable flow pattern - Soft mist to jet spray
- Heavy duty metal construction
- Soft grip outer housing
- Compact design



NFZG63

NFZG63 FEATURES:

- Adjustable spray patterns: shower, full, jet, cone
- Soft grip dial guard

Part No.	Description	Retail Packaging
NFZG21	Twist Action Garden Hose Nozzle - 4-Pattern	●
NFZG51	Heavy Duty Twist Action Adjustable Flow Garden Hose Nozzle	●
NFZG52	Heavy Duty 7-Pattern Adjustable Flow Garden Hose Nozzle	●
NFZG61	Heavy Duty Pistol Grip Garden Hose Nozzle	●
NFZG62	Heavy Duty Twist Action Garden Hose Nozzle	●
NFZG63	Twist Action Garden Hose Nozzle - 4-Pattern	●

NEW Garden Hose Nozzles (continued)



NFZG64

NFZG64 FEATURES:

- On/Off toggle switch with variable flow
- 6 adjustable spray patterns: mist, vertical, shower, cone, flat, jet
- Durable outer housing
- Soft grip dial guard
- Lightweight soft grip handle



NFZG65

NFZG65 FEATURES:

- Rotate nozzle to adjust water flow from a fine mist to a powerful jet stream
- Twist action knob that allows adjustable water flow
- On/off trigger with locking mechanism
- Comfortable non-slip rubber grip
- Compact and lightweight design
- Durable outer housing



NFZG66

NFZG66 FEATURES:

- 7 adjustable spray patterns: mist, flat, cone, center, shower, jet, spout
- On/off trigger with locking mechanism
- Comfortable non-slip rubber grip
- Compact and lightweight design
- Durable outer housing



NFZG67

NFZG67 FEATURES:

- Heavy duty and durable metal construction
- 7 adjustable spray patterns: mist, vertical, shower, center, cone, flat, jet
- Flow control dial allows greater watering control
- On/off trigger with locking mechanism
- Soft grip dial guard
- Twice rubberized grip for extra comfort



NFZG68

NFZG68 FEATURES:

- Adjustable pressure control - adjusts from maximum spray to gentle flow
- Heavy duty metal construction
- Rotate nozzle to adjust water flow from a fine mist to a powerful jet stream
- Soft grip dial guard
- Ergonomic soft grip handle



NFZG69

NFZG69 FEATURES:

- Adjustable pressure control - adjusts from maximum spray to gentle flow
- Heavy duty metal construction
- 7 adjustable spray patterns: mist, vertical, shower, center, cone, flat, jet
- Soft grip dial guard
- Ergonomic soft grip handle

Part No.	Description	Retail Packaging
NFZG64	Adjustable Garden Hose Nozzle - 6-Pattern	●
NFZG65	Metal Adjustable Pistol Grip Garden Hose Nozzle	●
NFZG66	Metal 7-Pattern Adjustable Pistol Grip Garden Hose Nozzle	●
NFZG67	Heavy Duty 7-Pattern Adjustable Pistol Grip Garden Hose Nozzle	●
NFZG68	Heavy Duty Adjustable Flow Pistol Grip Garden Hose Nozzle	●
NFZG69	Heavy Duty 7-Pattern Adjustable Flow Pistol Grip Garden Hose Nozzle	●

NEW Garden Hose Nozzles (continued)

NFZG70 FEATURES:

- Angle adjustable head with 180° rotation
- 28 in. wand to water hanging planters, new plantings and delicate flowers
- On/Off toggle switch with variable flow control and prevention of user fatigue
- 3 adjustable spray patterns: jet, mist, shower
- Soft grip dial guard
- Durable outer housing
- Lightweight soft grip handle

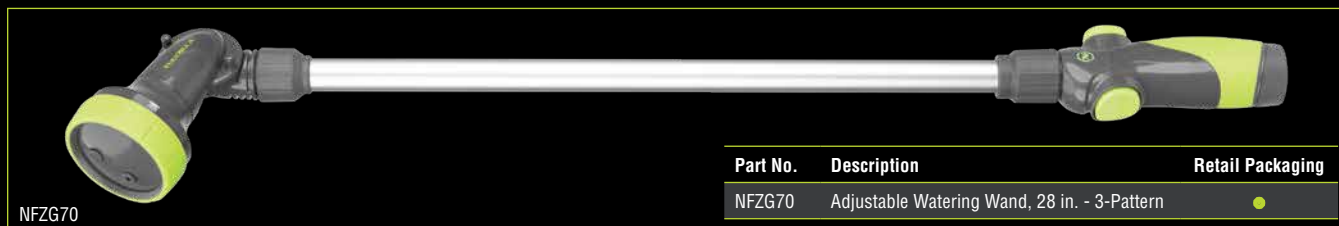

NEW Lawn Sprinklers



**WATER AREA UP TO
2,400 SQ. FT.**

Flexzilla™ Oscillating Lawn Sprinklers are essential tools for watering your lawn or garden. Waters a range up to 2,400 sq. ft. using 18 durable plastic nozzles. The range adjustment collar allows you to set the precise coverage area to efficiently water your yard. Our proven design makes this sprinkler ideal for everyday watering needs.



COMMON FEATURES:

- Range adjustment collar makes it easy to position water where you need it without wasting water on the sidewalk or driveway
- 18 plastic jet nozzles cover up to 2,400 sq. ft. in your lawn or garden
- Clog resistant filter allows water to flow evenly
- Nozzle cleaning tool and end plug
- Leak-free connections - Rubber gasket provides secure, watertight connections to garden hoses

SFZG62 FEATURES:

- Metal Base - Ensures the sprinkler stays in place and does not flip over during use.

Part No.	Description	Retail Packaging
SFZG61	Oscillating Lawn Sprinkler, 2,400 sq. ft.	●
SFZG62	Oscillating Lawn Sprinkler with Metal Base, 2,400 sq. ft.	●



Water Hose Nozzles

PRO

FEATURES:

- Precision flow port – Inline connection allows water to flow directly, not up and through the handle – increases water flow, pressure and power by approximately 30%
- Multiple spray patterns – Select from jet, fan, power or low flow spray – perfect for any job in the shop, garage or home
- Ergonomic handle provides an easy grip for less user fatigue
- Machined aircraft aluminum barrel and Santoprene™ rubber handle and head
- Durable, non-marring outer cover that protects painted surfaces
- Leak-free O-ring - outlasts the competition
- Works with 1/2, 5/8 and 3/4 in. water hose



FIELD REPAIRABLE



CUSTOM LENGTHS

Flexzilla® Pro Water Hose is available in pre-assembled coils or in our Custom Hose Centers where the end user can fabricate a custom length hose for any application. The field repair and custom length hose process takes

3 EASY STEPS



CUT – Remove damaged portion of hose or measure and cut desired length at 90° angle.



INSTALL – Slide spiral fitting and nut onto hose. Push hose onto fitting until hose reaches threads.



TIGHTEN – Tighten fitting nut until snug. Slide bend restrictor up and snap onto nut.

Custom Water Hose Center



PRO

The Flexzilla® Pro Custom Water Hose Centers allow you to provide your customers with custom length hose. Using Flexzilla Pro reusable ends, you can quickly and easily create custom length hose assemblies on site. The Custom Water Hose Centers also include Flexzilla SwivelGrip® Garden lead-in hose assemblies.



HFZWHC1

SwivelGrip® Garden Lead-In hoses are not field repairable

Custom Water Hose Center (continued)



PRO

Part No.	Description	Rack Quantity
HFZWHC1 - Flexzilla® Pro Custom Water Hose Center		
HFZW58250YW	Flexzilla® Pro Water Hose, 5/8 in. x 250 ft. Spool, ZillaGreen™	3 ea.
RP900625F	Flexzilla® Pro Water Hose Female Reusable Fitting, 5/8 in.	30 ea.
RP900625M	Flexzilla® Pro Water Hose Male Reusable Fitting, 5/8 in.	30 ea.
HFZG503YWS	Flexzilla® Garden Lead-in Hose with SwivelGrip™, 5/8 in. x 3 ft.	10 ea.
HFZG510YWS	Flexzilla® Garden Lead-in Hose with SwivelGrip™, 5/8 in. x 10 ft.	20 ea.
HR-05	Custom Hose Center (Freestanding Rack)	1 ea.

Parts also sold separately in standard pack quantities



Water Hose Assemblies



PRO

Flexzilla® Pro Water Hose was designed for professional use. It offers all the unique, efficient qualities of other Flexzilla hoses – it's lightweight, it lies flat, it's flexible in any weather, durable and abrasion-resistant and it will not kink when under water pressure. Also, it's easily repaired on the jobsite in a few simple steps. Plus, with our superior O-ring, you get a long-term, leak-free connection at the spigot. The Flexible Hybrid Polymer inner tube material is drinking water safe.

FEATURES:

- Field Repairable – Reusable anodized aircraft aluminum fittings
- Extreme all-weather flexibility
- Lightweight, coils easily
- Won't kink under pressure
- Lays flat - no memory
- Durable outer cover resists abrasion, UV and mold
- Reinforced mid-layering provides extra strength
- Leak free connections - A durable O-ring provides long lasting leak free connections
- Max. working pressure at 70°F: 150 psi
- Flexzilla Pro Reusable Fittings include bend reinforcement for increased flexibility. Reduces wear and tear, prolonging the life of the hose.
- Drinking water safe



Part No.	Hose I.D.	Hose Length	Fittings	Retail Packaging
HFZWP550	5/8 in.	50 ft.	3/4 in. - 1 1/2 GHT	●
HFZWP575	5/8 in.	75 ft.	3/4 in. - 1 1/2 GHT	●
HFZWP5100	5/8 in.	100 ft.	3/4 in. - 1 1/2 GHT	●

Retractable Water Hose Reel with Levelwind™ Technology



Featuring Levelwind™ – Flexzilla’s unique winding system that automatically layers hose back and forth across the reel ensuring that the hose is coiled smoothly, easily...every time – and includes Flexzilla® water hose and lead-in hose.



L8340FZ



Levelwind™ Technology
Layers the hose evenly, easily...every time!

FEATURES:

- **Latching Mode Switch** – Choose from latching hose every 3 ft. for extended use or switch to free run for immediate automatic rewinding
- **Seven Position Locking Bracket** – These reels can swivel freely on the mounting bracket up to 135° or can be locked into place using the locking brace. Up to seven different locking angles can be utilized (L8300-W)
- **Adjustable Hose Stopper** – Increase or decrease the length of the hose that remains when hose is fully retracted
- **Extra Large Swivel** – A 3/4 in. swivel reduces flow restriction and allows maximum flow
- **Freestanding Base** – Portable - Use freestanding or mounted on wall or ceiling. Flat base allows reel to rest on ground
- **Built-In Handle** – For carrying ease
- **Durable Construction** – Made from durable UV stabilized polypropylene
- **Lead-in Hose Included** – 10 ft. x 3/4 in. x 1 1/2 GHT (L8340FZLI)

ASSEMBLED IN USA
of US and global components

Retractable Water Hose Reels with Levelwind™ Technology

Part No.	Hose I.D.	Hose Length	Hose Material	Working Pressure @ 70°F	Reel Inlet	Weight	Retail Packaging	Assembled in USA
L8340FZ	1/2 in.	70 ft.	Flexible Hybrid Polymer	150 psi	3/4 in. – 1 1/2 Male GHT	31 lbs.	●	●



Mounting Brackets

L8300-B FEATURES:

- Includes a seven position locking bracket
- Reel can swivel freely on mounting bracket up to 360° or can be locked into place using the locking brace
- Mounting options: high wall or bench

L8300-W FEATURES:

- Includes a seven position locking bracket
- Reel can swivel freely on mounting bracket up to 135° or can be locked into place using the locking brace
- Mounting options: wall or overhead ceiling

Pressure Washer Hose Assemblies

Flexzilla® offers a revolutionary pressure washer hose that redefines flexibility. Unlike other pressure washer hose, Flexzilla stays flexible when pressurized during use and offers minimal memory when depressurized. It also lays flat and won't work against you before, during or after use.



HFZPW3425M

FEATURES:

- Extreme flexibility under pressure, from subzero to 140°F
- Made of Flexible Hybrid Polymer material
- Integral non-kink bend restrictor
- Cold water use only
- Available with M22 or Integrated Quick Connect fittings

 **MADE IN USA**
of US and imported parts



HFZPW3425M



HFZPW3550M-3X

Part No.	Hose I.D.	Hose Length	Fittings	Yoke/Stem	Max. Working Pressure @ 70°F	Retail Packaging	Made in USA
HFZPW3425M	1/4 in.	25 ft.	M22	14mm	3,100 psi	●	●
HFZPW3425M-4X	1/4 in.	25 ft.	M22	14mm	3,100 psi	●	●
HFZPW3450M	1/4 in.	50 ft.	M22	14mm	3,100 psi	●	●
HFZPW3450M-3X	1/4 in.	50 ft.	M22	14mm	3,100 psi	●	●
HFZPW3525M	5/16 in.	25 ft.	M22	14mm	3,100 psi	●	●
HFZPW3525M-4X	5/16 in.	25 ft.	M22	14mm	3,100 psi	●	●
HFZPW3550M	5/16 in.	50 ft.	M22	14mm	3,100 psi	●	●
HFZPW3550M-3X	5/16 in.	50 ft.	M22	14mm	3,100 psi	●	●
HFZPW36425M	1/4 in.	25 ft.	M22	14mm	3,600 psi	●	●
HFZPW36425M-5X	1/4 in.	25 ft.	M22	14mm	3,600 psi	●	●
HFZPW36450M	1/4 in.	50 ft.	M22	14mm	3,600 psi	●	●
HFZPW36450M-3X	1/4 in.	50 ft.	M22	14mm	3,600 psi	●	●
HFZPW40525M	5/16 in.	25 ft.	M22	14mm	4,000 psi	●	●
HFZPW40525M-5X	5/16 in.	25 ft.	M22	14mm	4,000 psi	●	●
HFZPW40550M	5/16 in.	50 ft.	M22	14mm	4,000 psi	●	●
HFZPW40550M-3X	5/16 in.	50 ft.	M22	14mm	4,000 psi	●	●
HFZPW426050Q	3/8 in.	50 ft.	Integrated Quick Connect	—	4,600 psi	●	●
HFZPW426050Q-3X	3/8 in.	50 ft.	Integrated Quick Connect	—	4,600 psi	●	●
HFZPW426100Q	3/8 in.	100 ft.	Integrated Quick Connect	—	4,600 psi	●	●
HFZPW426100Q-2X	3/8 in.	100 ft.	Integrated Quick Connect	—	4,600 psi	●	●

Part nos. with -2x, -3X, -4X or -5X suffix include 2, 3, 4 or 5 hose assemblies respectively in a retail merchandiser display

LIGHTED PLUG

Light up any work site with the lighted power indicator, ensuring you can always find the power source.

GLOW STRIPE

Features a glow-in-the-dark stripe that runs the length of the cord.

EXTENSION CORDS

Extension Cords

PRO

Flexzilla® Pro industrial grade extension cords are engineered to hold up to the toughest jobs. They are easy to coil and remain flexible in temperatures as low as -58°F and up to 140°F. Plus, the grounded plug includes a lighted power indicator which lets you know power is running through the cord. Flexzilla Pro Extension Cords are ideal for outdoor industrial grade applications.

FEATURES:

- Extreme all-weather flexibility (-58°F to 140°F)
- Abrasion and corrosion-resistant
- Glow-in-the-dark stripe
- Power indicator light
- Resists kinks and easy to coil
- Grounded plug
- Water Resistant
- Flame Retardant
- Outdoor use
- cULus Listed



Part No.	Cord Length	Gauge	Retail Packaging
FZ512930	50 ft.	10 ga.	●
FZ512935	100 ft.	10 ga.	●
FZ512825	25 ft.	12 ga.	●
FZ512830	50 ft.	12 ga.	●
FZ512835	100 ft.	12 ga.	●
FZ512725	25 ft.	14 ga.	●
FZ512730	50 ft.	14 ga.	●
FZ512735	100 ft.	14 ga.	●



Flexzilla® Pro Extension Cords are manufactured by Prime Wire & Cable, Inc. in partnership with Legacy Manufacturing Company, and are distributed by both Prime Wire & Cable and Legacy Mfg. Co.



CLICK HERE

to see Flexzilla® Pro Extension Cords in action!

NEW Retractable Extension Cord Reels



Flexzilla® Retractable Extension Cord Reels come pre-loaded with 25 or 50 feet of oil-resistant cord, a lighted triple tap outlet and grounded 5 foot lead-in cord. Each reel also contains a circuit breaker with reset button, adjustable cord stopper, power indicator light, and a swivel mounting bracket. The reels lock the cord out in 1 foot increments. The impact resistant housing protects and stores the extension cord when not in use. These retractable reels are ideal for general, commercial and industrial use.



FZ8160253

GAUGE	CORD LENGTH
16/3 AWG	25 FT.



FZ8140503

GAUGE	CORD LENGTH
14/3 AWG	50 FT.

FEATURES:

- Lighted triple tap outlet for plenty of capacity
- Circuit breaker with reset button prevents breaker from tripping and blown fuses
- Reset circuit at reel
- Oil-Resistant AWG SJTOW cord flexible in low temperatures and resists the effects of oil, water and sunlight
- Swivel mounting bracket pivots in the direction of your work
- Reel can be mounted to wall or ceiling

- Cord locks out in 1 ft. increments
- Adjustable cord stopper ensures outlet is always within reach
- Power indicator light
- Grounded plug includes 5 ft. lead-in cord
- Impact resistant housing
- Recommended for dry, indoor locations
- cULus Listed



Part No.	Cord Length	Cord Gauge	Max. Watts	Max. Amps	Max. Voltage	Max. Hz	Retail Packaging
FZ8160253	25 ft.	16/3 AWG	1250W	10A	125V	60 Hz	●
FZ8140503	50 ft.	14/3 AWG	1625W	13A	125V	60 Hz	●

NEW Retractable Extension Cord Reel

PRO

The Flexzilla® Pro Retractable Extension Cord Reel comes pre-loaded with 60 feet of cord, a lighted triple tap outlet and grounded 4.5 foot lead-in cord. The 12 gauge oil resistant cord allows you to power heavy-duty equipment in the shop or on the jobsite. The reel utilizes a self-leveling system, which winds the cord evenly as it automatically retracts. The reel also contains a circuit breaker with reset button, adjustable cord stopper, power indicator light, and a swivel mounting bracket. The reel locks the cord out in 2 foot increments. The impact resistant housing protects and stores the extension cord when not in use. This retractable reel is ideal for commercial and industrial use.

FEATURES:

- Self-Leveling System winds the cord evenly
- Lighted triple tap outlet for plenty of capacity
- Circuit breaker with reset button prevents breaker from tripping and blown fuses. Reset circuit at reel
- Power indicator light
- Oil resistant 12/3 AWG SJTOW cord flexible in low temperatures and resists the effects of oil, water and sunlight
- Cord locks out in 2 ft. increments
- Adjustable cord stopper ensures outlet is always within reach
- Grounded plug includes 4.5 ft. lead-in cord
- Swivel mounting bracket pivots in the direction of your work. Reel can be mounted to wall or ceiling
- Impact resistant housing
- Recommended for dry, indoor locations



Grounded Plug



LISTED



FZ8120603

GAUGE	CORD LENGTH
12/3 AWG	60 FT.

Part No.	Cord Length	Cord Gauge	Max. Watts	Max. Amps	Max. Voltage	Max. Hz	Retail Packaging
FZ8120603	60 ft.	12/3 AWG	1875W	15A	125V	60 Hz	●

GREASING EQUIPMENT

FLEXZILLA® GREASE HOSE

Stays flexible, even in subzero temperatures.



LED LIGHTING

Keep your work space well-lit long after sundown.

RAPID RELOAD™ TECHNOLOGY

Push button technology that allows for quick cartridge loading and includes a threadless grease barrel.
(Rapid Reload™ Push Button Technology Patent Pending)



20V Cordless Grease Gun Kit

There is a new creature dominating automotive shops, farms and worksites across the country. Introducing the Flexzilla® 20V Cordless Grease Gun Kit. It proves what can be accomplished when you combine over 30 years of grease gun experience from Legacy Manufacturing with the extreme performance of Flexzilla.



L1388LFZ

CLICK HERE
to see Flexzilla® Grease Guns in action!

GREASE GUN FEATURES:

- Rapid Reload™ Push Button Technology
 - For fast cartridge loading and unloading
 - Includes lightweight threadless grease barrel
- Flexzilla Grease Hose - 42 in.
 - Extreme cold-weather flexibility (subzero to 140°F)
 - Non-kink bend restrictor
- LED Light - Illuminate workspace
- Ergonomic Grip
- Non-slip Pads - Stabilize gun when standing up and laying on its side. Ideal for tight spaces
- Hose Dock - Secure and manage hose
- Lightweight Aluminum Barrel with Firm Grip Knurling - For better grip and durability
- Positive T-Grip Follower Handle
- Pressure Relief Valve
- 4-Jaw Coupler - Provides quality connection, disconnection, and sealing to zerk
- Holds 14 oz. Grease Cartridge (Cartridge not included)
- Delivers up to 7,000 psi

RAPID RELOAD™ PUSH BUTTON TECHNOLOGY

- For fast cartridge loading
- (Patent Pending)



1 Press to release barrel



2 Slide barrel out to reload

L1388LFZ KIT INCLUDES:

- Flexzilla 20V Cordless Grease Gun
- Flexzilla Grease Hose - 42 in.
- (2) 20V Lithium-Ion Rechargeable Batteries
- 1-Hour Quick Charger
- Automatic Air Bleeder
- 4-Jaw Coupler
- Shoulder Strap
- Carrying Case



L1388LFZ in Case



L1388LFZ-C

Part No.	Description	Retail Packaging
L1388LFZ	Flexzilla® 20V Cordless Grease Gun Kit	●
L1388LFZ-B	Flexzilla® 20V Lithium-Ion Rechargeable Battery for L1388LFZ	●
L1388LFZ-C	Flexzilla® 20V Lithium-Ion 1-Hour Quick Charger for L1388LFZ-B	●

Lever Action Grease Gun

The highest standards of engineering and craftsmanship are built into every Flexzilla® Grease Gun making them the choice for those who work in rugged conditions. Flexzilla Grease Hoses are more flexible than traditional rubber or thermoplastic hoses and stay flexible, even in subzero temperatures.

Heavy Duty Lever Action Grease Gun - Variable Stroke



FEATURES:

- Flexzilla 18 in. Grease Hose - Extreme cold-weather flexibility (subzero to 140°F)
- Soft Barrel Grip - Provides better ergonomic control and comfort
- Heavy-Duty Cast Head Construction - For maximum durability and longer service life
- Durable Follower Rod And Spring - For consistent priming
- Bleeder Valve - For purging unwanted air
- Variable Stroke - Allows grease delivery in confined areas
- 4-Jaw Coupler - Provides quality connection, disconnection, and sealing to zerk
- 3-Way Loading - Cartridge, bulk, filler nipple
- Wide Grip Clearance
- Holds 14 oz. Grease Cartridge
- Includes 6 in. angled extension

Part No.	Retail Packaging
L1355FZ	●

Quick-Release Grease Coupler

The Flexzilla™ Quick-Release Grease Coupler features a patented, innovative design which enables quick and easy connections to grease fittings, even in tight spaces. The Quick-Release Grease Coupler features a spring latch for positive engagement and allows for one-handed operation. When the fitting becomes pressurized, depress the thumb lever and release the coupler. No more stuck on couplers and broken grease fittings. Plus, the Quick-Release Grease Coupler eliminates grease spurts when disconnecting, keeping your workspace clean.

FEATURES:

- 6-Jaw Coupler with high strength steel jaws provide improved clamping force on the zerk
- Releases easily under high pressure
- Spring latch for positive engagement
- Ergonomic thumb lever provides effortless one-handed coupling and uncoupling, even under pressure - no more struggling when removing coupler
- Compact design is ideal for use in tight spaces, 2.9 in. long by 1.2 in. tall
- Compatible with all sizes and forms of mounts, fits all SAE and metric zerk fittings
- For use with most manual, battery and air operated grease guns and pumps
- Patented design



Part No.	FNPT Fitting	Retail Packaging
L2050FZ	1/8 in.	●

*Grease hose not included

Grease Hoses

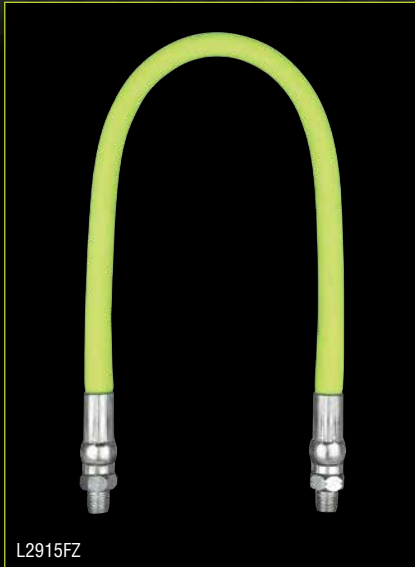

L2915FZ



L2915FZSP

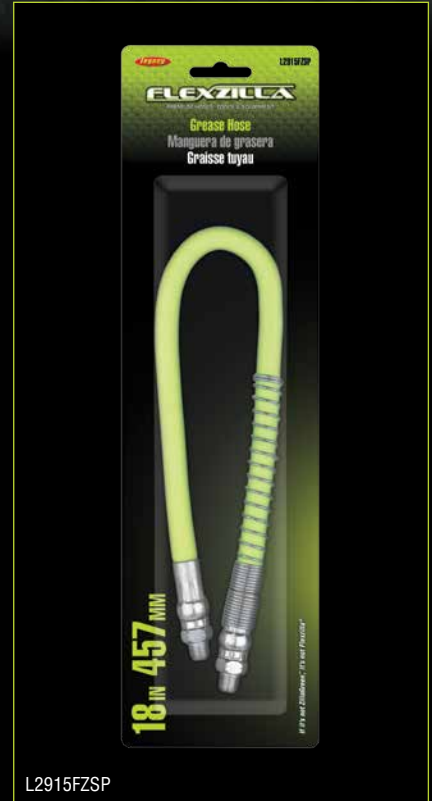

L2915FZSP

Flexzilla™ Grease Hoses are more flexible than traditional rubber or thermoplastic hoses and stay flexible, even in subzero temperatures.

FEATURES:

- Extreme cold-weather flexibility
- 10,000 psi working pressure
- For use with manual, battery or air operated grease guns
- Coupler sold separately

Part No.	Description	Hose I.D.	Hose Length	MNPT Fitting	Spring Guard	Retail Packaging
L2910FZ	Flexzilla® 12 in. Grease Hose	3/16 in.	12 in.	1/8 in.	–	●
L2910FZSP	Flexzilla® 12 in. Grease Hose w/ Spring Guard	3/16 in.	12 in.	1/8 in.	Yes	●
L2915FZ	Flexzilla® 18 in. Grease Hose	3/16 in.	18 in.	1/8 in.	–	●
L2915FZSP	Flexzilla® 18 in. Grease Hose w/ Spring Guard	3/16 in.	18 in.	1/8 in.	Yes	●
L2925FZ	Flexzilla® 36 in. Grease Hose	3/16 in.	36 in.	1/8 in.	–	●
L2925FZSP	Flexzilla® 36 in. Grease Hose w/ Spring Guard	3/16 in.	36 in.	1/8 in.	Yes	●
L2930FZSP	Flexzilla® 42 in. Grease Hose w/ Spring Guard	3/16 in.	42 in.	1/8 in.	Yes	●
L2950FZ	Flexzilla® 12 in. Grease Hose	1/8 in.	12 in.	1/8 in.	–	●
L2950FZSP	Flexzilla® 12 in. Grease Hose w/ Spring Guard	1/8 in.	12 in.	1/8 in.	Yes	●
L2955FZ	Flexzilla® 18 in. Grease Hose	1/8 in.	18 in.	1/8 in.	–	●
L2955FZSP	Flexzilla® 18 in. Grease Hose w/ Spring Guard	1/8 in.	18 in.	1/8 in.	Yes	●
L2965FZ	Flexzilla® 36 in. Grease Hose	1/8 in.	36 in.	1/8 in.	–	●
L2965FZSP	Flexzilla® 36 in. Grease Hose w/ Spring Guard	1/8 in.	36 in.	1/8 in.	Yes	●

EXTREME FLEXIBILITY

Flexzilla® Gloves have been reengineered using carefully selected materials to ensure extreme flexibility.

WORK GLOVES

A GLOVE FOR EVERY JOB

From light-duty gardening to heavy-duty automotive or construction projects. Flexzilla Gloves are available in a wide variety of sizes and styles for any job.

NEW HIGH DEXTERITY **Impact HD Pro Gloves**

Redesigned from cuff to finger tips, Flexzilla® Gloves have been reengineered using carefully selected materials to ensure extreme flexibility, rugged durability and unrivaled comfort. Flexzilla has you covered, from light-duty gardening to heavy-duty automotive or construction projects. Flexzilla Gloves are available in a wide variety of sizes and styles for any job.



GH700P FEATURES:

- Thermoplastic Rubber (TPR) knuckle and finger impact protection
- Touchscreen technology – Thumb, index and middle fingers
- Durable, padded synthetic leather palm
- PVC palm padding
- Breathable 4-Way spandex – Keeps hands cool and comfortable
- Reinforced wear points: Fingertips and thumb saddle
- Terry cloth brow wipe
- Lycra panels between fingers for superior breathability
- Contoured neoprene wrist
- Adjustable Thermoplastic Rubber (TPR) wrist closure and pull tab for secure fit
- Machine washable – Lay flat to dry

**TPR KNUCKLE AND FINGER
IMPACT PROTECTION**

IDEAL FOR: Heavy Equipment, Construction, Demolition, Automotive, Towing

Part No.	Size	Men's
GH700PM	M	●
GH700PL	L	●
GH700PXL	XL	●
GH700PXXL	XXL	●

NEW

HIGH DEXTERITY Utility Gloves

GH100 FEATURES:

- Touchscreen technology – Thumb, index and middle fingers
- Durable, padded synthetic leather palm
- Breathable 4-Way spandex – Keeps hands cool and comfortable
- Padded knuckle reinforcement
- Reinforced wear points: Fingertips and thumb saddle
- Lycra panels between fingers for superior breathability
- Shirred elastic wrist
- Thermoplastic Rubber (TPR) pull tab
- Machine washable – Lay flat to dry

IDEAL FOR: General Tasks

Part No.	Size	Men's
GH100M	M	●
GH100L	L	●
GH100XL	XL	●
GH100XXL	XXL	●



NEW

HIGH DEXTERITY General Purpose Gloves

GH300 FEATURES:

- Touchscreen technology – Thumb, index and middle fingers
- Durable, padded synthetic leather palm
- Breathable 4-Way spandex – Keeps hands cool and comfortable
- Padded knuckle reinforcement
- Reinforced wear points: Fingertips and thumb saddle
- Terry cloth brow wipe
- Neoprene wrist
- Lycra panels between fingers for superior breathability
- Adjustable Thermoplastic Rubber (TPR) wrist closure and pull tab for secure fit
- Machine washable – Lay flat to dry

IDEAL FOR: Multipurpose, Maintenance, Equipment, DIY

Part No.	Size	Men's
GH300M	M	●
GH300L	L	●



NEW HIGH DEXTERITY Fingerless Gloves

GH330 FEATURES:

- Finger pulls for quick and easy glove removal
- Polyurethane non-slip grip palm and thumb back
- Lightweight Lycra back – Keeps hands cool and comfortable
- 4-Way spandex knuckle reinforcement
- Terry cloth brow wipe
- Neoprene wrist
- Adjustable Thermoplastic Rubber (TPR) wrist closure and pull tab for secure fit
- Machine washable – Lay flat to dry

QUICK & EASY GLOVE REMOVAL FINGER PULLS

IDEAL FOR: Cross-functional, Mechanic, Sports

Part No.	Size	Men's
GH330M	M	●
GH330XXL	XXL	●



NEW HIGH DEXTERITY FlexFit Gloves

GH360 FEATURES:

- Touchscreen technology - All fingers
- Durable, padded polyurethane palm - Extreme comfort and tactility
- Flexible spandex – Keeps hands cool and comfortable
- Back of finger PVC reinforcement
- Lycra panels between fingers for superior breathability
- Contoured neoprene wrist
- Adjustable Thermoplastic Rubber (TPR) wrist closure and pull tab for secure fit
- Machine washable – Lay flat to dry

IDEAL FOR: Cross-functional, Mechanic, Sports, Driving

Part No.	Size	Men's
GH360M	M	●
GH360L	L	●
GH360XL	XL	●
GH360XXL	XXL	●



NEW

HIGH DEXTERITY Zillanator™ Pro Gloves



GH361P FEATURES:

- Touchscreen technology – Thumb, index and middle fingers
- Durable, padded synthetic leather palm
- Breathable 4-Way spandex – Keeps hands cool and comfortable
- Padded knuckle reinforcement
- Reinforced wear points: Fingertips and thumb saddle
- Terry cloth brow wipe
- Neoprene wrist
- Adjustable Thermoplastic Rubber (TPR) wrist closure and pull tab for secure fit
- Machine washable – Lay flat to dry

IDEAL FOR: Multipurpose, Mechanic, Contractor

Part No.	Size	Men's
GH361PM	M	●
GH361PL	L	●
GH361PXL	XL	●
GH361PXXL	XXL	●

NEW HIGH DEXTERITY Reflector Pro Gloves

GH400P FEATURES:

- 3M™ Scotchlite™ Reflective Material on knuckle and fingertips
- Touchscreen technology – Thumb, index and middle fingers
- Durable, padded synthetic leather palm
- Breathable 4-Way spandex – Keeps hands cool and comfortable
- Padded knuckle reinforcement
- Reinforced wear points: Fingertips and thumb saddle
- Terry cloth brow wipe
- Lycra panels between fingers for superior breathability
- Contoured neoprene wrist
- Adjustable Thermoplastic Rubber (TPR) wrist closure and pull tab for secure fit
- Machine washable – Lay flat to dry



3M™ SCOTCHLITE™

REFLECTIVE MATERIAL

IDEAL FOR: Safety, Emergency, Construction, Towing

Part No.	Size	Men's
GH400PM	M	●
GH400PL	L	●
GH400PXL	XL	●

NEW HIGH DEXTERITY Water-Resistant Hybrid Grain Leather Pro Gloves

GH460P FEATURES:

- Water-resistant hybrid grain leather palm
- Touchscreen technology – Thumb, index and middle fingers
- Breathable 4-Way spandex – Keeps hands cool and comfortable
- Durable, padded hybrid grain leather knuckle reinforcement
- Reinforced wear points: Fingertips and leather thumb saddle
- Terry cloth brow wipe
- Lycra panels between fingers for superior breathability
- Adjustable Thermoplastic Rubber (TPR) wrist closure and pull tab for secure fit



IDEAL FOR: Construction, Contractor, Landscaping

Part No.	Size	Men's
GH460PM	M	●
GH460PL	L	●
GH460PXL	XL	●

NEW

HIGH DEXTERITY

General Purpose Winter Gloves

GH500 FEATURES:

- **Hand warmer pocket inside – Keeps hands warm and comfortable**
- 3M™ Thinsulate™ liner – 70g
- Touchscreen technology – Thumb, index and middle fingers
- Durable, padded synthetic leather palm
- Breathable 4-Way spandex
- Padded knuckle reinforcement
- Reinforced wear points: Fingertips and thumb saddle
- Lycra panels between fingers for superior breathability
- Shirred elastic wrist
- Thermoplastic Rubber (TPR) pull tab
- Machine washable – Lay flat to dry

3M™ THINSULATE™ LINER – 70G

KEEPS HANDS WARM

IDEAL FOR: General Tasks, Maintenance, DIY

Part No.	Size	Men's
GH500L	L	●
GH500XL	XL	●



NEW

HIGH DEXTERITY

Multipurpose Winter Gloves

GH501 FEATURES:

- **Hand warmer pocket – Keeps hands warm and comfortable**
- 3M™ Thinsulate™ liner – 70g
- Touchscreen technology – Thumb, index and middle fingers
- Durable, padded synthetic leather palm
- Breathable 4-Way spandex
- Padded knuckle reinforcement
- Reinforced wear points: Fingertips and thumb saddle
- Terry cloth brow wipe
- Lycra panels between fingers for superior breathability
- Adjustable Thermoplastic Rubber (TPR) wrist closure and pull tab for secure fit
- Machine washable – Lay flat to dry

3M™ THINSULATE™ LINER – 70G

KEEPS HANDS WARM

IDEAL FOR: Multipurpose, Maintenance, Equipment, DIY

Part No.	Size	Men's
GH501L	L	●
GH501XL	XL	●



NEW

HIGH DEXTERITY Utility Garden Gloves

WOMEN

GH201 FEATURES:

- Touchscreen technology – Thumb, index and middle fingers
- Durable, padded synthetic leather palm
- Breathable 4-Way spandex – Keeps hands cool and comfortable
- Padded knuckle reinforcement
- Reinforced wear points: Fingertips and thumb saddle
- Lycra panels between fingers for superior breathability
- Shirred elastic wrist
- Thermoplastic Rubber (TPR) pull tab
- Machine washable – Lay flat to dry

IDEAL FOR: Garden, Landscaping, General Tasks

Part No.	Size	Women's
GH201S	S	●
GH201M	M	●
GH201L	L	●



NEW

HIGH DEXTERITY General Purpose Garden Gloves

WOMEN

GH202 FEATURES:

- Touchscreen technology – Thumb, index and middle fingers
- Durable, padded synthetic leather palm
- Breathable 4-Way spandex – Keeps hands cool and comfortable
- Padded knuckle reinforcement
- Reinforced wear points: Fingertips and thumb saddle
- Neoprene wrist
- Lycra panels between fingers for superior breathability
- Adjustable Thermoplastic Rubber (TPR) wrist closure and pull tab for secure fit
- Machine washable – Lay flat to dry

IDEAL FOR: Garden, Landscaping, General Tasks

Part No.	Size	Women's
GH202S	S	●
GH202M	M	●
GH202L	L	●



MEN'S SIZING COATED-PALM DIP GLOVES



NEW PALM-COATED DIP **ZillaGrip™ Polyurethane Dip Gloves**



GC300 FEATURES:

- Durable and abrasion-resistant polyurethane palm coating
- Excellent grip on wet and oily surfaces
- Superior comfort
- Breathable 100% polyester shell
- Elastic band cuff keeps out dirt and debris
- Machine washable – Lay flat to dry

**EXCELLENT GRIP
WET & OILY SURFACES**

IDEAL FOR: Automotive, Mechanical, Equipment, Power & Hand Tools

AVAILABLE IN SINGLE & 2-PAIR PACKS

Part No.	Size	Men's
GC300M	M	●
GC300L	L	●
GC300M-2X	M	●
GC300L-2X	L	●
GC300XL-2X	XL	●

NEW PALM-COATED DIP Nitrile Dip Gloves

GC100 FEATURES:

- Touchscreen technology – All fingers
- Durable and abrasion-resistant nitrile palm coating
- Excellent grip on oily surfaces
- Breathable 100% polyester shell
- Elastic band cuff keeps out dirt and debris
- Machine washable – Lay flat to dry

IDEAL FOR: Automotive, Mechanical, Equipment, Power & Hand Tools, General Purpose, DIY

AVAILABLE IN SINGLE & 6-PAIR PACKS

Part No.	Size	Men's
GC100L	L	●
GC100XL	XL	●
GC100L-6X	L	●
GC100XL-6X	XL	●
GC100L-6X-12Q	L	●
GC100XL-6X-12Q	XL	●

Part nos. with a -12Q suffix include (12) 6-Pair Packs in a retail merchandiser display



NEW PALM-COATED DIP Cut-Resistant Pro Sandy Nitrile Dip Gloves

GC160P FEATURES:

- 360° ANSI level 5 cut-resistance protects hands
- Breathable 100% polyester shell
- Touchscreen technology – All fingers
- Durable and abrasion-resistant sandy nitrile palm coating
- Non-slip grip in wet, dry and oily conditions
- Elastic band cuff keeps out dirt and debris
- Machine washable – Lay flat to dry

CUT-RESISTANT

360° ANSI LEVEL 5

IDEAL FOR: Safety, Glass, Power Tools, Handling Blades & Knives, Handling Broken Glass, Maintenance & Repair, Equipment Operation, Landscaping, DIY, Manufacturing, Construction

Part No.	Size	Men's
GC160PL	L	●
GC160PXL	XL	●



NEW

PALM-COATED DIP

Impact Pro Sandy Nitrile Dip Gloves



GC161P FEATURES:

- Thermoplastic Rubber (TPR) knuckle and finger protection
- Touchscreen technology – All fingers
- Durable and abrasion-resistant sandy nitrile palm coating
- Non-slip grip in wet, dry and oily conditions
- Breathable 100% polyester shell
- Elastic band cuff keeps out dirt and debris
- Machine washable – Lay flat to dry

TPR KNUCKLE AND FINGER

IMPACT PROTECTION

IDEAL FOR: Automotive, Mechanical, Equipment, Power & Hand Tools, Construction, Demolition

Part No.	Size	Men's
GC161PL	L	●
GC161PXL	XL	●

NEW **PALM-COATED DIP** **Foam Latex Dip Gloves**

GC220 FEATURES:

- Durable and abrasion-resistant foam latex palm coating
- Breathable polyester shell
- Textured for enhanced durability and grip
- Elastic band cuff keeps out dirt and debris
- Machine washable – Lay flat to dry

TEXTURED PALM COATING

ENHANCED DURABILITY & GRIP

IDEAL FOR: Automotive, Mechanical, Power & Hand Tools, General Purpose, DIY

Part No.	Size	Men's
GC220L	L	●
GC220XL	XL	●



NEW **PALM-COATED DIP** **Crinkle Latex Dip Gloves**

GC240 FEATURES:

- Durable and abrasion-resistant crinkle latex palm coating
- Heavy texture channels away liquids to keep a positive grip
- Excellent grip on wet and dry surfaces
- Breathable 100% polyester shell
- Elastic band cuff keeps out dirt and debris
- Machine washable – Lay flat to dry

WET & DRY SURFACES

EXCELLENT GRIP

IDEAL FOR: Garden, Landscaping, Power & Hand Tools, DIY

Part No.	Size	Men's
GC240L	L	●
GC240XL	XL	●



NEW

PALM-COATED DIP 3/4 Crinkle Latex Dip Pro Gloves



GC241P FEATURES:

- Durable and abrasion-resistant 3/4 crinkle latex palm dip
- Heavy texture channels away liquids to keep a positive grip
- Excellent grip on wet and dry surfaces
- Breathable 100% polyester shell
- Elastic band cuff keeps out dirt and debris
- Machine washable – Lay flat to dry

EXCELLENT GRIP

WET & OILY SURFACES

IDEAL FOR: Automotive, Construction, DIY

Part No.	Size	Men's
GC241PM	M	●
GC241PL	L	●
GC241PXL	XL	●

WOMEN'S SIZING COATED-PALM DIP GLOVES



ZILLAGREEN = SMALL



WHITE = MEDIUM



BLACK = LARGE

NEW

PALM-COATED DIP Foam Latex Dip Garden Gloves

WOMEN

GC221 FEATURES:

- Durable and abrasion-resistant foam latex palm coating
- Breathable polyester shell
- Textured for enhanced durability and grip
- Elastic band cuff keeps out dirt and debris
- Machine washable – Lay flat to dry

IDEAL FOR: Garden, Landscaping, General Tasks

TEXTURED PALM COATING

ENHANCED DURABILITY & GRIP

Part No.	Size	Women's
GC221M	M	●
GC221L	L	●



NEW

PALM-COATED DIP Bamboo Crinkle Latex Dip Garden Gloves

WOMEN

GC290 FEATURES:

- Sustainable bamboo shell with nylon and lycra fibers
- Naturally cool and comfortable
- Crinkle latex palm coating
- Textured channels away liquids and to a keep positive grip
- Elastic band cuff keeps out dirt and debris
- Machine washable – Lay flat to dry

IDEAL FOR: Garden, Landscaping, General Tasks

SUSTAINABLE BAMBOO SHELL

COOL & COMFORTABLE

Part No.	Size	Women's
GC290M	M	●
GC290L	L	●



NEW

PALM-COATED DIP

3/4 Nitrile Dip Winter Gloves

GC180 FEATURES:

- 3/4 Nitrile coating – Textured and double dipped for water resistance
- Heavyweight napped terry knit shell with acrylic lining
- 15-Gauge nylon and high polyethylene outer liner
- Durable and abrasion-resistant with excellent grip on oily surfaces
- Elastic band cuff keeps out dirt and debris
- Machine washable – Lay flat to dry

OILY SURFACES

EXCELLENT GRIP

IDEAL FOR: Automotive, Mechanical, Equipment, Power & Hand Tools, General Purpose, DIY

Part No.	Size	Men's
GC180L	L	●
GC180XL	XL	●



NEW

PALM-COATED DIP

Full Nitrile Dip Winter Gloves

GC181 FEATURES:

- Full nitrile coating – Textured and double dipped for water resistance
- Heavyweight napped terry knit shell with acrylic lining
- 15-Gauge nylon and high polyethylene outer liner
- Durable and abrasion-resistant with excellent grip on oily surfaces
- Elastic band cuff keeps out dirt and debris
- Machine washable – Lay flat to dry

TEXTURED & DOUBLE DIPPED

WATER-RESISTANT COATING

IDEAL FOR: Automotive, Mechanical, Equipment, Power & Hand Tools, General Purpose, DIY

Part No.	Size	Men's
GC181L	L	●
GC181XL	XL	●



HEAVY DUTY CLEANING

NEW Neoprene Long Cuff Pro Gloves

GC400P FEATURES:

- Reusable neoprene material for multiple wears
- Protects against hazardous materials
- Raised non-slip pattern palm and fingertips
- Cotton flocked interior lining for comfort and easy on and off flexibility
- 13 in. long cuff design protects wrists and forearms
- Water-resistant

IDEAL FOR: Chemical Processing, Commercial, Degreasing, Fishing, Galvanizing, General Purpose, Oil Handling, Petrochemical, Mechanical

PROTECTS WRISTS & FOREARMS AGAINST HAZARDOUS MATERIALS

Part No.	Size	Men's
GC400PM	M	●
GC400PL	L	●
GC400PXL	XL	●



HEAVY DUTY CLEANING

NEW PVC Long Cuff Pro Gloves

GC500P FEATURES:

- Reusable food grade PVC material for multiple wears
- Protects against hazardous materials
- Non-slip textured palm
- Cotton interior lining for comfort and easy on and off flexibility
- 12 in. long cuff design protects wrists and forearms
- Water-resistant

IDEAL FOR: Degreasing, Acids & Caustics, Agriculture, Construction, Chemical Handling, Food, General Maintenance, Oil Handling, Petrochemical

BUILT FOR MULTIPLE WEARS FOOD GRADE PVC

Part No.	Size	Men's
GC500PL	L	●
GC500PXL	XL	●



NEW

LEATHER

Grain Leather Gloves

FEATURES:

- Grain leather construction
- Excellent comfort and unimpeded dexterity
- Naturally durable and breathable
- Withstands moisture without becoming stiff
- Reinforced suede palm patch
- Keystone thumb design
- Shirred elastic wrist

EXCELLENT COMFORT

UNIMPEDED DEXTERITY

IDEAL FOR: Construction, Contractor, Landscaping, Garden, General Tasks

Part No.	Size	Men's	Women's
GL20M	M	●	
GL20L	L	●	
GL20XL	XL	●	



PLAN-O-GRAMS

ONE-STOP SHOP

All the high-performance tools you need for that big project in one spot.

Water Hoses, Reels and Nozzles



Items Shown:

- Garden Hose Nozzles
- 3-Piece Nozzle Kit with Quick Connections
- Quick-Connect Garden Hose Fittings
- Pro Water Hose Nozzles
- Garden Lead-in Hoses
- Pressure Washer Hoses
- SwivelGrip® Garden Hoses
- Garden Hoses
- Garden Hose Kits with Quick Connect Attachments
- Pro Water Hoses – Field Repairable
- Water Hose Reels

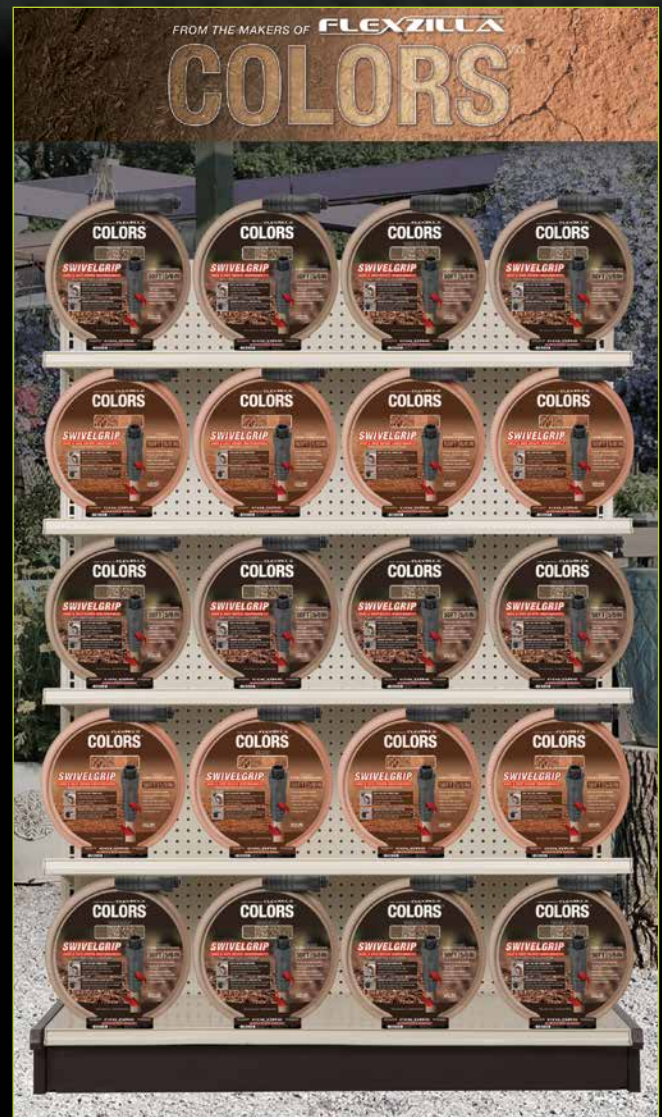

Items Shown:

- Colors™ SwivelGrip® Garden Hoses
- Available in Colors:
 - Brown Mulch
 - Red Clay

Greasing Equipment, Blow Guns and Assorted Products



Items Shown:

- Grease Hoses
- Grease Guns – Lever Action
- Grease Guns – 20V Cordless Kit



Items Shown:

- Blow Guns and Kits
- Pro Extension Cords
- 11-Piece Air Hose Compressor Kits
- Truck Tire Inflator Kits
- Air Hose Reels with Levelwind™ Technology
- Extension Cord Reels

Air Tool Kits, Hoses and Assorted Products



Items Shown:

- Recoil Hoses
- Whip Hoses
- Tire Inflators
- Pro High Flow Couplers and Plugs
- Pro Reusable Fittings and Splicers
- Air Hoses
- Pro Air Hoses – Field Repairable
- Air Hose Reels
- Extension Cord Reels



Items Shown:

- Pro High Flow Couplers and Plugs
- Pro Custom Length Whip Hoses
- Pro Mini Impact Wrench
- Pro Air Hoses – Field Repairable

Hose Reel Display Rack, Reels, and Air Hoses

Items Shown:

- Gondola Mounted Hose Reel Display Rack (HR-20)
- Air Hoses
- Air Hose Reels

Gondola Mounted Hose Reel Display Rack:

Allows up to five Legacy or Flexzilla reels to be mounted for in-store display.

COMPATIBLE WITH 4 FT. LOZIER GONDOLA SHELVING

SIDE PROFILE

MEASUREMENTS:

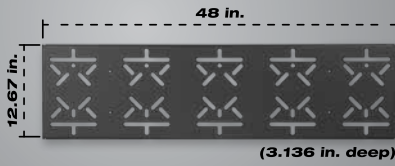

HR-20 FEATURES:

- Unique mounting patterns accommodate any Legacy or Flexzilla hose reel
- Interlocking tabs compatible with 4 ft. Lozier gondola shelving uprights
- Secondary mount holes for attaching to other structures



Work Gloves

Items Shown:

- Garden Gloves
- Leather Gloves
- High Dexterity Gloves
- Winter Gloves
- Palm-Coated Dip Gloves
- Gloves PDQs

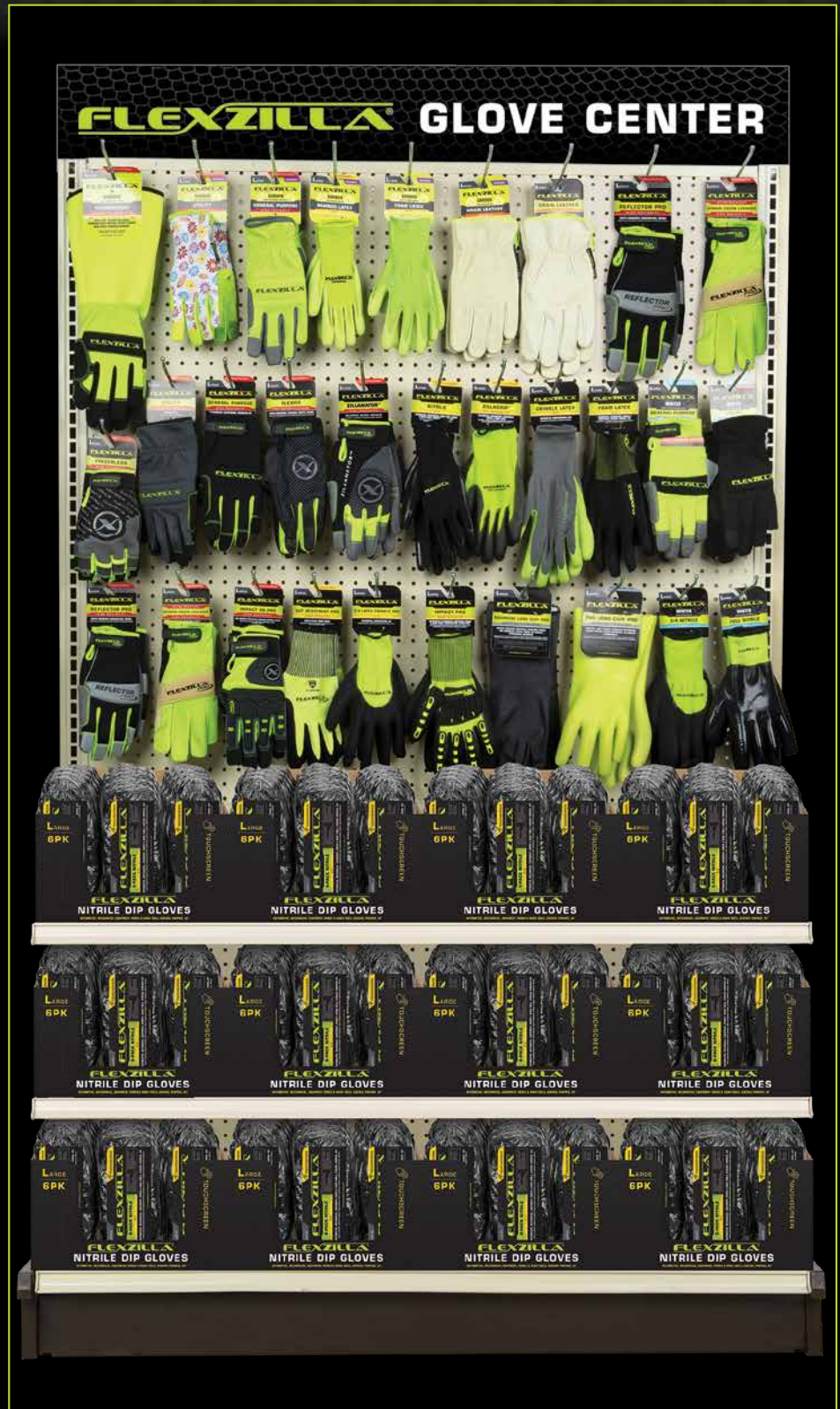

Custom Hose Centers

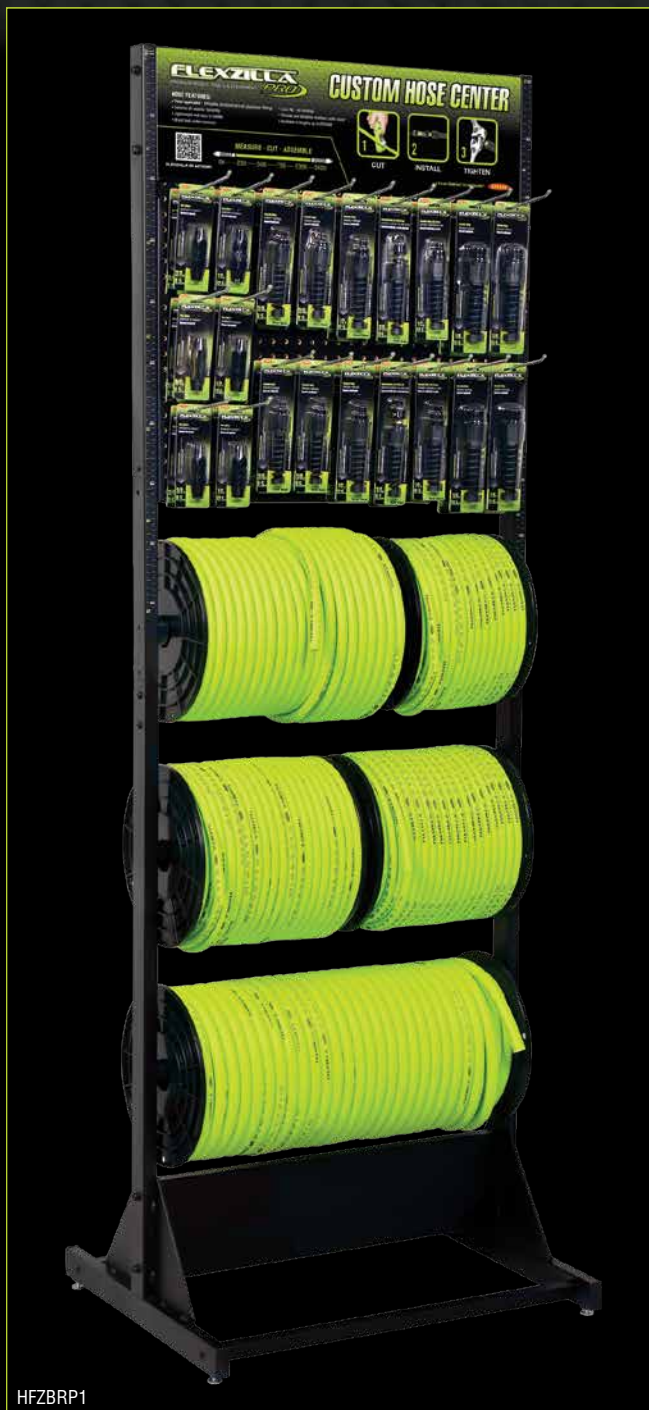

HFZBRP1

Items Shown:

- Reusable Fittings and Splicers
- Bulk Air Hose
- Bulk Water Hose



HFZBRP3

Items Shown:

- Reusable Fittings and Splicers
- Bulk Air Hose
- Bulk Water Hose

Custom Water Hose Centers



Items Shown:

- Reusable Water Fittings
- SwivelGrip® Lead-in Hoses
- Bulk Water Hose

INDEX

Part No.	Pg.	Part No.	Pg.	Part No.	Pg.
A5	17	AG1006FZ	43	FS10V080V1	10
A53416FZ	37	AG1012FZ	43	FS10V120V1	10
A53416FZ-X	37	AG1016FZ-N	43	FXS07V080V1	9
A53426FZ	37	AG1090FZ	43	FXS07V080V3-208	9
A53426FZ-X	37	AG1091FZ	43	FXS07V080V3-230	9
A53430FZ-2PK	37	AG1092FZ	43	FXS10V080V1	9
A53430FZ-X	37	AG1093FZ	43	FXS10V080V3-208	9
A53440FZ-2PK	37	AG1099FZ	43	FXS10V080V3-230	9
A53440FZBS	37	AG1102FZ	42	FXS10V120V1	9
A53440FZBS-X	37	AG1200FZKIT	42	FXS10V120V3-208	9
A53440FZ-X	37	AG1202FZ	42	FXS10V120V3-230	9
A53452FZ	38	AG1402FZ	42	FZ512725	64
A53457FZ	38	AG1500FZKIT	42	FZ512730	64
A53458FZ	38	AG1502FZ	42	FZ512735	64
A53616FZ	37	AG934FZ	43	FZ512825	64
A53616FZ-X	37	AL2000FZ	47	FZ512830	64
A53626FZ	37	AL2025FZ-1	47	FZ512835	64
A53626FZ-X	37	AL2025FZ-2	47	FZ512930	64
A53630FZ-2PK	37	AT1475FZ	45	FZ512935	64
A53630FZ-X	37	CB20100F	12	FZ8120603	66
A53640FZ-2PK	37	CB20200F	12	FZ8140503	65
A53640FZ-X	37	CF10050F	12	FZ8160253	65
A53657FZ	38	DRAIN013	11	GC100L	80
A55618FZ	40	FDRCF1150030	11	GC100L-6X	80
A55628FZ	40	FDRCF1150058	11	GC100L-6X-12Q	80
A55630FZ	40	FILTER057	11	GC100XL	80
A55640FZ	40	FILTER107KIT	11	GC100XL-6X	80
A55656FZ	40	FILTERKIT011	11	GC100XL-6X-12Q	80
A55818FZ	40	FILTERKIT012	11	GC160PL	80
A55828FZ	40	FKIT011A	11	GC160PXL	80
A55830FZ	40	FKIT026A	11	GC161PL	81
A55840FZ	40	FS050V80Y1	10	GC161PXL	81
A55856FZ	40	FS05V080I1	9	GC180L	85
A86666FZ	38	FS07V080Y1	10	GC180XL	85

Part No.	Pg.	Part No.	Pg.	Part No.	Pg.
GC181L	85	GH300M	73	HFZ1208YW3S	16
GC181XL	85	GH330M	74	HFZ12100YW3	14
GC220L	82	GH330XXL	74	HFZ12100YW4	14
GC220XL	82	GH360L	74	HFZ12250YW	20, 21
GC221L	84	GH360M	74	HFZ1225YW3	14
GC221M	84	GH360XL	74	HFZ1250YW3	14
GC240L	82	GH360XXL	74	HFZ1250YW4	14
GC240XL	82	GH361PL	75	HFZ1405YW2B	16
GC241PL	83	GH361PM	75	HFZ14100YW2	14
GC241PM	83	GH361PXL	75	HFZ14100YW2-3X	14
GC241PXL	83	GH361PXXL	75	HFZ14100YW2-D	15
GC290L	84	GH400PL	76	HFZ14250YW	20, 21
GC290M	84	GH400PM	76	HFZ1425YW2	14
GC300L	79	GH400PXL	76	HFZ1425YW2-D	15
GC300L-2X	79	GH460PL	76	HFZ1450YW2	14
GC300M	79	GH460PM	76	HFZ1450YW2-D	15
GC300M-2X	79	GH460PXL	76	HFZ3802YW2B	16
GC300XL-2X	79	GH500L	77	HFZ3804YW2B	16
GC400PL	86	GH500XL	77	HFZ3806YW2B	16
GC400PM	86	GH501L	77	HFZ38100YW2	14
GC400PXL	86	GH501XL	77	HFZ38100YW2-D	15
GC500PL	86	GH700PL	72	HFZ38250YW	20, 21
GC500PXL	86	GH700PM	72	HFZ3825YW2	14
GH100L	73	GH700PXL	72	HFZ3825YW2-5X	14
GH100M	73	GH700PXXL	72	HFZ3825YW2-D	15
GH100XL	73	GL20L	87	HFZ3835YW2	14
GH100XXL	73	GL20M	87	HFZ3835YW2-D	15
GH201L	78	GL20XL	87	HFZ3850YW2	14
GH201M	78	HFZ1202YW3S	16	HFZ3850YW2-10X	14
GH201S	78	HFZ1202YW4S	16	HFZ3850YW2-3X	14
GH202L	78	HFZ1204YW3S	16	HFZ3850YW2-D	15
GH202M	78	HFZ1204YW4S	16	HFZ3850YW3	14
GH202S	78	HFZ1206YW3S	16	HFZBRP1	19, 94
GH300L	73	HFZ1206YW4S	16	HFZBRP3	19, 94

INDEX

Part No.	Pg.
HFZC550BRS	50
HFZC550TCS	50
HFZCLB11D	16
HFZCLB11D-3X	16
HFZG12050QN	52
HFZG503YW	51
HFZG503YWS	49, 60
HFZG505YW	51
HFZG505YWS	49
HFZG5100YW	51
HFZG5100YW-36T	51
HFZG5100YWS	49
HFZG510YW	51
HFZG510YWS	49, 60
HFZG510YWS-6X	49
HFZG525YW	51
HFZG525YWS	49
HFZG550YW	51
HFZG550YW-48T	51
HFZG550YWS	49
HFZG550YWS-30X	49
HFZG550YWS-40X	49
HFZG575YW	51
HFZG575YW-48T	51
HFZG575YWS	49
HFZG6100YW	51
HFZG650YW	51
HFZG675YW	51
HFZGA60	54
HFZGAK01	52
HFZGAK02	52
HFZGAK11	53
HFZGAK12	53
HFZGAK13	53

Part No.	Pg.
HFZGAK14	53
HFZGSK01	54
HFZP14100YW2	22
HFZP14100YW2-D	23
HFZP1425YW2	22
HFZP1425YW2-D	23
HFZP1450YW2	22
HFZP1450YW2-D	23
HFZP3806YW2B	23
HFZP38100YW2	22
HFZP38100YW2-D	23
HFZP3825YW2	22
HFZP3825YW2-D	23
HFZP3835YW2	22
HFZP3850YW2	22
HFZP3850YW2-D	23
HFZPW3425M	62
HFZPW3425M-4X	62
HFZPW3450M	62
HFZPW3450M-3X	62
HFZPW3525M	62
HFZPW3525M-4X	62
HFZPW3550M	62
HFZPW3550M-3X	62
HFZPW36425M	62
HFZPW36425M-5X	62
HFZPW36450M	62
HFZPW36450M-3X	62
HFZPW40525M	62
HFZPW40525M-5X	62
HFZPW40550M	62
HFZPW40550M-3X	62
HFZPW426050Q	62
HFZPW426050Q-3X	62

Part No.	Pg.
HFZPW426100Q	62
HFZPW426100Q-2X	62
HFZW58250YW	20, 21, 60
HFZWHC1	59, 60, 95
HFZWP5100	60
HFZWP550	60
HFZWP575	60
HGH2-FZ	47
HR-05	20, 60
HR-20	92
ISOLATORS001	11
L1355FZ	69
L1388LFZ	68
L1388LFZ-B	68
L1388LFZ-C	68
L2050FZ	69
L2910FZ	70
L2910FZSP	70
L2915FZ	70
L2915FZSP	70
L2925FZ	70
L2925FZSP	70
L2930FZSP	70
L2950FZ	70
L2950FZSP	70
L2955FZ	70
L2955FZSP	70
L2965FZ	70
L2965FZSP	70
L8011FZ	30
L8011FZLI	34
L8041FZ	30
L8232FZ	27
L8250FZ	27

Part No.	Pg.	Part No.	Pg.
L8250FZLI	34	NFZG52	55
L8251FZP	26	NFZG61	55
L8251FZPLI	34	NFZG62	55
L8300-B	25, 61	NFZG63	55
L8300-W	25, 61	NFZG64	56
L8305FZ	25	NFZG65	56
L8305FZLI	34	NFZG66	56
L8306FZ	25	NFZG67	56
L8335FZ	25	NFZG68	56
L8335FZLI	34	NFZG69	56
L8340FZ	61	NFZG70	57
L8340FZLI	61	OILFZ004	11
L8550FZ	31	OILPIS102Q	11
L8560FZ	31	RP900250	20, 21
L8603FZ	28	RP900250BS	20, 21
L8611FZ	28	RP900250S	21
L8611FZLI	34	RP900375	20, 21
L8650FZ	32	RP900375BS	20, 21
L8651FZ	33	RP900375S	21
L8651FZLI	34	RP900500	20
L8652FZ	32	RP900500S	20, 21
L8654FZ	33	RP900625F	20, 21, 60
L8654FZLI	34	RP900625M	20, 21, 60
L8711FZ	29	RP901250	20, 21
L8741FZ	29	RP901375	20, 21
LP1410AFZ	17	RP901500	20, 21
LP1415AFZ	17	SFZG61	57
LP1420AFZ	17	SFZG62	57
LP1425AFZ	17		
MAINKIT008A	11		
NFZG01-N	57		
NFZG02-N	57		
NFZG21	55		
NFZG51	55		

✓ Air Compressors

✓ Air Hoses

✓ Air Line Accessories

✓ Extension Cords

✓ Greasing Equipment

✓ Modular Blow Guns
& Accessories

✓ Reels

✓ Tire Maintenance

✓ Water Hoses

✓ Work Gloves



FLEXZILLA®

PREMIUM HOSES, TOOLS & EQUIPMENT



See the full line of Flexzilla® products at:

flexzilla.com



Legacy Manufacturing Company

6509 Partners Ave
Marion, IA 52302
phone: 319-373-7305
toll-free: 800-645-8258
email: info@flexzilla.com
legacymfg.com
flexzilla.com

See Flexzilla in Action!

Visit Legacy...



Published: January 1, 2022 Revised June 15, 2022

Flexzilla and The Flexzilla Stylized X both are registered trademarks of Weems Industries, Inc.
The color CHARTREUSE is a registered trademark of Weems Industries, Inc., including but not limited to U.S. Reg. Nos. 4,827,169 & 5,293,921.
SwivelGrip is a registered trademark of Weems Industries, Inc.
SwivelGrip® Patent Pending © Legacy Manufacturing Co.
Colors is a trademark of Weems Industries, Inc.
ColorConnex is a registered trademark of Weems Industries, Inc.
Legacy is a trademark of Weems Industries, Inc.
ColorConnex: U.S. Pat. No. 7,980,599 & 8,430,431 and Canadian Registration No. 2,575,170
Lock-n-Load: U.S. Pat. No. 8,297,476 B2 and Canadian Pat. No. 02743126

Copyright © 2022 Legacy Manufacturing Co. All Rights Reserved.